

HYDRO: EVOLVED

USER MANUAL

VERSION 1.14



SMARTRISE

Document History

Date	Version	Summary of Changes
January 30, 2025	1.14	Reviewed the <i>Types of Inputs</i> subsection under the <i>Assigning Inputs and Outputs</i> section. Reviewed the <i>Disable DOB Rear</i> subsection under the <i>Doors</i> section. Reviewed the <i>Enable Pit Inspection</i> subsection under the <i>Miscellaneous</i> section. Reviewed the <i>Fixed CAM</i> subsection under the <i>Doors</i> section. Reviewed the <i>Setup</i> subsection under the <i>Menu Structures</i> section.
January 29, 2025	1.13	Added the <i>Smartrise Air Mobile Application</i> subsection under the <i>Miscellaneous</i> section.
January 20, 2025	1.12	Added the BYPASS WANDERGUARD NEXT CC input under the <i>Types of Inputs</i> subsection. Added the HOISTWAY LAMP & AT LANDING LAMP outputs under the <i>Types of Outputs</i> subsection. Reviewed the <i>Direction Counter Limit</i> subsection under the <i>Miscellaneous</i> section.
November 5, 2024	1.11	Added the <i>Sequence of Operation</i> section.
September 9, 2024	1.10	Added the BYPASS LWD input under the <i>Types of Inputs</i> subsection.
August 23, 2024	1.9	Added the <i>Split Group Masks</i> subsection to the <i>Hall Network</i> section. Added a note on short floor to the <i>Sensory Array Assembly</i> subsection under the <i>SmartPositioning Landing System</i> section. Added a note on short floor to the <i>Proximity Sensor Assembly</i> subsection under the <i>NEMA 4 Landing System</i> section.
June 17, 2024	1.8	Replaced “S-curve” with “Digital S-curve Technology™ (U.S. Patent Pending)”.
June 3, 2024	1.7	Updated the <i>CPLD</i> subsection under the <i>Status</i> section.
May 27, 2024	1.6	Updated the <i>Logged Faults</i> and <i>Logged Alarms</i> subsections. Added the Active Shooter output. Added the Clear Latched Calls input.
May 20, 2024	1.5	Added the <i>Replay Feature</i> subsection to the <i>Miscellaneous</i> section.
April 17, 2024	1.4	Updated document presentation. Validated & updated the menu structures, LCD displays, tables, document content. Replaced the “Overview” title with “List of Hydro:Evolved Manuals”. Added the <i>NEMA 4 Landing System</i> section. Added the <i>Timed Hall Call Security</i> subsection to the <i>Floors</i> section. Added the <i>Third Valve Board</i> subsection under the <i>Hydro</i> section. Added the <i>Fourth Valve Board</i> subsection under the <i>Hydro</i> section.

Date	Version	Summary of Changes
January 30, 2025	1.14	<p>Reviewed the <i>Types of Inputs</i> subsection under the <i>Assigning Inputs and Outputs</i> section.</p> <p>Reviewed the <i>Disable DOB Rear</i> subsection under the <i>Doors</i> section.</p> <p>Reviewed the <i>Enable Pit Inspection</i> subsection under the <i>Miscellaneous</i> section.</p> <p>Reviewed the <i>Fixed CAM</i> subsection under the <i>Doors</i> section.</p> <p>Reviewed the <i>Setup</i> subsection under the <i>Menu Structures</i> section.</p>
January 29, 2025	1.13	<p>Added the <i>Smartrise Air Mobile Application</i> subsection under the <i>Miscellaneous</i> section.</p>
		<p>Added the <i>Third</i> subsection to the <i>Soft Starter</i> subsection (under the <i>Hydro</i> section).</p> <p>Added the <i>Viscosity</i> subsection under the <i>Hydro</i> section.</p> <p>Added the <i>Low Oil</i> subsection under the <i>Hydro</i> section.</p> <p>Added the <i>Enable Pit Inspection</i> subsection under the <i>Miscellaneous</i> section.</p> <p>Added the <i>Lockout Passcode</i> subsection to the <i>Miscellaneous</i> section.</p> <p>Added the <i>Direction Counter Limit</i> subsection to the <i>Miscellaneous</i> section.</p> <p>Added the <i>Reset Service</i> subsection to the <i>Miscellaneous</i> section.</p> <p>Added the <i>Speed Deviation</i> subsection under the <i>Safety</i> section.</p> <p>Added the <i>Ph1 Recall Floor</i> subsection to the <i>EMS</i> subsection (under the <i>Emergency</i> section).</p> <p>Added the <i>Hall Medical Rear Door Mask</i> subsection to the <i>Hall Network</i> section.</p> <p>Added the <i>Load Weighing Device</i> section.</p> <p>Added the <i>Dynamic Security</i> subsection to the <i>Virtual Inputs</i> subsection (under the <i>Status</i> section).</p> <p>Added the <i>List of Faults</i> subsection to the <i>Faults</i> section.</p> <p>Added the <i>List of Alarms</i> section to the <i>Alarms</i> section.</p> <p>Added the <i>List of Abbreviations</i> section.</p> <p>Added the <i>References</i> section.</p> <p>Updated the <i>Construction Mode</i> section.</p> <p>Updated the <i>Wander Guard</i> section.</p> <p>Updated the <i>EMS</i> section.</p> <p>Updated the <i>Access Code</i> section.</p>
October 1, 2022	1.3	Updated <i>Hydro Slowdown</i> .
July 21, 2022	1.2	Updated <i>Adaptive Slowdown™</i> system (U.S. Patent Pending).
October 20, 2021	1.1	Added the <i>24 Input Board</i> section.
September 9, 2021	1.0	Initial Release.

Table of Contents

1	Hydro:Evolved Controller	1
1.1	List of Hydro:Evolved Manuals	1
1.2	Hydro:Evolved Controller Components	1
1.3	Safety	5
1.4	Default Voltage Settings Prior to Installation	5
2	Controller Hardware	6
2.1	MR Board SR3032	6
2.1.1	Navigation Buttons	8
2.1.2	24 VDC Power Source	9
2.1.3	Reset Buttons.....	10
2.1.4	Normal Terminal Stop.....	10
2.1.5	Network.....	11
2.1.6	120 VAC Inputs and Outputs (Factory).....	12
2.1.7	24 VDC Inputs and Outputs	13
2.1.8	24 VDC Monitoring System	14
2.1.9	Safety String Inputs 120 VAC.....	14
2.1.10	120 VAC Inputs and Outputs (Field)	15
2.1.11	Hall Lock Connections	16
2.1.12	Inspection Controls.....	17
2.1.13	Safety Relays.....	18
2.2	CT/COP Board SR3030	19
2.3	I/O Board/Riser Board SR3031.....	21
2.3.1	Group Redundancy.....	22
2.4	24 Input Board SR3041	23
2.5	Hall Board SR1060	25
2.6	Valve Board SR3045.....	26
3	Menu Structures	28
3.1	Status	28
3.2	Faults and Alarms	31
3.3	Setup.....	32
3.4	Debug and About.....	54

4	High-Level Navigation Menu Structure	57
4.1	Main Menu	57
4.2	Faults.....	59
4.3	Alarms	59
4.4	Setup	59
4.5	Debug	61
5	Parameters.....	63
6	Construction Mode	64
6.1	Main Power Setup	64
6.2	Start Construction Mode	65
6.3	Soft Starter Setup	66
7	Inspection Mode	67
7.1	Standard Modes of Inspection	67
7.2	Inspection Run Options and Adjustments.....	68
8	Adjusting Run Timers	69
9	SmartPositioning Landing System	71
9.1	Coded Tape	71
9.2	Sensor Assembly Installation.....	72
9.3	Upper Tape Mount Assembly	75
9.4	Tape Clip Assembly	77
9.5	Lower Tape Mount Assembly	80
9.6	Sensor Array Assembly	82
9.7	Emergency Tape Break (ETB) Switch Assembly	85
9.8	Fine Tune	87
9.9	Alignment	88
10	NEMA 4 Landing System	90
10.1	Proximity Sensor Assembly.....	90
10.2	Installation.....	92
10.2.1	Mounting Magnetic Tape in the Hoistway	92
10.2.2	Mounting the Sensor to the Car	92
10.2.3	Install Magnetic Tape Through Sensor.....	92
10.3	LEDs	94
11	Learning the Hoistway.....	95
12	Speeds	97

12.1	Contract Speed	97
12.2	Leveling Speed	97
12.3	Test Buffer Speed	98
13	Floors	100
13.1	Number of Floors	100
13.2	Floor Adjustment.....	100
13.2.1	Car is Too High/ Too Low	100
13.3	Security Setting	102
13.4	Access Code	103
13.4.1	Front and Rear Access	103
13.4.2	Offset Floors.....	105
13.4.3	Car Call Button Timer	106
13.5	Enable Releveling	107
13.6	Relevel Zone Size	107
13.7	Releveling Delay	108
13.8	Floor Openings	109
13.9	Wander Guard	109
13.10	Store Floor Level	110
13.11	Short Floor Opening	111
13.12	Timed Car Call Security.....	111
13.13	Timed Hall Call Security	114
14	Sabbath Operation	117
15	Doors.....	124
15.1	Control Doors.....	124
15.2	Door Dwell Timer.....	125
15.3	Hall Dwell Timer	125
15.4	ADA Dwell Timer	126
15.5	Hold Dwell Timer	126
15.6	Lobby Dwell Timer.....	127
15.7	Door Stuck Timer.....	128
15.8	Door Nudge Timer	128
15.9	Rear Doors	129
15.10	PreOpening Distance.....	130
15.11	DC On Run.....	130
15.12	DC On Close	131
15.13	DO On Open	132
15.14	Disable on CT Stop.....	132

15.15	Disable on HA.....	133
15.16	AT400 Doors.....	134
15.17	No Demand Doors Open.....	134
15.18	Jumper Timer.....	135
15.19	Jumper on DOL.....	135
15.20	Hourly Fault Limit.....	136
15.21	Nudge – Buzzer Only.....	137
15.22	Opening Time.....	137
15.23	Check Time.....	138
15.24	Door Type.....	139
15.25	Lock and CAM Timeout.....	139
15.26	Retiring CAM.....	140
15.27	Fixed CAM.....	141
15.28	Swing Lock GSW Timeout.....	141
15.29	Swing Contacts Timeout.....	142
15.30	Disable DOB Rear.....	143
15.31	Front Door State.....	143
15.32	Rear Door State.....	144
16	Car Data.....	146
16.1	Car Data Overview.....	146
16.2	Hall Call Mask Status.....	148
16.3	Opening Map Status.....	149
16.3.1	Front Opening Map Status.....	149
16.3.2	Rear Opening Map Status.....	150
16.4	Security Map Status.....	150
16.4.1	Front Security Map Status.....	150
16.4.2	Rear Security Map Status.....	151
16.5	Linked Hall Mask Status.....	151
16.6	Hall Security Map Status.....	152
16.6.1	Front Hall Security Map Status.....	152
16.6.2	Rear Hall Security Map Status.....	153
16.7	Hall Security Mask Status.....	153
16.8	Dispatching Timer Status.....	154
16.9	VIP Flags.....	155
16.10	VIP Masks.....	156
16.11	Car Call Enable Bitmap Status.....	157
16.11.1	Front Car Call Enable Bitmap Status.....	157
16.11.2	Rear Car Call Enable Bitmap Status.....	158

16.12	Emergency Medical Call Mask and Landing	158
17	Hall Network	160
17.1	CAN Bus	160
17.2	Hall Board Status.....	161
17.3	Enable Hall Security	162
17.4	Hall Security Mask.....	162
17.5	Hall Security Map	163
17.6	Hall Security Status.....	164
17.7	Hall Call Mask	164
17.8	Linked Hall Buttons	165
17.9	Hall Medical Mask	166
17.10	Hall Medical Rear Door Mask	167
17.11	Hall Rear Door Mask.....	168
17.12	Split Group Masks	169
17.13	Errors.....	169
17.14	Compatibility	169
18	Serial Hall Lanterns.....	170
18.1	CAN BUS	170
18.2	Hall Lantern Masks.....	170
18.3	Serial Hall Lantern Status.....	170
18.4	Errors.....	171
19	Hydro.....	172
19.1	Valve Type Select	172
19.2	Secondary Valve Board	172
19.3	Third Valve Board.....	173
19.4	Fourth Valve Board	174
19.5	Soft Starter	174
19.5.1	Primary	175
19.5.2	Secondary	178
19.5.3	Third	181
19.5.4	Run With One Soft Starter	182
19.6	Slowdown.....	183
19.6.1	Level Maximum Run Distance.....	185
19.6.2	NTS Buffer Distance Up and Down	186
19.6.3	Destination and Relevel Offsets.....	187
19.6.4	Speed Thresholds.....	189

19.6.5	Slowdown Distance	189
19.6.6	Slowdown Distance After Adjustments	190
19.6.7	Hydro Speed Setup	191
19.6.8	Adaptive Slowdown™ system (U.S. Patent Pending).....	194
19.6.9	Slowdown Distance After Adjustments	196
19.6.10	TSRD Distance	199
19.7	Battery Test Time.....	199
19.8	Jack Resync Time	200
19.9	Disable NTS Alarm	201
19.10	Viscosity.....	202
19.10.1	Run Time	202
19.10.2	Rest Time	202
19.10.3	Cycles Allowed.....	203
19.10.4	Allow Calls	205
19.11	Low Oil	205
20	Data Acquisition Device Unit	206
20.1	DAD Status.....	206
21	Assigning Inputs and Outputs	207
21.1	Adding an Input or Output.....	207
21.2	Removing an Input or Output.....	208
21.3	Types of Inputs	208
21.4	Types of Outputs	217
21.5	Invert Inputs.....	224
21.6	Invert Outputs.....	225
22	VIP	226
23	Active Shooter.....	227
24	Marshal Mode.....	228
25	Installing a New Board	229
25.1	Retain Parameters for a Replaced MR Board	229
25.2	Retain Parameters for a Replaced CT or COP Board.....	230
26	Hoistway Access.....	231
27	Sequence of Operation	235
27.1	Car Movement.....	235

27.2	Door Operation.....	236
28	Miscellaneous.....	240
28.1	Bypass Term Limit	240
28.2	Enable Construction Box.....	240
28.3	Maximum Run Time.....	241
28.4	CT Insp. Req. IC.....	242
28.5	Dis. IdleTrvArrow	242
28.6	Enable Latches Car Calls	243
28.7	Car To Lobby Floor.....	243
28.8	Enable Pit Inspection.....	244
28.9	Parking.....	244
28.9.1	GUI Parking.....	244
28.9.2	Parking Timer	245
28.9.3	Parking Floor	246
28.9.4	Parking Door Open	247
28.10	OOS.....	247
28.10.1	Disable OOS.....	247
28.10.2	Hourly Fault Limit	248
28.10.3	Maximum Starts Per Minute	249
28.10.4	Disable PI OOS.....	249
28.11	En. 3 Digit PI.....	250
28.12	Payment Passcode	251
28.13	Lockout Passcode	251
28.14	Direction Counter Limit	252
28.15	Direction Change Delay.....	253
28.16	Default.....	254
28.16.1	Default Floors	254
28.16.2	Default S-Curve.....	255
28.16.3	Default Run Timers.....	256
28.16.4	Default I/O	257
28.16.5	Default Other.....	257
28.16.6	Default Factory.....	258
28.16.7	Default FRAM	259
28.17	Reset Service	260
28.18	Replay Feature	260

28.19	Smartrise Air Mobile Application.....	260
29	Swing Operation.....	261
29.1	Configuring Swing Operation Input.....	261
29.2	Calls Enable Swing.....	261
29.3	Swing Opening.....	262
29.4	Swing Call Mask.....	263
29.5	Stay Active in Group.....	263
29.6	Idle Timer.....	264
30	Timers.....	266
30.1	Fan & Light Timer.....	266
30.2	External Fan Timer.....	266
30.3	Arrival Update Time.....	267
31	Safety.....	268
31.1	Speed Deviation.....	268
31.1.1	Timeout.....	268
31.2	Lock Clip.....	269
31.3	General ODL.....	269
31.4	NTS ODL.....	270
31.5	TSRD ODL.....	270
32	Emergency.....	272
32.1	Emergency Power.....	272
32.1.1	Earthquake Modes.....	272
32.1.2	Privileged Modes.....	272
32.1.3	Other Modes.....	273
32.1.4	Single Group Operation.....	273
32.1.5	Multiple Group Operation.....	274
32.1.6	Recall.....	275
32.1.7	Intergroup Communication.....	276
32.2	Earthquake.....	277
32.2.1	Enable Earthquake.....	277
32.2.2	Set CW Position.....	278
32.2.3	Earthquake Status.....	278
32.3	Fire.....	279
32.3.1	Main Recall.....	279

32.3.2	Alternate Recall.....	281
32.3.3	Main Smoke.....	282
32.3.4	Alternate Smoke.....	285
32.3.5	Hoistway Smoke.....	287
32.3.6	MR Smoke.....	290
32.3.7	Recall Key.....	292
32.3.8	PIT Smoke.....	293
32.3.9	Alt Machine Room.....	295
32.3.10	Advanced Configs.....	300
32.4	Flood.....	303
32.4.1	Number of Floors.....	303
32.4.2	Okay to Run.....	303
32.4.3	Override Fire.....	304
32.5	EMS.....	305
32.5.1	AllowPh2WithoutPh1.....	305
32.5.2	Exit Ph2 Any Floor.....	306
32.5.3	Fire Overrides Ph1.....	306
32.5.4	Ph1 Exit Delay.....	307
32.5.5	Ph2 Exit Delay.....	308
32.5.6	Ph1 Recall Floor.....	308
33	Load Weighing Device.....	310
33.1	LWD Communication.....	310
34	Status.....	312
34.1	Input Status.....	312
34.2	Output Status.....	312
34.3	Valves 1, 2, 3 & 4 Statuses.....	313
34.4	Soft Starter and Soft Starter 2 Status.....	314
34.5	Expansion Status.....	315
34.6	Riser Board Status.....	316
34.7	CPLD.....	317
34.8	E-Power Status.....	321
34.9	EMS Status.....	323
34.10	Hall Call Status.....	323
34.11	Virtual Inputs.....	324

34.11.1	Remote Commands	324
34.12	DIP Status.....	329
34.13	Door Status	329
35	Group Setup	330
35.1	Group Car Index	330
35.2	Group Landing Offset	330
35.3	Dispatch Timeout	331
35.4	Dispatch Offline Timeout	332
36	XREG	333
36.1	XReg Cars.....	333
36.2	XReg Dest Timeout.....	333
36.3	XReg Dest Offline Timeout	334
36.4	XReg Destination	335
36.5	XReg Data.....	335
37	PI Labels.....	337
38	Attendant	338
38.1	Dispatch Timeout	338
38.2	Buzzer Time	338
39	Real-Time Clock.....	340
39.1	Clock Status	340
40	Debug	341
40.1	View Debug	341
40.2	Enter Car Calls	344
40.3	Enter Hall Calls.....	344
40.4	Enter Door Command	345
40.5	View Network Packet	345
40.6	View Group Packet	346
40.7	Acceptance Test.....	346
40.8	Emergency Bitmap	347
40.9	Module Statuses	347
40.9.1	Motion Status	347
40.9.2	Pattern Data	348
40.9.3	Auto Status.....	349
40.9.4	Recall Status	349
40.9.5	Fire Status	350

40.9.6	Counterweight Status.....	351
40.9.7	Floor Learn Status	351
40.10	Car Destination	352
40.11	Run Counter	353
40.12	DebugRuns.....	353
40.12.1	Dwell Time	353
40.12.2	Terminal to Terminal	354
40.12.3	Floor to Floor	355
40.12.4	Random.....	356
40.12.5	Hall Random Runs.....	357
41	About.....	359
42	Faults.....	360
42.1	Active Faults.....	360
42.2	Logged Faults	361
42.3	Cleared Faults.....	361
42.4	List of Faults	362
42.4.1	Brakes.....	362
42.4.2	CPLD	364
42.4.3	DIP Switches	369
42.4.4	Doors.....	370
42.4.5	Emergency Power.....	371
42.4.6	Expansion Boards.....	372
42.4.7	Fire.....	375
42.4.8	Floors	375
42.4.9	Hall Boards.....	375
42.4.10	Landing System	376
42.4.11	Miscellaneous	380
42.4.12	Motion Control	420
42.4.13	Parameters	423
42.4.14	Rescue Device.....	424
42.4.15	Digital S-curve Technology™ (U.S. Patent Pending).....	425
42.4.16	Safety	426

42.4.17	Speed	435
43	Alarms	440
43.1	Active Alarms	440
43.2	Logged Alarms.....	441
43.3	Cleared Alarms	441
43.4	List of Alarms	441
43.4.1	CPLD	441
43.4.2	Doors.....	442
43.4.3	Fire.....	443
43.4.4	Floors	444
43.4.5	Landing System	445
43.4.6	Load Weighing Device	447
43.4.7	Miscellaneous	448
43.4.8	Parameters	465
43.4.9	Riser Boards	466
43.4.10	Safety	470
43.4.11	Speed	478
	List of Abbreviations	479
	References.....	480

List of Figures

Figure 1: Hydro:Evolved Controller	2
Figure 2: COP Board	3
Figure 3: CT Board	3
Figure 4: Smart Positioning Landing System (left)	4
Figure 5: Smart Positioning Landing System (Right)	4
Figure 6: Ground Bus Terminal Blocks	5
Figure 7: MR Board - SR3032.....	8
Figure 8: Navigation Buttons.....	9
Figure 9: Example of Selected Menu	9
Figure 10: 24 VDC Connector.....	10
Figure 11: Reset Switches	10
Figure 12: NTS Connector	10
Figure 13: CN Connector.....	11
Figure 14: CAN 1,2,3 Network Connector.....	12
Figure 15: 120 VAC Connector	12
Figure 16: 24 VDC Input Connector.....	13
Figure 17: 24 VDC Output Connector.....	13
Figure 18: 24 VDC Monitoring System Connector	14
Figure 19: Safety String Input Connector	15
Figure 20: 120 VAC Input and Output Connector	16
Figure 21: Hall Lock Connector	17
Figure 22: MR Board SR3032 Inspection Control	18
Figure 23: MR Board SR3032 Safety Relays	19
Figure 24: SRU Board SR3030.....	20
Figure 25: I/O Board/Riser Board SR3031	22
Figure 26: 24 Input Board SR3041	23
Figure 27: 10 DIP Hall Board SR1060-E	25
Figure 28: 12 DIP Hall Board SR1060-G	25
Figure 29: Valve Board SR-3045 Gen 3.....	27
Figure 30: Status – Inputs, Outputs, and Expansion Status Menus	28
Figure 31: Status – Hall Call Status, CPLD Status, Virtual Inputs, and DIP Status Menus.....	30
Figure 32: Faults and Alarms Menu	31
Figure 33: Setup – Setup I/O, Safety, and Run Timers Menus.....	32
Figure 34: Setup - Door Setup Menu	35
Figure 35: Setup – Speeds, Floors, and Hoistway Access Menus	37
Figure 36: Setup –Fire, and Earthquake Menus	39
Figure 37: Setup – Miscellaneous Menu.....	42
Figure 38: Setup – Load Weigher and Group Setup Menus	45

Figure 39: Setup – Flood, EMS, Sabbath, Swing, and Attendant Menus	48
Figure 40: Setup – E-Power and Hydro Menus	50
Figure 41: Setup – Access Code Menu	53
Figure 42: Debug Menus	54
Figure 43: MAIN MENU - Status, Faults, Alarms	57
Figure 44: MAIN MENU – Setup, Debug, About	57
Figure 45: STATUS Menu – Inputs, Outputs, Valve 1 Status.....	57
Figure 46: STATUS Menu – Valve 2 Status, Valve 3 Status, Valve 4 Status.....	57
Figure 47: STATUS Menu – Soft Starter Status, Soft Starter 2 Status, Expansion Status	58
Figure 48: STATUS Menu – Riser Board Status, Hall Board Status, Hall Lantern Status	58
Figure 49: STATUS Menu – Hall Security Status	58
Figure 50: STATUS Menu – Hall Call Status, DAD Status, Clock.....	58
Figure 51: STATUS Menu – CPLD Status, Load Weigher Status, E-Power Status	58
Figure 52: STATUS Menu – EMS Status, Virtual Input, DIP Status.....	58
Figure 53: STATUS Menu – Door Status (F) and Door Status (R).....	59
Figure 54: FAULTS Menu – Active, Logged, Clear Log	59
Figure 55: ALARMS Menu – Active, Logged, Clear Log	59
Figure 56: SETUP MENU – Setup I/O, Safety, Run Timers.....	59
Figure 57: SETUP MENU – Door Setup, Speeds, Floors	59
Figure 58: SETUP MENU – Hoistway Access, Fire.....	60
Figure 59: SETUP MENU – Earthquake, Miscellaneous, PI Labels	60
Figure 60: SETUP MENU –Real-Time Clock, Load Weigher, Group Setup	60
Figure 61: SETUP MENU – Group Setup, Flood, EMS	60
Figure 62: SETUP MENU – Sabbath, Swing, Attendant.....	60
Figure 63: SETUP MENU – E-Power, Hydro, Access Code.....	60
Figure 64: DEBUG Menu – Enter Car Calls, Enter Hall Calls, Enter Door Command.....	61
Figure 65: DEBUG Menu – Edit Parameters, View Network Packet, View Group Packets	61
Figure 66: DEBUG Menu – View Debug Data, Acceptance Test, EmergencyBitmap	61
Figure 67: DEBUG Menu – Module Statuses, Car Data, Car Destinations.....	61
Figure 68: DEBUG Menu –Run Counter, DebugRuns.....	61
Figure 69: DEBUG Menu – XReg Destination, XReg Data, SH Dynamic Car Parking.....	62
Figure 70: DEBUG Menu – SH Predictive Car Parking SH Remote Commands and View Module Data	62
Figure 71: PARAMETER EDIT Menu – Hexadecimal or Decimal Format.....	63
Figure 72: EDIT AS BINARY Menu	63
Figure 73: EDIT AS HEXADECIMAL Menu.....	63
Figure 74: EDIT AS DECIMAL Menu	63
Figure 75: Breakers in the OFF Position	64
Figure 76: L1/L2 Breaker	64
Figure 77: Construction Mode Connections on HEV Controller	65
Figure 78: MR INSPECTION Switch.....	67
Figure 79: Car Run Box	67

Figure 80: SPEEDS Menu – Inspection Speed	68
Figure 81: INSPECTION SPEED Menu	68
Figure 82: TIMERS Menu.....	70
Figure 83: START TIMERS Menu	70
Figure 84: STOP TIMERS Menu	70
Figure 85: Coded Tape.....	71
Figure 86: Gloves Required.....	71
Figure 87: Tape Minimum Bend Radius	72
Figure 88: Routing Tape	72
Figure 89: Unistrut Installation	73
Figure 90: Sensor Array Assembly Positioning	74
Figure 91: Location of Tape Mount Assemblies	75
Figure 92: Upper Tape Unistrut Installation	76
Figure 93: Hardware	76
Figure 94: Gap Verification	77
Figure 95: Tape Clip Assembly	77
Figure 96: Tape Clip Insertion	78
Figure 97: Tape Clip Assembly Alignment	78
Figure 98: Optical Axis.....	79
Figure 99: Tape Clip Assembly Placement (Rear View).....	79
Figure 100: Tape Clip Assembly Alignment	80
Figure 101: Lower Tape Mount Assembly.....	81
Figure 102: Hardware to Lower Tape Mount Assembly	81
Figure 103: Sensor Array Assembly.....	82
Figure 104: Sensor Array Assembly (Right Side).....	83
Figure 105: Sensor Array Assembly (Left Side)	83
Figure 106: Dual Sensor Array Assembly	84
Figure 107: Dual Sensor Array Assembly (Right Side)	84
Figure 108: Dual Sensor Array Assembly (Left Side)	85
Figure 109: Emergency Tape Break Switch in Series with Buffer Switch	86
Figure 110: Unistrut to Lower Tape Mount Assembly	86
Figure 111: Emergency Tape Break Switch.....	87
Figure 112: Sensor Array Assembly Adjustment	87
Figure 113: RJ45 Connection.....	88
Figure 114: Optical Sensor LEDs.....	88
Figure 115: Alignment Arrows	89
Figure 116: Proximity Sensor Assembly	91
Figure 117: Mounting Proximity Sensor Assembly (Example)	91
Figure 118: Gloves Required	92
Figure 119: Magnetic Tape Installation	93
Figure 120: Check Status by Main Screen Method	95

Figure 121: Normal to Hold UP/DN To Start	95
Figure 122: Learn Complete	96
Figure 123: SPEEDS Menu – Contract Speed	97
Figure 124: CONTRACT SPEED Menu	97
Figure 125: SPEEDS Menu – Leveling Speed	98
Figure 126: LEVELING SPEED Menu	98
Figure 127: SPEEDS Menu – Test Buffer Speed	99
Figure 128: BUFFER SPEED Menu	99
Figure 129: FLOORS Menu – Number Of Floors	100
Figure 130: NUMBER Of FLOORS Menu	100
Figure 131: FLOORS Menu – Too High/Too Low	101
Figure 132: ADJUST FLOORS Menu – Too Low	101
Figure 133: ADJUST FLOORS Menu – Too High.....	102
Figure 134: FLOORS Menu – Security (Front or Rear).....	102
Figure 135: SECURITY FLOORS Menu	102
Figure 136: ACCESS CODE Menu – Access Codes (Front or Rear).....	103
Figure 137: ACCESS CODES FRONT Menu – Floor Number.....	103
Figure 138: ACCESS CODES REAR Menu – Floor Number	104
Figure 139: No Access Code	104
Figure 140: FRONT ACCESS CODE Menu.....	104
Figure 141: REAR ACCESS CODE Menu	104
Figure 142: Invalid Floor	104
Figure 143: ACCESS CODE Menu – Enable Front (or Rear) Doors	105
Figure 144: DISABLE FRONT DOORS Menu.....	105
Figure 145: ACCESS CODE Menu – Offset Floors.....	105
Figure 146: OFFSET FLOORS Menu	106
Figure 147: ACCESS CODE Menu – CCB Timer	106
Figure 148: CCB TIMER Menu	106
Figure 149: FLOORS Menu – Enable Releveling	107
Figure 150: ENABLE RELEVELING Menu	107
Figure 151: FLOORS Menu – Relevel Zone Size.....	108
Figure 152: RELEVEL ZONE SIZE Menu.....	108
Figure 153: FLOORS Menu – Releveling Delay	108
Figure 154: RELEVELING DELAY Menu	108
Figure 155: FLOOR Menu – Openings.....	109
Figure 156: FLOOR OPENING Menu	109
Figure 157: FLOORS Menu – Wander Guard	110
Figure 158: WANDER GUARD Menu	110
Figure 159: FLOORS Menu – Store Floor Level.....	110
Figure 160: STORE FLOORS Menu	110
Figure 161: FLOORS Menu – Short Floor Opening.....	111

Figure 162: SHORT FLOOR OPENING Menu.....	111
Figure 163: FLOOR Menu – Timed Car Call Security	112
Figure 164: TIMED CC SECURITY Menu – Enable Floor (Front or Rear)	112
Figure 165: TIMED CAR CALL SECURITY Menu – Start (M-F)	112
Figure 166: WEEKDAY START TIME Menu	112
Figure 167: TIMED CAR CALL SECURITY Menu – Stop (M-F).....	113
Figure 168: WEEKDAY STOP TIME Menu.....	113
Figure 169: TIMED CAR CALL SECURITY Menu – Start (S-S)	113
Figure 170: WEEKEND START TIME Menu.....	113
Figure 171: TIMED CAR CALL SECURITY Menu – Stop (S-S)	114
Figure 172: WEEKEND STOP TIME Menu	114
Figure 173: FLOOR Menu – Timed Hall Call Security	114
Figure 174: TIMED HALL CALL SECURITY Menu – Enable Floor (Front or Rear)	115
Figure 175: TIMED HALL CALL SECURITY Menu – Start (M-F).....	115
Figure 176: TIMED HALL CALL SECURITY Menu – Stop (M-F)	115
Figure 177: TIMED HALL CALL SECURITY Menu – Start (S-S)	116
Figure 178: TIMED HALL CALL SECURITY Menu – Stop (S-S).....	116
Figure 179: SETUP I/O Menu – Setup Inputs	117
Figure 180: SELECT BOARD Menu – Machine Room	117
Figure 181: Input Menu	118
Figure 182: SABBATH Menu – Key Enable Only.....	118
Figure 183: KEY ENABLE ONLY Menu	118
Figure 184: SABBATH Menu – Floors Opening (F)	119
Figure 185: FLOOR OPENINGS (Front) Menu.....	119
Figure 186: SABBATH Menu – Floors Opening (R)	119
Figure 187: FLOORS OPENINGS (Rear) Menu	119
Figure 188: SABBATH Menu – Destinations Up	120
Figure 189: UP DESTINATIONS Menu	120
Figure 190: SABBATH Menu – Destinations Down	120
Figure 191: DOWN DESTINATION Menu.....	120
Figure 192: SABBATH Menu – Timer Enable Only.....	121
Figure 193: TIMER ENABLE ONLY Menu	121
Figure 194: SABBATH Menu – Friday Start Time.....	121
Figure 195: FRIDAY START TIME Menu	122
Figure 196: SABBATH Menu – SATURDAY END Time	122
Figure 197: SATURDAY END TIME Menu	122
Figure 198: SABBATH Menu – Door Dwell Timer	122
Figure 199: DOOR DWELL TIMER Menu	123
Figure 200: SABBATH Menu – Key or Timer Enable	123
Figure 201: Key or Timer Enable Menu	123
Figure 202: DOORS Menu – Control Doors	124

Figure 203: CONTROL DOORS Menu.....	125
Figure 204: DOORS Menu –Door Dwell Timer	125
Figure 205: DOORS Menu – Hall Dwell Timer	125
Figure 206: HALL DWELL TIMER Menu	126
Figure 207: DOORS Menu – ADA Dwell Timer	126
Figure 208: ADA DWELL TIMER Menu.....	126
Figure 209: DOORS Menu – Hold Dwell Timer	127
Figure 210: HOLD DWELL TIMER Menu	127
Figure 211: DOORS Menu – Lobby Dwell Timer	127
Figure 212: LOBBY DWELL TIMER Menu.....	127
Figure 213: DOORS Menu – Door Stuck Timer	128
Figure 214: DOOR STUCK TIMER Menu	128
Figure 215: DOORS Menu – Door Nudge Timer	129
Figure 216: DOOR NUDGE TIMER Menu.....	129
Figure 217: DOORS Menu – Rear Doors	129
Figure 218: REAR DOORS Menu	130
Figure 219: DOORS Menu – PreOpening Distance	130
Figure 220: PREOPENING DISTANCE Menu	130
Figure 221: DOORS Menu – DC On Run	131
Figure 222: DC ON RUN Menu	131
Figure 223: DOORS Menu – DC On Close	131
Figure 224: DC ON DOOR CLOSE Menu	132
Figure 225: DOORS Menu – DO On Open	132
Figure 226: DO ON DOOR OPEN Menu	132
Figure 227: DOORS Menu – Disable On CT Stop.....	133
Figure 228: DISABLE ON CT STOP Menu	133
Figure 229: DOORS Menu – Disable On HA	133
Figure 230: DISABLE ON HA Menu.....	133
Figure 231: DOORS Menu – AT400 Doors	134
Figure 232: ENABLE AT400 DOOR Menu	134
Figure 233: DOORS Menu – No Demand Doors Open	134
Figure 234: NO DEMAND DOORS OPEN Menu	135
Figure 235: DOORS Menu – Jumper Timer	135
Figure 236: JUMPER TIMEOUT Menu	135
Figure 237: DOORS Menu – Jumper On DOL.....	136
Figure 238: LOCKS JUMPED ON DOL Menu	136
Figure 239: DOORS Menu – Hourly Fault Limit.....	136
Figure 240: DOOR HOURLY FAULT LIMIT Menu	137
Figure 241: DOORS Menu – Nudge – Buzzer Only.....	137
Figure 242: NUDGE – BUZZER ONLY Menu	137
Figure 243: DOORS Menu – Opening Time.....	138

Figure 244: OPENING TIME Menu	138
Figure 245: DOORS Menu – Check Time	138
Figure 246: CHECK TIME Menu	138
Figure 247: DOORS Menu – Door Type (Front or Rear)	139
Figure 248: DOOR TYPE Menu	139
Figure 249: DOORS Menu – Lock and CAM Timeout.....	140
Figure 250: TIMEOUT LOCK AND CAM Menu	140
Figure 251: DOORS Menu – Retiring CAM	140
Figure 252: RETIRING CAM Menu	140
Figure 253: DOORS Menu – Fixed CAM.....	141
Figure 254: FIXED CAM Menu	141
Figure 255: DOORS Menu – Swing Lock GSW Timeout.....	142
Figure 256: SWING LOCK GSW TIMEOUT Menu.....	142
Figure 257: DOORS Menu – Swing Contacts Timeout.....	142
Figure 258: SWING CONTACTS TIMEOUT Menu.....	142
Figure 259: DOORS Menu – Disable DOB Rear	143
Figure 260: DISABLE REAR DOB Menu	143
Figure 261: VIEW DEBUG DATA Menu – Front Door	143
Figure 262: VIEW DEBUG DATA Menu – Rear Door	145
Figure 263: Car Data Overview Status.....	146
Figure 264: Hall Mask Status	149
Figure 265: Front Opening Map Status	150
Figure 266: Rear Opening Map Status	150
Figure 267: Front Security Map Status	151
Figure 268: Rear Security Map Status	151
Figure 269: Linked Hall Mask Status.....	152
Figure 270: Front Hall Security Map Status	153
Figure 271: Rear Hall Security Map Status	153
Figure 272: Front and Rear Hall Security Mask Status	154
Figure 273: Dispatching Timers Status	155
Figure 274: VIP Flags Status	156
Figure 275: VIP Mask Status	157
Figure 276: Front Car Call Enable Bitmap Status	157
Figure 277: Rear Car Call Enable Bitmap Status Menu	158
Figure 278: Emergency Medical Call Mask and Landing	159
Figure 279: Standard CAN Bus	160
Figure 280: Hall Board Status	161
Figure 281: Uninitialized Hall Board Status	161
Figure 282: MISCELLANEOUS Menu – Enable Hall Security.....	162
Figure 283: ENABLE HALL SECURITY Menu	162
Figure 284: GROUP SETUP Menu – Hall Security Mask	163

Figure 285: HALL SECURITY MASK Menu	163
Figure 286: GROUP SETUP Menu – Hall Security Map (Front or Rear)	163
Figure 287: HALL SECURITY MAP FRONT Menu.....	164
Figure 288: HALL SECURITY MAP REAR Menu	164
Figure 289: GROUP SETUP Menu – Hall Call Mask	164
Figure 290: HALL CALL MASK Menu	165
Figure 291: GROUP SETUP Menu – Linked Hall Mask.....	166
Figure 292: LINKED HALL MASK 1 Menu	166
Figure 293: GROUP SETUP Menu – Hall Medical Mask.....	167
Figure 294: HALL MEDICAL MASK Menu	167
Figure 295: GROUP SETUP Menu – Hall Medical Rear Door Mask.....	167
Figure 296: HALL MEDICAL REAR DOOR MASK Menu	168
Figure 297: GROUP SETUP Menu – Hall Rear Door Mask	168
Figure 298: HALL REAR DOOR MASK Menu	168
Figure 299: Hall Lantern Status	170
Figure 300: Uninitialized Hall Lantern Status.....	171
Figure 301: HYDRO SETUP Menu – Valve Type Select	172
Figure 302: VALVE TYPE Menu	172
Figure 303: HYDRO SETUP Menu – Secondary Valve Board	173
Figure 304: SECONDARY VALVE BOARD Menu	173
Figure 305: HYDRO SETUP Menu – Third Valve Board.....	173
Figure 306: THIRD VALVE BOARD Menu	174
Figure 307: HYDRO SETUP Menu – Fourth Valve Board	174
Figure 308: FOURTH VALVE BOARD Menu	174
Figure 309: HYDRO SETUP – Soft Starter.....	175
Figure 310: SOFT STARTER Menu – Primary.....	175
Figure 311: PRIMARY Menu – Ramp Up Time.....	175
Figure 312: RAMP UP TIME Menu.....	176
Figure 313: PRIMARY Menu – Vmax	176
Figure 314: VMAX AC VOLTAGE Menu	176
Figure 315: PRIMARY Menu – Over Current.....	177
Figure 316: OVERCURRENT Menu	177
Figure 317: PRIMARY Menu – Over Temperature.....	177
Figure 318: OVERTEMPERATURE LIMIT Menu	178
Figure 319: SOFT STARTER Menu – Secondary.....	178
Figure 320: SECONDARY Menu – Enable Secondary.....	178
Figure 321: ENABLE SECONDARY SOFT STARTER Menu.....	179
Figure 322: SECONDARY Menu – Ramp Up Time	179
Figure 323: SECONDARY Menu – VMax.....	180
Figure 324: SECONDARY Menu – Over Current	180
Figure 325: SECONDARY Menu – Over Temperature	181

Figure 326: SOFT STARTER Menu – Third	181
Figure 327: THIRD Menu – Enable Third	181
Figure 328: ENABLE THIRD SOFT STARTER Menu	182
Figure 329: SOFT STARTER Menu – Run With One Soft Starter.....	182
Figure 330: Run With One Soft Starter Menu.....	182
Figure 331: Slowdown Distance.....	184
Figure 332: HYDRO SETUP Menu – Level Maximum Run Distance.....	185
Figure 333: LEVEL MAXIMUM RUN DISTANCE Menu	186
Figure 334: HYDRO SETUP Menu – NTS Buffer Distance Up or Down	186
Figure 335: NTS BUFFER DISTANCE UP Menu	186
Figure 336: NTS BUFFER DISTANCE DOWN Menu.....	186
Figure 337: HYDRO SETUP Menu – Destination Offset (Up or Down).....	187
Figure 338: DESTINATION OFFSET UP Menu.....	187
Figure 339: DESTINATION OFFSET Down Menu	188
Figure 340: HYDRO SETUP Menu – Relevel Offset (Up or Down)	188
Figure 341: RELEVEL OFFSET UP Menu.....	188
Figure 342: Relevel Offset Down Menu	189
Figure 343: HYDRO SETUP Menu – Speed Thresholds	189
Figure 344: SPEED THRESHOLD Menu.....	189
Figure 345: HYDRO SETUP Menu – Slowdown Distance UP or DOWN	190
Figure 346: SLOWDOWN DISTANCE UP Menu	190
Figure 347: SLOWDOWN DISTANCE DOWN Menu.....	190
Figure 348: HYDRO SETUP Menu – Hydro Speed Setup	191
Figure 349: Up Distance Menu	191
Figure 350: Down Distance Menu	191
Figure 351: GENERATE THRESHOLDS AND SLOWDOWNS? Menu	192
Figure 352: Down Distance Menu – Overshooting Adjustment.....	192
Figure 353: Up Distance Menu – Overshooting Adjustment.....	192
Figure 354: GENERATE THRESHOLDS AND SLOWDOWNS? Menu	193
Figure 355: Down Distance Menu – Steady State of Leveling Longer Adjustment.....	193
Figure 356: Up Distance Menu – Steady State of Leveling Longer Adjustment	193
Figure 357: GENERATE THRESHOLDS AND SLOWDOWNS? Menu	194
Figure 358: LEVELING TARGET Menu – Slowdown Target.....	194
Figure 359: ENABLE SLOWDOWN Menu – Slowdown Learn	194
Figure 360: Slowdown Target- Increase.....	195
Figure 361: Slowdown Target- Decrease.....	195
Figure 362: HYDRO SETUP-TSRD Distance	196
Figure 363: TSRD Distance.....	196
Figure 364: View Slowdown Distance Up.....	197
Figure 365:View Slowdown Distance Down.....	197
Figure 366: SLOWDOWN DISTANCE UP – Adjustment	198

Figure 367: SLOWDOWN DISTANCE DOWN – Adjustment	199
Figure 368: HYDRO SETUP Menu – TSRD Distance	199
Figure 369: TSRD Distance Menu	199
Figure 370: HYDRO SETUP Menu – Battery Test Time.....	200
Figure 371: Battery Test Time Menu	200
Figure 372: HYDRO SETUP Menu – Jack Resync.....	200
Figure 373: JACK RESYNC Menu – Jack Resync Time	201
Figure 374: JACK RESYNC TIME Menu	201
Figure 375: HYDRO SETUP Menu – Disable NTS Alarm	201
Figure 376: DISABLE NTS ALARM Menu	201
Figure 377:HYDRO SETUP Menu – Viscosity.....	202
Figure 378: VISCOSITY Menu – Run Time 1min.....	202
Figure 379: RUN TIME 1MIN Menu	202
Figure 380:HYDRO SETUP Menu – Viscosity.....	203
Figure 381: VISCOSITY Menu – Rest Time 1min.....	203
Figure 382: REST TIME 1MIN Menu	203
Figure 383:HYDRO SETUP Menu – Viscosity.....	203
Figure 384: VISCOSITY Menu – Cycles Allowed.....	204
Figure 385: CYCLES ALLOWED Menu.....	204
Figure 386: HYDRO SETUP Menu – Viscosity.....	205
Figure 387: VISCOSITY Menu – Allow Calls.....	205
Figure 388: ALLOW CALLS Menu	205
Figure 389: DAD STATUS Menu	206
Figure 390: Unused Input/Output.....	207
Figure 391: Category and Input.....	208
Figure 392: SETUP I/O Menu – Invert Inputs	224
Figure 393: Invert Inputs Menu	224
Figure 394: SETUP I/O Menu – Invert Outputs.....	225
Figure 395: Invert Outputs Menu	225
Figure 396: Sync In Progress.....	229
Figure 397: Sync Complete	229
Figure 398: HOISTWAY ACCESS – Allowed Distance Top.....	231
Figure 399: ALLOWED DISTANCE – TOP Menu.....	231
Figure 400: HOISTWAY ACCESS – Top Floor.....	231
Figure 401: TOP FLOOR Menu.....	232
Figure 402: HOISTWAY ACCESS – Top Opening.....	232
Figure 403: TOP OPENING Menu	232
Figure 404: HOISTWAY ACCESS – Allowed Distance Bottom.....	232
Figure 405: ALLOWED DISTANCE – BOTTOM Menu	233
Figure 406: HOISTWAY ACCESS – Bottom Floor.....	233
Figure 407: BOTTOM FLOOR Menu	233

Figure 408: HOISTWAY ACCESS – Bottom Opening	233
Figure 409: BOTTOM OPENING Menu.....	234
Figure 410: HOISTWAY ACCESS – Hoistway Access Slide Distance	234
Figure 411: Hoistway Access Slide Distance	234
Figure 412: Car Movement	238
Figure 413: Door Operation	239
Figure 414: MISCELLANEOUS Menu – Bypass Term Limits	240
Figure 415: BYPASS TERM LIMITS Menu	240
Figure 416: MISCELLANEOUS Menu – Enable Construction Box	241
Figure 417: ENABLE CONSTRUCTION BOX Menu.....	241
Figure 418: MISCELLANEOUS Menu – Max Run Time	241
Figure 419: MAXIMUM RUN TIME Menu.....	241
Figure 420: MISCELLANEOUS Menu – CT Insp. Req. IC.....	242
Figure 421: IC REQ FOR CT Menu	242
Figure 422: MISCELLANEOUS Menu – Disable IdleTrvArrow	242
Figure 423: DISABLE IDLE TRV ARROW Menu.....	243
Figure 424: MISCELLANEOUS Menu – Enable Latches CC	243
Figure 425: ENABLE LATCHES Car Call Menu	243
Figure 426: MISCELLANEOUS Menu – Car To Lobby Floor	244
Figure 427: CAR TO LOBBY FLOOR Menu	244
Figure 428: MISCELLANEOUS Menu – Parking	245
Figure 429: GUI PARKING Menu – GUI Parking.....	245
Figure 430: ENABLE GUI PARKING Menu	245
Figure 431: PARKING Menu – Parking Timer.....	245
Figure 432: PARKING TIMER Menu.....	246
Figure 433: PARKING Menu – Parking Floor.....	246
Figure 434: PARKING FLOOR Menu	246
Figure 435: PARKING Menu – Parking Door Open	247
Figure 436: PARKING DOOR OPEN Menu.....	247
Figure 437: MISCELLANEOUS Menu – OOS	248
Figure 438: OOS Menu – Disable OOS	248
Figure 439: DISABLE OOS Menu	248
Figure 440: OOS Menu – Hourly Fault Limit.....	248
Figure 441: HOURLY FAULT LIMIT Menu	249
Figure 442: OOS Menu – Maximum Starts Per Minute.....	249
Figure 443: MAXIMUM STARTS PER MINUTE Menu	249
Figure 444: OOS Menu – Disable PI OOS	250
Figure 445: DISABLE PI OOS Menu	250
Figure 446: MISCELLANEOUS Menu – Enable 3 Digit PI	250
Figure 447: ENABLE 3 DIGIT PI Menu.....	251
Figure 448: MISCELLANEOUS Menu – Payment Passcode	251

Figure 449: PAYMENT PASSCODE Menu	251
Figure 450: MISCELLANEOUS Menu – Lockout Passcode.....	252
Figure 451: LOCKOUT PASSCODE Menu	252
Figure 452: MISCELLANEOUS Menu – Dir. Counter Limit	252
Figure 453: ENTER ACCESS CODE Menu	253
Figure 454: DIR. COUNTER LIMIT Menu.....	253
Figure 455: MISCELLANEOUS Menu – Direct Change Delay	253
Figure 456: DIRECT CHANGE DELAY Menu	254
Figure 457: MISCELLANEOUS Menu – Default	254
Figure 458: DEFAULT Menu – Default Floors.....	254
Figure 459: DEFAULT FLOORS Menu	255
Figure 460: DEFAULTING PARAMS Menu.....	255
Figure 461: DEFAULTING PARAMS Menu – Parameters Defaulted	255
Figure 462: DEFAULT Menu – Default S-Curve.....	255
Figure 463: DEFAULT S-CURVE Menu.....	256
Figure 464: DEFAULT Menu – Default Run Timers.....	256
Figure 465: DEFAULT RUN TIMERS? Menu	256
Figure 466: DEFAULT Menu – Default I/O	257
Figure 467: DEFAULT I/O Menu	257
Figure 468: DEFAULT Menu – Default Other	258
Figure 469: DEFAULT Other Menu	258
Figure 470: DEFAULT Menu – Default Factory.....	258
Figure 471: DEFAULT FACTORY Menu	259
Figure 472: DEFAULT Menu – Default FRAM	259
Figure 473: DEFAULT FRAM Menu	259
Figure 474: Input Menu – Enable Swing.....	261
Figure 475: SWING Menu – Calls Enable Swing.....	262
Figure 476: CALLS ENABLE Menu.....	262
Figure 477: DOORS Menu – Swing Openings (Front or Rear)	262
Figure 478: SWING DOOR OPENINGS Menu.....	262
Figure 479: GROUP SETUP Menu – Swing Call Mask	263
Figure 480: HALL SWING MASK Menu	263
Figure 481: SWING Menu – Stay In Group	264
Figure 482: STAY IN GROUP Menu	264
Figure 483: SWING Menu – Idle Timer	264
Figure 484: IDLE TIMER Menu	264
Figure 485: MISCELLANEOUS Menu – Fan & Light Timer	266
Figure 486: FAN & LIGHT TIMER Menu.....	266
Figure 487: MISCELLANEOUS Menu – External Fan Timer	267
Figure 488: MR FAN TIMER Menu.....	267
Figure 489: MISCELLANEOUS Menu – Arrival Update Time	267

Figure 490: ARRIVAL UPDATE TIME Menu.....	267
Figure 491: SAFETY Menu - Speed Deviation	268
Figure 492: SPEED DEVIATION Menu – Timeout.....	268
Figure 493: TIMEOUT Menu.....	268
Figure 494: SAFETY Menu – Lock Clip.....	269
Figure 495: LOCK CLIP TIMER Menu.....	269
Figure 496: SAFETY Menu – General ODL.....	269
Figure 497: GENERAL ODL Menu.....	270
Figure 498: SAFETY Menu – NTS ODL.....	270
Figure 499: NTS ODL Menu.....	270
Figure 500: SAFETY Menu –TSRD ODL.....	271
Figure 501: TSRD ODL Menu.....	271
Figure 502: E–POWER Menu – Number Active Cars	274
Figure 503: Number Active Cars Menu.....	274
Figure 504: E–POWER Menu – Priority Car.....	275
Figure 505: PRIORITY CAR Menu	275
Figure 506: E-POWER Menu – Pretransfer Stall	276
Figure 507: PRETRANSFER STALL Menu.....	276
Figure 508: EARTHQUAKE Menu – Enable EQ.....	277
Figure 509: ENABLE EQ Menu.....	277
Figure 510: EARTHQUAKE Menu – Set CW POS	278
Figure 511: Save CW Position Menu.....	278
Figure 512: INPUTS BY FUNCTION Menu – Fire/Earthquake.....	279
Figure 513: FIRE/EARTHQUAKE Menu	279
Figure 514: FIRE SERVICE Menu – Main Recall.....	280
Figure 515: MAIN RECALL Menu – Floor	280
Figure 516: MAIN RECALL FLOOR Menu	280
Figure 517: MAIN RECALL Menu – Opening.....	280
Figure 518: MAIN RECALL DOOR Menu.....	281
Figure 519: FIRE SERVICE Menu – Alt Recall	281
Figure 520: ALT RECALL Menu – Floor	281
Figure 521: ALT RECALL FLOOR Menu.....	282
Figure 522: ALT RECALL Menu – Opening.....	282
Figure 523: ALT RECALL DOOR Menu.....	282
Figure 524: FIRE SERVICE Menu – Main Smoke Action.....	283
Figure 525: MAIN SMOKE ACTION Menu – Main or Alt	283
Figure 526: USE ALT FLOOR Menu	283
Figure 527: MAIN SMOKE ACTION Menu – Flash Fire Hat	284
Figure 528: FLASH FIRE HAT Menu	284
Figure 529: MAIN SMOKE ACTION Menu – Shunt Trip	284
Figure 530: SHUNT ON RECALL Menu.....	285

Figure 531: FIRE SERVICE Menu – Alt Smoke Action	285
Figure 532: ALT SMOKE ACTION Menu – Main or Alt.....	285
Figure 533: USE ALT FLOOR Menu	286
Figure 534: ALT SMOKE ACTION Menu – Flash Fire Hat.....	286
Figure 535: FLASH FIRE HAT Menu	286
Figure 536: ALT SMOKE ACTION Menu – Shunt Trip.....	287
Figure 537: SHUNT ON RECALL Menu.....	287
Figure 538: FIRE SERVICE Menu – Hoistway Smoke Action.....	288
Figure 539: HOISTWAY SMOKE ACTION Menu – Main or Alt	288
Figure 540: USE ALT FLOOR Menu	288
Figure 541: HOISTWAY SMOKE ACTION Menu – Flash Fire Hat	289
Figure 542: FLASH FIRE HAT Menu	289
Figure 543: HOISTWAY SMOKE ACTION Menu – Shunt Trip	289
Figure 544: SHUNT ON RECALL Menu.....	290
Figure 545: FIRE SERVICE Menu – MR Smoke Action	290
Figure 546: MR SMOKE ACTION Menu – Main or Alt.....	290
Figure 547: USE ALT FLOOR Menu	291
Figure 548: MR SMOKE ACTION Menu – Flash Fire Hat	291
Figure 549: FLASH FIRE HAT Menu	291
Figure 550: MR SMOKE ACTION Menu – Shunt Trip	292
Figure 551: SHUNT ON RECALL Menu.....	292
Figure 552: FIRE SERVICE Menu – Recall Key	292
Figure 553: RECALL KEY Menu – Flash Fire Hat	293
Figure 554: FLASH FIRE HAT Menu	293
Figure 555: FIRE SERVICE Menu – PIT Smoke.....	293
Figure 556: PIT SMOKE Menu – Main or Alt	294
Figure 557: USE ALT FLOOR Menu	294
Figure 558: PIT SMOKE Menu – Flash Fire Hat	294
Figure 559: FLASH FIRE HAT Menu	295
Figure 560: PIT SMOKE Menu – Shunt Trip	295
Figure 561: SHUNT ON RECALL Menu.....	295
Figure 562: FIRE SERVICE Menu – Alt. Machine Room	296
Figure 563: ALT MACHINE ROOM Menu – Enable Alt. MR	296
Figure 564: ENABLE ALT MR Menu.....	296
Figure 565: ALT MACHINE ROOM Menu – HW 2 Smoke	297
Figure 566: HOISTWAY 2 SMOKE Menu – Main or Alt	297
Figure 567: USE ALT FLOOR Menu	297
Figure 568: HOISTWAY 2 SMOKE Menu – Flash Fire Hat	298
Figure 569: HOISTWAY 2 SMOKE Menu – Shunt Trip	298
Figure 570: SHUNT ON RECALL Menu.....	298
Figure 571: ALT MACHINE ROOM Menu – MR 2 Smoke.....	299

Figure 572: MR 2 SMOKE Menu – Main or Alt	299
Figure 573: MR 2 SMOKE Menu – Flash Fire Hat	300
Figure 574: MR 2 SMOKE Menu – Shunt Trip	300
Figure 575: FIRE SERVICE Menu – Advance Configurations	302
Figure 576: SMOKE CONFIGURATION Menu.....	302
Figure 577: FLOOD Menu – Number of Floors.....	303
Figure 578: NUMBER OF FLOOD FLOORS MENU	303
Figure 579: FLOOD Menu – Okay To Run.....	304
Figure 580: OKAY TO RUN Menu	304
Figure 581: FLOOD Menu – Override Fire	304
Figure 582: OVERRIDE FIRE Menu	304
Figure 583: EMS Menu – AllowPh2WithoutPh1	305
Figure 584: PH2 WITHOUT PH1 Menu	305
Figure 585: EMS Menu – Exit Ph2 Any Floor	306
Figure 586: EXIT PH2 ANY FLOOR Menu.....	306
Figure 587: EMS Menu – Fire Overrides Ph1	306
Figure 588: FIRE OVERRIDES PH1 Menu	307
Figure 589: EMS Menu – Ph1 Exit Delay	307
Figure 590: PH1 EXIT DELAY Menu	307
Figure 591: EMS Menu – Ph2 Exit Delay	308
Figure 592: PH2 EXIT DELAY Menu	308
Figure 593: EMS Menu – Ph1 Recall Floor	308
Figure 594: PH1 RECALL FLOOR Menu.....	309
Figure 595: LOAD WEIGHER SETUP Menu – Type Select	310
Figure 596: LOAD WEIGHER TYPE Menu – DISCRETE.....	310
Figure 597: LOAD WEIGHER TYPE Menu – SERIAL MR.....	310
Figure 598: LOAD WEIGHER TYPE Menu – SERIAL CT.....	311
Figure 599: INPUTS BY FUNCTION Menu –Inspection	312
Figure 600: INSPECTION Menu	312
Figure 601: OUPUS BY FUNCTION Menu –Controller	313
Figure 602: CONTROLLER Menu.....	313
Figure 603: Valve Status Menu – Part 1 of 3.....	313
Figure 604: Valve Status Menu – Part 2 of 3.....	313
Figure 605: Valve Status Menu – Part 3 of 3.....	314
Figure 606: Soft Starter Status Menu – Part 1 of 3	314
Figure 607: Soft Starter Status Menu – Part 2 of 3	314
Figure 608: Soft Starter Status Menu – Part 3 of 3	315
Figure 609: EXPANSION STATUS Menu – Expansion Group.....	315
Figure 610: Active Expansion Board Status	316
Figure 611: Inactive Expansion Board Status	316
Figure 612: Active Riser Board Status	316

Figure 613: Inactive Riser Board Status.....	317
Figure 614: CPLD STATUS Menu – MR, CT, COP CPLD	317
Figure 615: MR CPLD Menu.....	318
Figure 616: MR CPLD Menu Continued.....	318
Figure 617: CT CPLD Menu	318
Figure 618: CT CPLD Menu Continued.....	318
Figure 619: COP CPLD Menu	318
Figure 620: COP CPLD Menu Continued.....	319
Figure 621: E-POWER COMMAND Menu.....	322
Figure 622: E-POWER COMMAND Menu Continued	322
Figure 623: EMS STATUS Menu – Car 1 Assigned.....	323
Figure 624: EMS STATUS Menu – No Cars Assigned	323
Figure 625: HALL CALL STATUS Menu –Up or Down Calls.....	323
Figure 626:UP CALLS Menu	324
Figure 627: DOWN CALLS Menu.....	324
Figure 628: REMOTE COMMANDS Menu – Car Call Security	325
Figure 629: SECURE CAR CALLS Menu – Front or Rear	325
Figure 630: Secure Car Front Menu	325
Figure 631: Secure Car Rear Menu	325
Figure 632: REMOTE COMMANDS Menu – Hall Call Security.....	326
Figure 633: SECURE HALL CALLS Menu – Front or Rear	326
Figure 634: Secure Front Hall Call Menu	326
Figure 635: Secure Rear Hall Call Menu	326
Figure 636: REMOTE COMMANDS Menu – Virtual Inputs	327
Figure 637: Virtual Input Menu.....	327
Figure 638: REMOTE COMMANDS Menu – Recall Input	328
Figure 639: Recall Floor/Door Menu.....	328
Figure 640: REMOTE COMMANDS Menu – Door Command Landing.....	328
Figure 641: Door Command Landing Menu.....	328
Figure 642: DIP STATUS Menu – MR, CT, or COP DIP	329
Figure 643: DIP SWITCHES Menu	329
Figure 644: Door Status Menu	329
Figure 645: GROUP SETUP Menu – Group Car Index	330
Figure 646: GROUP CAR INDEX Menu	330
Figure 647: GROUP SETUP Menu – Group Landing Offset	331
Figure 648: GROUP LANDING OFFSET Menu	331
Figure 649: GROUP SETUP Menu – Dispatch Timeout.....	331
Figure 650: DISPATCHING TIMEOUT Menu.....	332
Figure 651: GROUP SETUP Menu – Dispatch Offline Timeout	332
Figure 652: DISPATCHING OFFLINE Menu	332
Figure 653: GROUP SETUP Menu – XREG Cars.....	333

Figure 654: NUM XREG CARS Menu	333
Figure 655: GROUP SETUP Menu – XReg Destination Timeout.....	334
Figure 656: XREG DESTINATION TIMEOUT Menu	334
Figure 657: GROUP SETUP Menu – XReg Destination Offline Timeout	334
Figure 658: XREG DESTINATION OFFLINE TIMEOUT Menu.....	335
Figure 659: DESTINATION Menu	335
Figure 660: Emergency Power Status Menu	336
Figure 661: Fire Emergency Power Status Menu	336
Figure 662: SET PI LABEL Menu	337
Figure 663: ATTENDANT Menu – Dispatch Timeout.....	338
Figure 664: DISPATCH TIMEOUT Menu	338
Figure 665: ATTENDANT Menu – Buzzer Time.....	339
Figure 666: BUZZER TIME Menu.....	339
Figure 667: Real-Time Clock Menu.....	340
Figure 668: Clock Menu.....	340
Figure 669: View Debug Data Menu	341
Figure 670: ENTER CAR CALLS Menu – Front or Rear.....	344
Figure 671: ENTER CAR CALL Menu	344
Figure 672: Hall Call Menu	344
Figure 673: Enter Door Command Menu (Front and Rear Doors).....	345
Figure 674: Enter Door Command Menu (Front Doors Only)	345
Figure 675: Network Packet	346
Figure 676: Group Packet	346
Figure 677: SELECT ACCEPTANCE TEST Menu	347
Figure 678: EMERGENCY STATUS Menu	347
Figure 679: MODULE STATUS Menu – Motion Status.....	347
Figure 680: Motion Status Menu Part 1 of 2.....	348
Figure 681: Motion Status Menu Part 1 of 2.....	348
Figure 682: Module Status Menu – Pattern Data	348
Figure 683: PATTERN DATA Menu Part 1 of 2	348
Figure 684: PATTERN DATA Menu Part 2 of 2	349
Figure 685: MODULE STATUS Menu – Auto Status	349
Figure 686: Auto Operation Status Menu.....	349
Figure 687: MODULE STATUS Menu – Recall Status.....	350
Figure 688: Recall Status Menu.....	350
Figure 689: MODULE STATUS Menu – Fire Status	350
Figure 690: Fire Status Menu	351
Figure 691: MODULE STATUS Menu – Counterweight Status	351
Figure 692: Counterweight Status Menu	351
Figure 693: MODULE STATUS Menu – Floor Learn Status.....	352
Figure 694: Floor Learn Status Menu.....	352

Figure 695: DESTINATION Menu	352
Figure 696: RUN COUNTER Menu	353
Figure 697: DEBUGRUNS Menu – Dwell Time	354
Figure 698: RUN DWELL TIME Menu.....	354
Figure 699: DEBUGRUNS Menu – Terminal To Terminal.....	354
Figure 700: TERMINAL TO TERMINAL Menu – Front or Rear	354
Figure 701: TERMINAL TO TERMINAL Menu	355
Figure 702: DEBUGRUNS Menu – Floor To Floor.....	355
Figure 703: FLOOR TO FLOOR Menu – Front or Rear	355
Figure 704: FLOOR 2 FLOOR (F) Menu.....	356
Figure 705: FLOOR 2 FLOOR (R) Menu	356
Figure 706: DEBUGRUNS Menu – Random.....	356
Figure 707: RANDOM Menu – Front or Rear	356
Figure 708: RANDOM RUNS (F) Menu	357
Figure 709: RANDOM RUNS (R) Menu	357
Figure 710: DEBUGRUNS Menu – Hall Random Runs	357
Figure 711: HALL RANDOM RUNS Menu	358
Figure 712: JOB ID	359
Figure 713: Active Faults Menu	360
Figure 714: Fault Part 1 of 3.....	360
Figure 715: Fault Part 2 of 3.....	360
Figure 716: Fault Part 3 of 3.....	361
Figure 717: FAULT LOG Menu.....	361
Figure 718: CLEAR FAULT LOG Menu	361
Figure 719: Active Alarms Menu.....	440
Figure 720: Alarm Part 1 of 2	440
Figure 721: Alarm Part 2 of 2	440
Figure 722: ALARM LOG Menu	441
Figure 723: CLEAR ALARM LOG Menu.....	441

List of Tables

Table 1: MR Board SR3032 Bank A DIP Switch Setting Configuration	6
Table 2: MR Board SR3032 Bank B DIP Switch Setting Configuration	6
Table 3: Navigation Buttons' Description.....	9
Table 4: CT/COP Board SR3030 Bank A DIP Switch Setting Configuration	20
Table 5: CT/COP Board SR3030 Bank B DIP Switch Setting Configuration	21
Table 6: I/O Board SR3031 DIP Switch Settings	22
Table 7: 24 Input Board SR3041 DIP Switch Settings	24
Table 8: 24 Input Board SR3041 DIP Switch Settings When SR3041 is Master.....	24
Table 9: 24 Input Board SR3041 DIP Switch Settings When SR3031 is Master.....	24
Table 10: Hall Board 10 DIP Switch Settings	25
Table 11: Hall Board 12 DIP Switch Settings	26
Table 12: Valve Select	27
Table 13: Status – Inputs, Outputs, and Expansion Status Menu Structures.....	28
Table 14: Status – Hall Call Status, CPLD Status, Virtual Inputs, and DIP Status Menu Structures	30
Table 15: Faults and Alarms Menu Structures.....	31
Table 16: Setup – Setup I/O, Safety, and Run Timers Menu Structures	32
Table 17: Setup – Door Setup Menu Structure	35
Table 18: Setup – Speeds, Floors and Hoistway Access Menu Structures	37
Table 19: Setup –Hoistway Access, Fire, and Earthquake Menu Structures	39
Table 20: Setup – Miscellaneous Menu Structures	42
Table 21: Setup – Load Weigher and Group Setup Menu Structures.....	45
Table 22: Setup – Flood, EMS, Sabbath, Swing, and Attendant Menu Structures	48
Table 23: Setup – E-Power and Hydro Menu Structures.....	51
Table 24: Setup – Access Code Menu Structures	53
Table 25: Debug and About Menu Structures	54
Table 26: Door Symbols for Each State	124
Table 27: Door Command Issued to the Door Module	144
Table 28: Car Status Codes	147
Table 29: Hall Mask Status Definitions	149
Table 30: Hall Board 10 DIP Hall Mask Mapping Switch Settings	165
Table 31: Hall board 12 DIP Hall Mask Mapping Switch Settings	165
Table 32: Description of Auto Operation Inputs.....	208
Table 33: Description of Car Call (Front and Rear) Inputs	210
Table 34: Description of Car Call Enable (Front and Rear) Inputs	210
Table 35: Description of Controller Inputs.....	211
Table 36: Description of Front Doors Inputs	212
Table 37: Description of Rear Doors Inputs	213
Table 38: Description of Emergency Power Inputs	214

Table 39: Description of Fire/Earthquake Inputs	215
Table 40: Description of Inspection Inputs	216
Table 41: Description of Safety Inputs	216
Table 42: Description of Auto Operation Outputs.....	217
Table 43: Description of Car Call (Front and Rear) Outputs	219
Table 44: Description of Controller Outputs.....	219
Table 45: Description of Front Doors Outputs	221
Table 46: Description of Rear Doors Outputs	222
Table 47: Description of Emergency Power Outputs	222
Table 48: Description of Fire/Earthquake Outputs	223
Table 49: Description of Inspection Output.....	223
Table 50: Description of Safety Outputs	224
Table 51: Inputs Used by the Controller for Emergency Power.....	272
Table 52: CPLD Menu Description.....	319
Table 53: CPLD Preflight Status.....	319
Table 54: CPLD Preflight Command	319
Table 55: CPLD Inputs	320
Table 56: Data Index for MR, CT, and COP Board Communication.....	341
Table 57: Faults Reported by Software or Hardware	362
Table 58: List of Faults related to Brakes	362
Table 59: List of Faults related to CPLD	364
Table 60: List of Faults related to DIP Switches	369
Table 61: List of Faults related to Doors	370
Table 62: List of Faults related to Emergency Power	371
Table 63: List of Faults related to Expansion Boards	372
Table 64: List of Faults related to Fire	375
Table 65: List of Faults relate to Floors.....	375
Table 66: List of Faults related to Hall Boards	375
Table 67: List of Faults related to Landing System	376
Table 68: List of Faults under Miscellaneous	380
Table 69: List of Faults related to Motion Control.....	420
Table 70: List of Faults related to Parameters	424
Table 71: List of Faults related to Rescue Device	424
Table 72: List of Faults related to Digital S-curve Technology™ (U.S. Patent Pending)	425
Table 73: List of Faults related to Safety.....	426
Table 74: List of Faults related to Speed.....	435
Table 75: List of Alarms related to CPLD.....	441
Table 76: List of Alarms related to Doors	442
Table 77: List of Alarms related to Fire	443
Table 78: List of Alarms related to Floors	444
Table 79: List of Alarms related to Landing System.....	445

Table 80: List of Alarms related to Load Weighing Device	447
Table 81: List of Alarms under Miscellaneous	448
Table 82: List of Alarms related to Parameters	466
Table 83: List of Alarms related to Riser Boards	466
Table 84: List of Alarms related to Safety	470
Table 85: List of Alarms related to Speed	478

Page intentionally left blank.

1 Hydro:Evolved Controller

The Hydro:Evolved controller is used on buildings that have up to ten landings and runs at 200 fpm.

The Hydro:Evolved Controller is built to learn and adapt.

1.1 List of Hydro:Evolved Manuals

The following is a list of Hydro:Evolved manuals included with the Hydro:Evolved package:

Hydro:Evolved User Manual: a detailed description of the Hydro:Evolved Controller including step by step procedures on how to configure the system.

Hydro:Evolved Testing Procedures: step by step procedure on how to test the Hydro:Evolved Controller.

Hydro:Evolved Soft Starter Startup: describes how to setup various soft starters that may be used within the Hydro:Evolved Controller. The following is a list of soft starters that can be used on the controller:

- Siemens
- Sprecher + Schuh

Hydro:Evolved GUI Manual: an in-depth description of how to use the Graphical User Interface to configure the controller.

Hydro:Evolved Parameter List: a detailed list of values that define the set conditions for the controller. The parameters are job configurable.

Quickstart Smart Battery Lowering Device: describes functionality, wiring, and maintenance.

Replacing Boards: consists of instructions on how to replace boards.

1.2 Hydro:Evolved Controller Components

The Hydro:Evolved Controller consists of the following:

1. **Hydro:Evolved Controller:** exchanges serial data between the Machine Room (MR), the Car Top (CT), and the Car Operating Panel (COP).

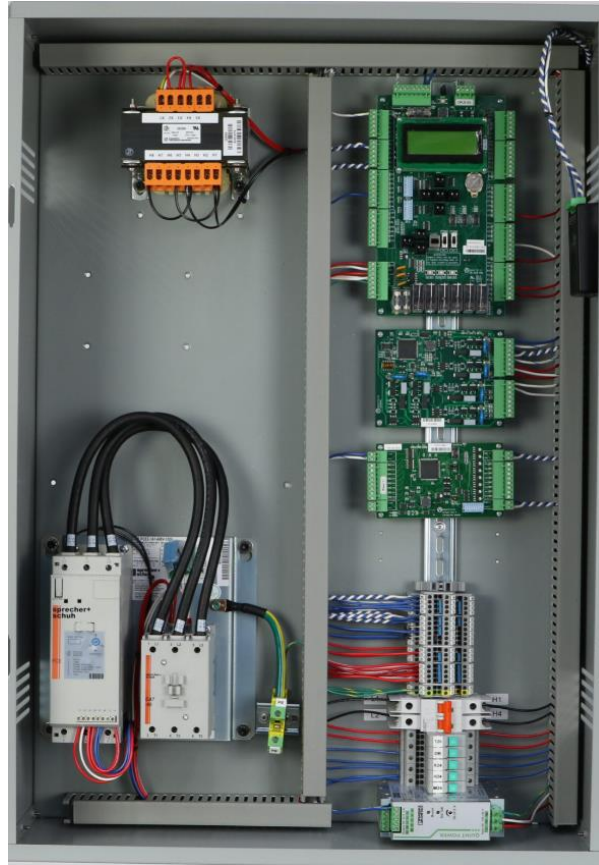

Figure 1: Hydro:Evolved Controller

2. **COP:** gathers localized inputs and outputs and connects them to the CT Controller.

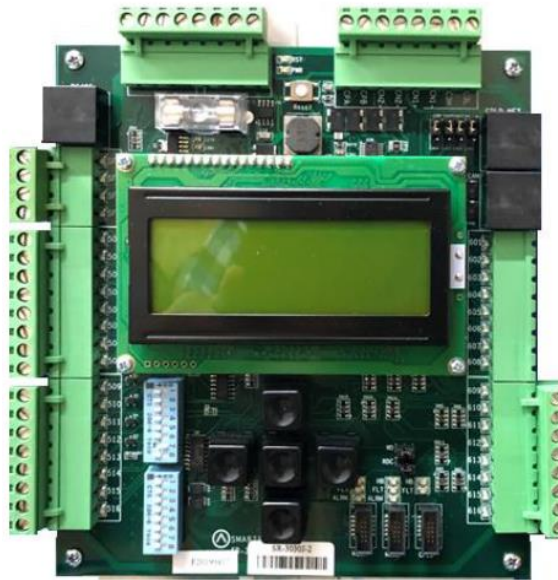

Figure 2: COP Board

3. **CT:** connects the components on the top of the car to the MR through the traveler cables. The CT manages part of the safety logic.



Figure 3: CT Board

4. **Smart Positioning Landing System:** tracks elevator speed and position with high precision and reliability. The sensor array assembly can be mounted on the left or on the right side.

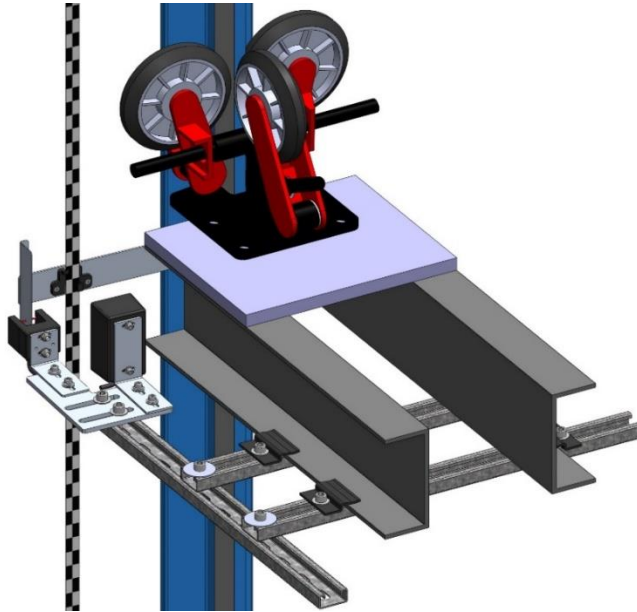

Figure 4: Smart Positioning Landing System (left)

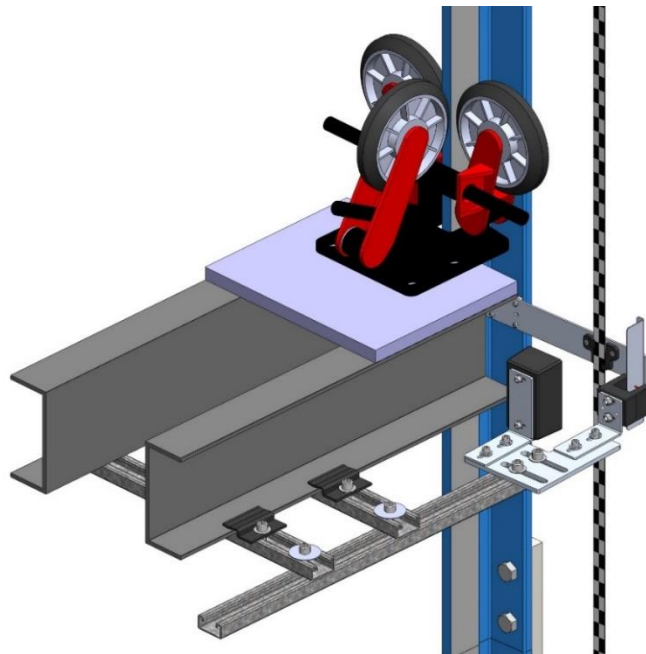

Figure 5: Smart Positioning Landing System (Right)

1.3 Safety

A proper and effective ground connection is required for the safe and successful operation of the controller. Ensure that each elevator controller disconnect has a sufficient earth ground provided from the building and runs to the earth ground inside the elevator controller (PE).

NOTE: the size of the ground wire should be the same size (AWG) as the ground lug wire internal inside the controller.

The system has one or more common ground bus terminal blocks (PE).



Figure 6: Ground Bus Terminal Blocks

The building, motor, transformer, and filter(s) must all share a common ground. Improper grounding can cause many types of issues with modern elevator control systems.

Proper grounding removes ground loops, limits impedance, and transfers noise into the ground.

1.4 Default Voltage Settings Prior to Installation

While Smartrise takes every measure to provide customers with an out-of-box installation, sometimes, incomplete information resorts to the application of default settings. This is done to protect the equipment from high voltage issues. For example, the door operator for a specific job might operate at 240 VAC but if Smartrise was not provided with that information when the job was engineered, the DR breaker (door operator voltage supply) is set to 120 VAC for safety reasons.

Prior to powering on the controller, verify that the voltages set by Smartrise (by referring to the electrical drawings provided) meets the voltages required for the existing equipment.

2 Controller Hardware

The controller consists of the following boards:

- MR board - SR3032
- Smartrise Universal (SRU) board - SR3030
- I/O board (Riser board) - SR 3031
- Hall board - SR1060
- Valve board - SR3045

2.1 MR Board SR3032

The MR board is the main interface on the controller.

There are two sets of DIP switch settings on the MR board - Bank A (upper bank) and Bank B (lower bank). Each setting is configured for a different functionality. Table 1 lists the functionality and description for each DIP switch located on Bank A.

Table 1: MR Board SR3032 Bank A DIP Switch Setting Configuration

DIP Switch	Functionality	Description
DIP 1	CPU Stop Switch	Halts parameters updates and used to reset some latched faults.
DIP 2	N/A	N/A
DIP 3	Capture Car/Disable Doors	Takes the car out of the group and completes all Car Calls before going into captured mode.
DIP 4	Enable GUI Edit (v1.02.54 and above)	Allows to Edit the parameters from GUI (including the restore param process).
DIP 5	Learn Mode	Activates Learn Mode on the controller to learn the hoistway.
DIP 6	Enable Tune	Sends message to the drive to begin the tune process. Used after setting the drive-in motor tune or encoder learn.
DIP 7	Pop-up Blocker	Disables the fault pop-up messages. Faults can still be viewed in the active and logged faults.
DIP 8	Bootloader Flag	Sets all boards in software download mode to update the firmware

Table 2 lists the functionality and description for each DIP switch located on Bank B.

Table 2: MR Board SR3032 Bank B DIP Switch Setting Configuration

DIP Switch	Functionality	Description
DIP 1	Invert NTS Output	When set to ON, NTS output is Active Low.
DIP 2	Rear Doors	Must be set if rear doors are present.
DIP 3	Enable Landing Insp	Must be set if landing inspection operation is used.
DIP 4	Enable Pit Insp	Must be set if Pit inspection operation is used.

DIP Switch	Functionality	Description
DIP 5	Sync Params	Writes parameters from cartop to machine room. This switch is used when replacing the MR board.
DIP 6	Bypass Fire Srv (w/ 01-0131)	Setting this along with parameter 01-0131 to ON bypasses fire service.
DIP 7	Preflight Check	It ensures the safety and proper functioning of the elevator. It involves checking mechanical, electrical, and safety components.
DIP 8	Unintended Movement Acceptance Test	Used during the unintended movement acceptance test.

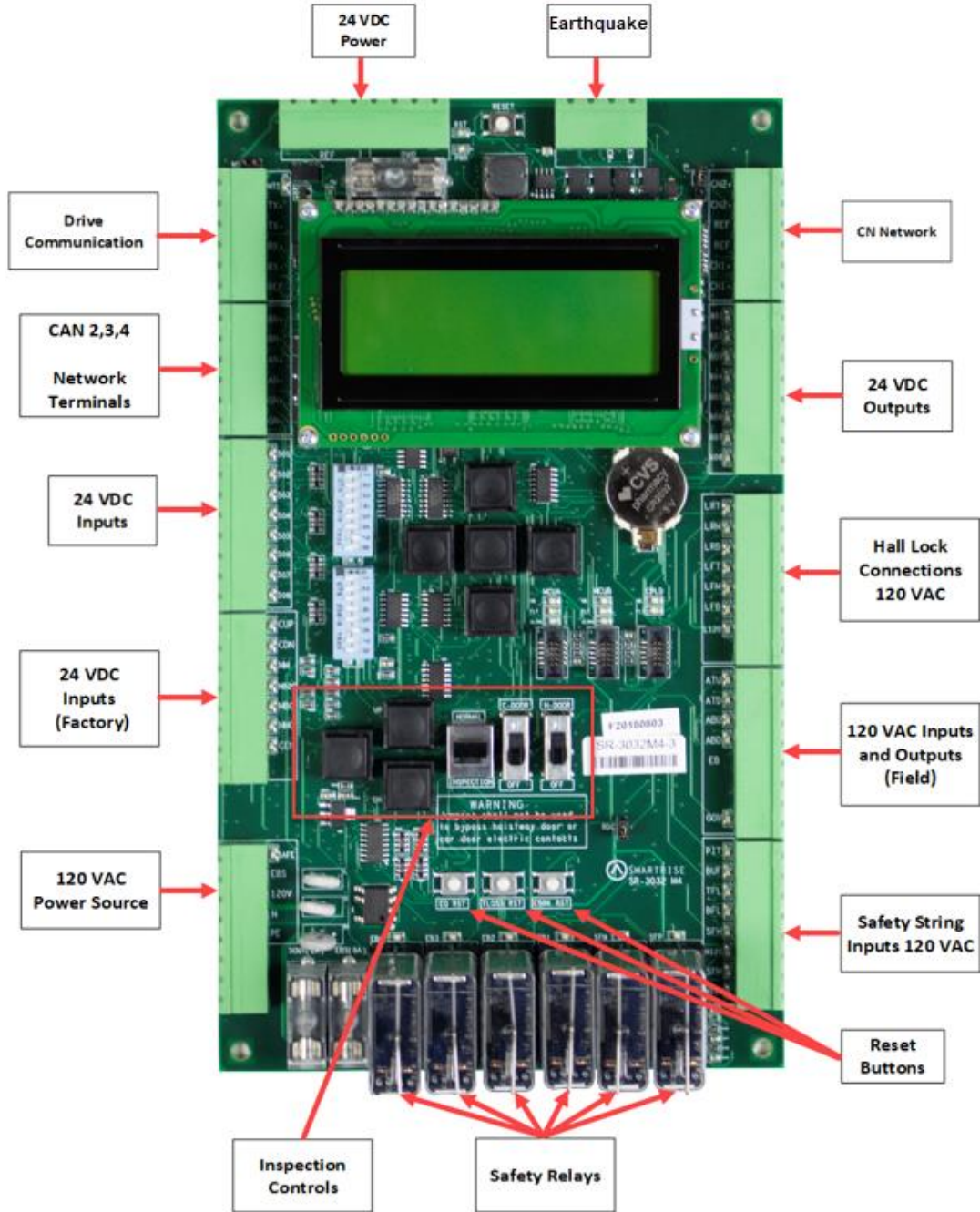

Figure 7: MR Board - SR3032

2.1.1 Navigation Buttons

The navigation buttons are the same on every SRU board.

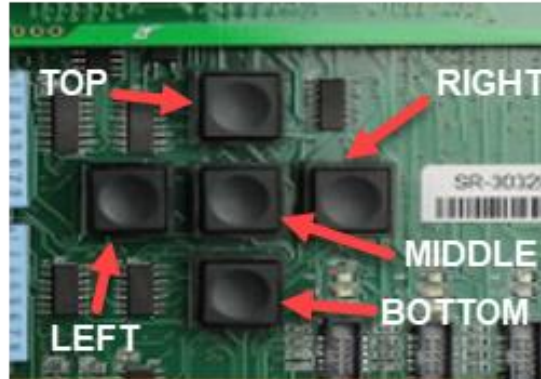

Figure 8: Navigation Buttons

The navigation buttons' descriptions are listed in Table 3.

Table 3: Navigation Buttons' Description

Button	Description
Top	Scrolls up through selected menu
Bottom	Scrolls down through selected menu
Left	Navigates back to Main Menu
Right	Navigates right through series of menus/submenus
Middle	Selects menu

A selected menu within a menu list is indicated with an asterisk (*) as shown in the figure below.

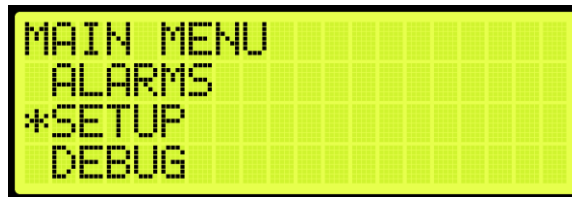

Figure 9: Example of Selected Menu

2.1.2 24 VDC Power Source

The 24 VDC Power and Reference connections to the ground require only one terminal connected to the MR board. All other connections can be used for auxiliary sources, as needed.

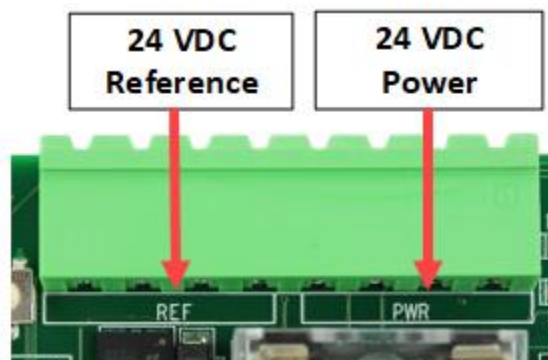

Figure 10: 24 VDC Connector

2.1.3 Reset Buttons

There are three reset buttons.

When performing a reset via the reset buttons, push the button and immediately release it - the fault will reset after 5-6 seconds.

- **EQ RST:** resets a seismic fault due to an earthquake.
- **TLOSS RST:** resets traction loss fault.
- **EBRK RST:** clears the latching type of fault.



Figure 11: Reset Switches

2.1.4 Normal Terminal Stop

The NTS connector triggers the Normal Terminal Stop (NTS) operation.

NTS Terminal: NTS output from MR board to Valve board to control the operation of the high UH/DH valves. If NTS is active, the valves are cutoff and the car goes from high speed to leveling speed.

See *Hydro:Evolved Controller sheet 5 MR Board* for wiring information.



Figure 12: NTS Connector

2.1.5 Network

The network is used for board-to-board communication between the Machine Room, Car Top, Car Operating Panel, and Expansion boards.

- **CN Network Terminals:** uses both CN1 and CN2 for communication.
- **REF Terminal:** provides a ground to prevent noise on the CN1 and CN2 signals.

These connections must be made before going into inspection or normal operation.

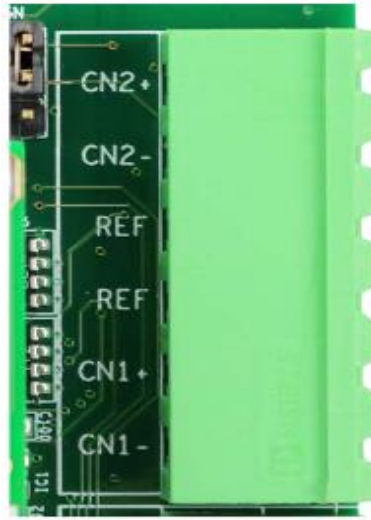

Figure 13: CN Connector

- **Valve Network (BN) Terminals:** communication between the Machine Room and Valve board.
- **Aux Network (AN) Terminals:** auxiliary communication between the Machine Room and any compatible third-party devices; for example, IE CE Drive board.

- **Group Network (GN) Terminals:** group communication – connects all the cars together in a group setting.



Figure 14: CAN 1,2,3 Network Connector

2.1.6 120 VAC Inputs and Outputs (Factory)

WARNING

ALL CONNECTIONS ON THIS TERMINAL BLOCK ARE HIGH VOLTAGE - DISCONNECT POWER TO THE CONTROLLER BEFORE WIRING THESE TERMINALS.

- **Safe Terminal:** SAFE output from MR board to Valve board to activate the UH/DH valves. See Hydro:Evolved Controller sheet 5 MR Board for wiring information.
- **EBS Terminal:** input neutral voltage from main line.



Figure 15: 120 VAC Connector

2.1.7 24 VDC Inputs and Outputs

The 24 VDC inputs are labeled 501- 508.

Each input is activated by connecting the 24 VDC to it. LEDs 501 - 508 are lit when active.

See the *Hydro:Evolved Controller sheet 5 MR Board* for wiring information.

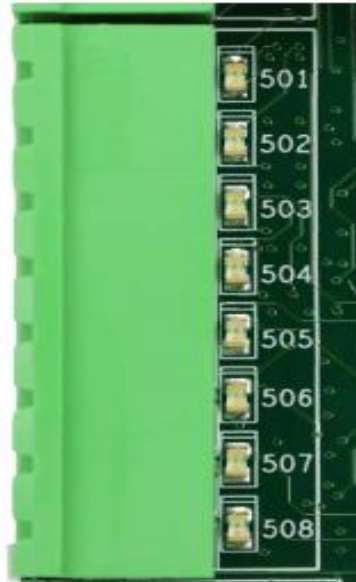

Figure 16: 24 VDC Input Connector

24 VDC outputs are labeled 601- 608.

Each output sinks to REF when activated. LEDs 601-608 are lit when active.

See the *Hydro:Evolved Controller sheet 5 MR Board* for wiring information.

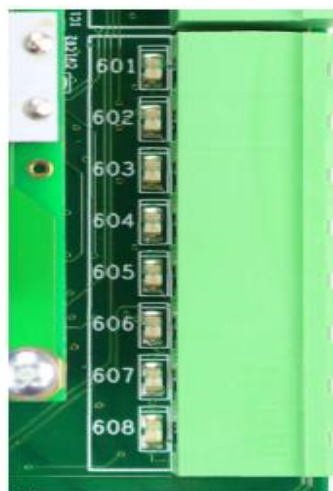

Figure 17: 24 VDC Output Connector

2.1.8 24 VDC Monitoring System

The monitoring connector is used to monitor the system. All terminals have a corresponding LED list when active.

- **CUP and CDN Inputs:** runs the car UP or DOWN using external run box.
- **MM Terminal:** puts the controller in either the Construction Mode (when the INSPECTION switch is on) or Test Mode (when the INSPECTION switch is off). To activate this input, a jumper must be installed from the 24 VDC to the input.
- **CEN Terminal:** monitors the status of the enable contact on the external run box during Construction Mode. This input must be enabled before the CUP and CDN buttons.



Figure 18: 24 VDC Monitoring System Connector

2.1.9 Safety String Inputs 120 VAC

WARNING

ALL CONNECTIONS ON THIS TERMINAL BLOCK ARE HIGH VOLTAGE - DISCONNECT POWER TO THE CONTROLLER BEFORE WIRING THESE TERMINALS.

This terminal block contains the connections for the controller safety string. Each input is always monitored (including Construction Mode). The source and termination for all Machine Room and Hoistway safeties are located on this terminal block.

All terminals have a corresponding LED list when active.

- **PIT Terminal:** termination of the Pit switch. The primary side of the switch is connected to H120 and the secondary side is then wired back to the PIT terminal.
- **BUF Terminal:** termination of the Buffer switch. The primary side of the switch is connected to H120 and the secondary side is then wired back to the BUF terminal.
- **TFL Terminal:** termination of the Top Final Limit switch. The primary side of the switch is connected to H120 and the secondary side is then wired back to the TFL terminal.

- **BFL Terminal:** termination of the Bottom Final Limit switch. The primary side of the switch is connected to H120 and the secondary side is then wired back to the BFL terminal.
- **H120 Terminal:** internal fused source for all hoistway safeties. This is used to power the PIT, BUF, BFL, TFL, and any other additional hoistway safety devices.

See the *Hydro:Evolved Controller* sheet 5 MR Board wiring information.

- **SFM Terminal:** termination of all Machine Room safety devices that do not have a dedicated input; for example, Run/Stop switch. All additional devices are wired in series and terminated to the SFM, for example, relays (EB1-EB4) check if it is safe to run the motor.
- **SFH Terminal:** termination of all hoistway safety devices that do not have a dedicated input. All additional devices are wired in series and terminated to the SFH.

See the *Hydro:Evolved Controller* sheet 5 MR Board for wiring information.

- **M120 Terminal:** internal fused source for all Machine Room safeties.

See the *Hydro:Evolved Controller* sheet 5 MR Board for wiring information.



Figure 19: Safety String Input Connector

2.1.10 120 VAC Inputs and Outputs (Field)

WARNING

ALL CONNECTIONS ON THIS TERMINAL BLOCK ARE HIGH VOLTAGE - DISCONNECT POWER TO THE CONTROLLER BEFORE WIRING THESE TERMINALS.

The following are input terminals.

See the *Hydro:Evolved Controller* sheet 5 MR Board for wiring information.

- **ATU Terminal:** access Top Up controller termination.
- **ATD Terminal:** access Top Down controller termination.

- **ABU Terminal:** access Bottom Up controller termination.
- **ABD Terminal:** access Bottom Down controller termination.

The following is an output terminal.

- **EB Terminal:** connects the neutral voltage to the Valve board. The EB terminal will not output voltage until all safety checks have been completed. See *Hydro:Evolved Controller sheet 5 MR Board* for wiring information.



Figure 20: 120 VAC Input and Output Connector

2.1.11 Hall Lock Connections

WARNING

ALL CONNECTIONS ON THIS TERMINAL BLOCK ARE HIGH VOLTAGE - DISCONNECT POWER TO THE CONTROLLER BEFORE WIRING THESE TERMINALS.

- **LRT Terminal:** terminates the rear top lock. The primary side of the lock is connected to L120 and the secondary side is wired back to this terminal.
- **LRM Terminal:** terminates the rear middle locks. The primary side of the lock is connected to L120 and the secondary side is wired back to this terminal.
- **LRB Terminal:** terminates the rear bottom lock. The primary side of the lock is connected to L120 and the secondary side is wired back to this terminal.
- **LFT Terminal:** terminates the front top lock. The primary side of the lock is connected to L120 and the secondary side is wired back to this terminal.
- **LFM Terminal:** terminates the front middle locks. The primary side of the lock is connected to L120 and the secondary side is wired back to this terminal.

- **LFB Terminal:** terminates the front bottom lock. The primary side of the lock is connected to L120 and the secondary side is wired back to this terminal.
- **L120 Terminals:** internally fused source for all lock voltages.



Figure 21: Hall Lock Connector

2.1.12 Inspection Controls

- **Enable Button:** enables power to the direction commands for inspection operation. This button must be pushed prior to issuing a direction to move on inspection.
- **Inspection Switch:** toggles between inspection and normal operation. When the MM input signal is high and the switch is set to INSPECTION, the system is in Construction Mode. If the switch is set to NORMAL, the system is in Test Mode.
- **Up and Down Buttons:** moves the car either up or down on Inspection and Construction Mode.
- **Car and Hall Door Bypass Switches:** bypasses the hall locks and Gate switch (GSW) only on CT and IC inspection. These switches are used instead of jumpers to reduce the risk of accidentally leaving a jumper still connected. These switches are not used in Construction Mode and the controller faults if used at any time outside CT or IC inspection.

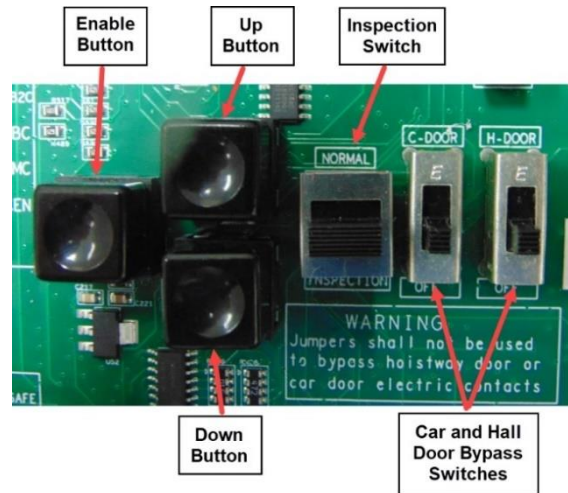

Figure 22: MR Board SR3032 Inspection Control

2.1.13 Safety Relays

- **SFM:** the force guided relay that is controlled by the main processor. The status of the relay is monitored by both the main processor and the safety processor. When the relay is active, contacts that are in series with SFP output voltage to the SAFE terminal are used to control the valves.
- **SFP:** the force guided relay that is controlled by the safety processor. The status of the relay is monitored by both the main processor and the safety processor. When the relay is active, contacts that are in series with SFM output voltage to the SAFE terminal are used to control the valves.
- **EB1:** the force guided relay that is controlled by the safety processor. The status of the relay is monitored by both the main processor and the safety processor. When the relay is active, contacts that are in series with EB2 pass through voltage from the EBS terminal to the EB terminal.
- **EB2:** the force guided relay that is controlled by the main processor. The status of the relay is monitored by both the main processor and the safety processor. When the relay is active, contacts that are in series with EB1 pass through voltage from the EBS terminal to the EB terminal.
- **EB3:** the force guided relay that is controlled by the safety processor. The status of the relay is monitored by both the main processor and the safety processor. When the relay is active, contacts that are in series with EB3 pass through voltage from the EBS terminal to the EB terminal.

- **EB4:** the force guided relay that is controlled by the main processor. The status of the relay is monitored by both the main processor and the safety processor. When the relay is active, contacts that are in series with EB1 pass through voltage from the EBS terminal to the EB terminal.

NOTE: EB3 and EB4 are only used during the preflight operation to bypass EB1 and EB2 relays so that they can be toggled without dropping the emergency brake.



Figure 23: MR Board SR3032 Safety Relays

2.2 CT/COP Board SR3030

The LEDs on the SRU board are either red, yellow, or green depending on the terminal and the status. Each color represents the following:

- **Red:** indicates a fault has been detected or the board is resetting.
- **Yellow:** indicates an active output terminal and alarm on the processors.
- **Green:** shows power on an input terminal, power to the board, and displays as a “heartbeat” to show the software is running on the processors.

Each LED on the CT/COP board has a reference designator.

The input terminals are labeled 501 through 5XX (508 on the MR board).

24 VDC is connected to the input terminals to run the logic circuitry.

WARNING

DO NOT APPLY AC CURRENT TO THE INPUT TERMINALS - APPLYING AC CURRENT WILL DAMAGE THE BOARD.

The output terminal is connected to the negative side of the load and provides a reference (REF) signal. The positive side of the load is connected to a 24 VDC power source.

If the yellow LED is not lit, the output transistors have no output and there is no load actuation.

WARNING

DO NOT APPLY 24 VDC DIRECTLY TO THE OUPUT TERMINAL WITHOUT A CURRENT LIMITING DEVICE - THIS WILL CAUSE DAMAGE TO THE OUTPUT TRANSISTORS.

The serial communication is as follows:

- **1* (CN2+ CN2-):** serial communication from the CT to the MR board for safety network.
- **2* (CN1+ CN1-):** serial communication for devices on the car network.
- **3* (C3H and C3L):** serial communication to third-party devices; for example, the Fixture Driver board.

CAT5*: the CAT5 supplies power and two serial communication channels.

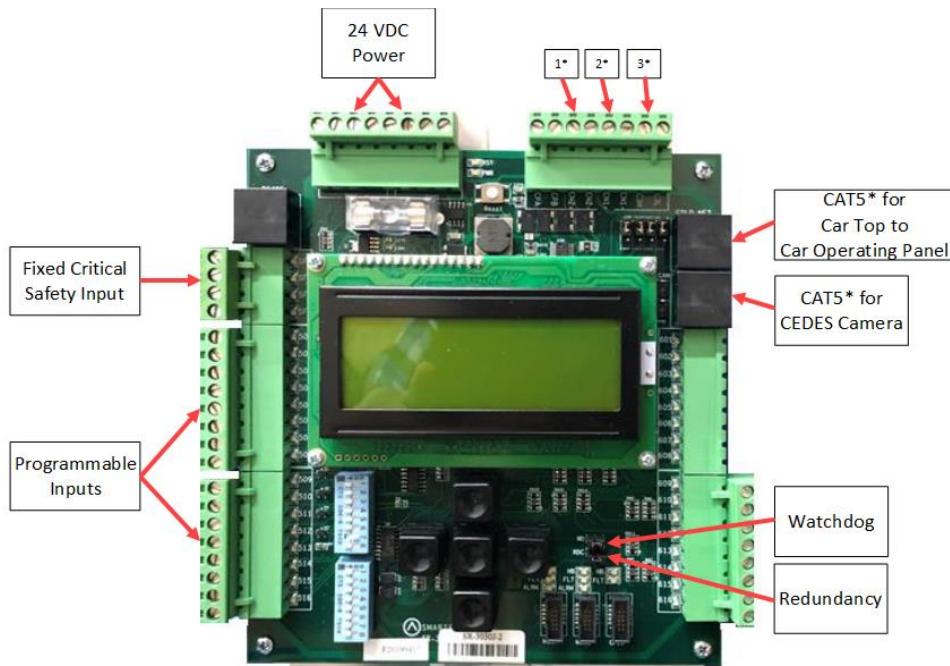

Figure 24: SRU Board SR3030

There are two sets of DIP switch settings for the SR3030 board. Bank A (upper) and Bank B (lower). Each setting is configured for a different functionality.

The table below lists the functionality and configuration for the CT/COP board SR3030 Bank A DIP switch setting.

Table 4: CT/COP Board SR3030 Bank A DIP Switch Setting Configuration

DIP Switch	Functionality	Description
DIP 1	CPU Stop Switch	Halts parameters updates and used to reset some latched faults.
DIP 2	N/A	N/A
DIP 3	N/A	N/A
DIP 4	N/A	N/A

DIP Switch	Functionality	Description
DIP 5	N/A	N/A
DIP 6	N/A	N/A
DIP 7	Pop-up Blocker	Disables the fault pop-up messages. Faults can still be viewed in the active and logged faults.
DIP 8	N/A	N/A

The table below lists the functionality configuration for the CT/COP board SR3030 Bank B DIP switch setting.

Table 5: CT/COP Board SR3030 Bank B DIP Switch Setting Configuration

DIP Switch	Functionality	Description
DIP 1	COP (not CT)	Must be turned on for COP operation and off for CT operation.
DIP 2	Enable Rear Doors	Must be set if rear doors are present.
DIP 3	N/A	N/A
DIP 4	N/A	N/A
DIP 5	N/A	N/A
DIP 6	N/A	N/A
DIP 7	N/A	N/A
DIP 8	N/A	N/A

2.3 I/O Board/Riser Board SR3031

The SR3031 Board serves two purposes:

- Designated as a Riser board (DIP 8 is ON) for fire service or emergency power connections and hall network connections.
 - Additional Riser boards are added by increasing the address by one; for example, Riser board 2 has DIP 8 and DIP 1 ON. Up to four Riser boards can be used within the system.
- Designated as an Expansion board (DIP 8 is OFF) to provide 24 VDC inputs and outputs that can be programmed as required.
 - Expansion boards are broken up into groups of eight. Up to 40 Expansion boards can be used within the system.

The Master/Slave switch is used to enable the secondary CAN network on the SR3031 board. When the switch is in the slave position, CAN1 and CAN2 terminals are identical and service the same network. When the switch is in the master position, CAN1 and CAN2 terminals are different and service different networks.

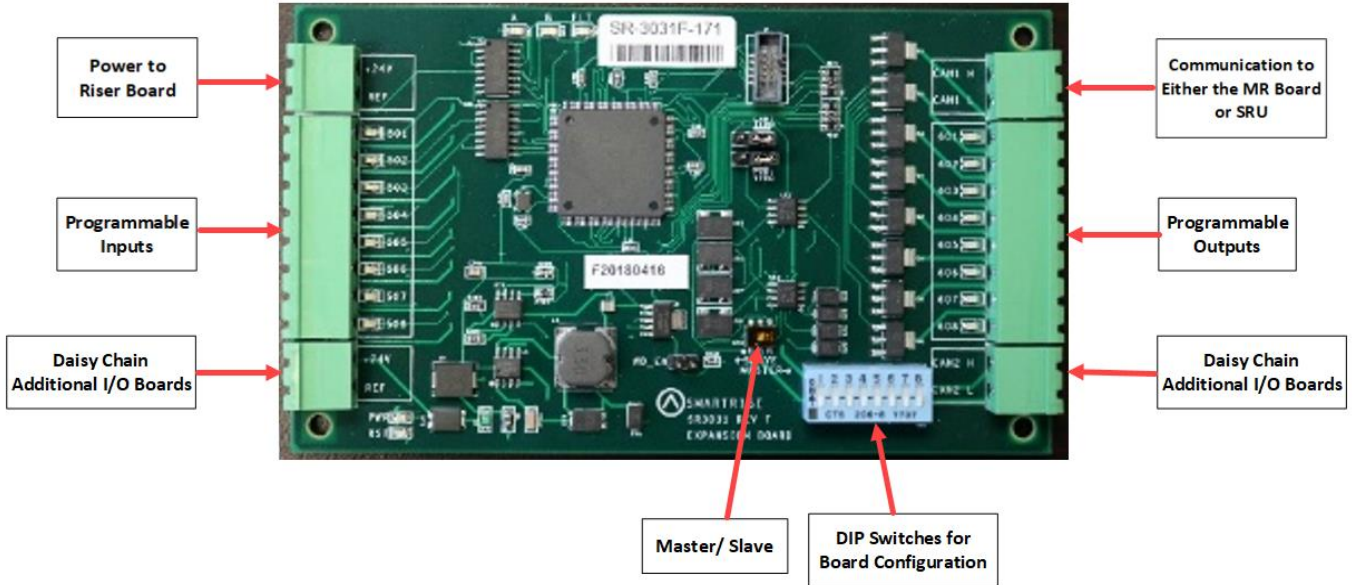

Figure 25: I/O Board/Riser Board SR3031

The table below lists the I/O Board SR3031 DIP switch settings.

Table 6: I/O Board SR3031 DIP Switch Settings

DIP Switch	Functionality
DIP 1	Slave ID 1
DIP 2	Slave ID 2
DIP 3	Slave ID 3
DIP 4	I/O Master ID 1
DIP 5	I/O Master ID 2
DIP 6	I/O Master ID 3
DIP 7	I/O Master ID 4
DIP 8	Riser Board

2.3.1 Group Redundancy

The Group Redundancy monitors pre-communicating Riser board(s). Group Redundancy is dependent upon the number of Riser boards connected within the group. For example, if only one Riser board is connected, then only one Riser board is monitored for loss of communication. If four Riser boards are connected, then all four Riser boards are monitored for loss of communication.

If any communicating Riser boards loses communication for more than 10 seconds, a signal is sent to trigger a set of relays to shut down the primary set of Riser boards and start the redundant set.

If there are no Riser boards connected prior to power up, Group Redundancy will not monitor any Riser boards.

The system must have additional wiring for the Group Redundancy feature to operate:

- All I/Os between the primary and redundant Riser 1 boards needs to be wired in parallel.
- All Hall board communication between the primary and redundant Riser 1 boards needs to be wired in parallel.
- Additional wiring for the relays to control power to the primary and redundant Riser 1 boards.

2.4 24 Input Board SR3041

The 24 Input board serves the same purpose as the SR3031 I/O Expansion board with the exception that there are *NO* outputs. The 24 Input board has three sets of eight assigned inputs, which permits this board to replace three SR3031 I/O boards. Just like the SR3031 Expansion board, the 24 Input board can be daisy chained to either the SR3041 or SR3031 board.

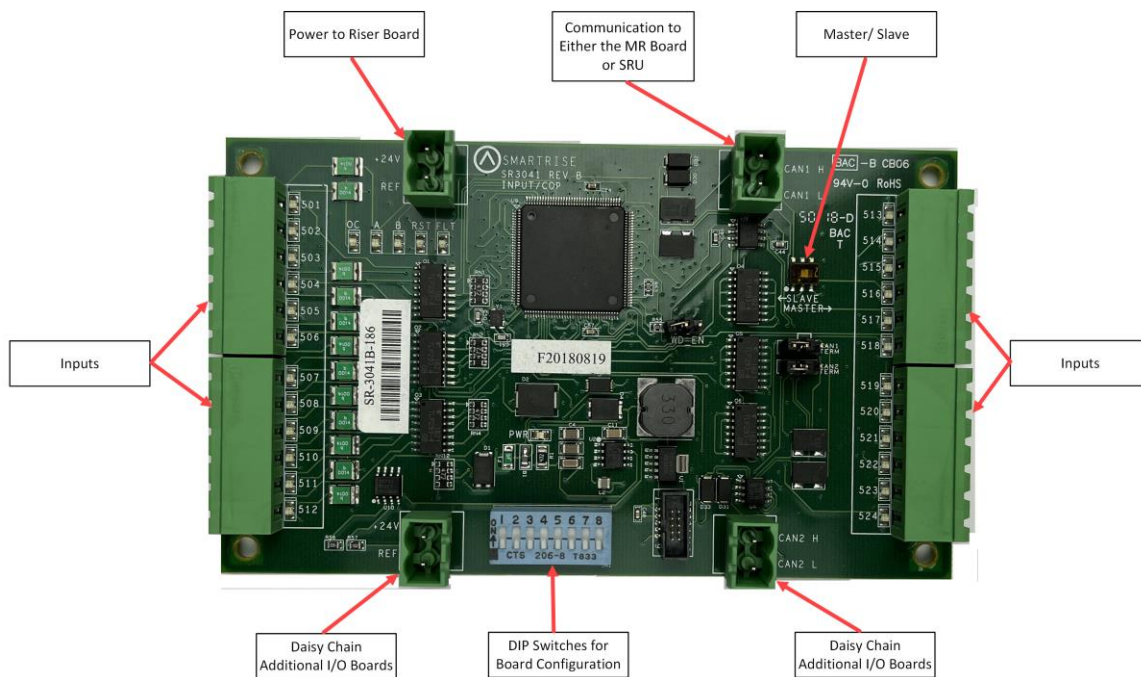

Figure 26: 24 Input Board SR3041

The serial communication is as follows:

- **CAN1:** the Master board connects to the COP board’s AUX net.
 - **CAN2:** the Master board connects to CAN1 of the slave board.
- NOTE:** CAN2 of each slave board will be connected to CAN1 to the following slave board.

The assigned input for wiring is as follows:

- Inputs 501-508: first address
- Inputs 509-516: second address
- Inputs 517-524: last address

The table below lists the 24 Input Board SR3041 DIP switch settings.

Table 7: 24 Input Board SR3041 DIP Switch Settings

DIP Switch	Functionality
DIP 1	Slave ID 1
DIP 2	Slave ID 2
DIP 3	Slave ID 3
DIP 4	I/O Master ID 1
DIP 5	I/O Master ID 2
DIP 6	I/O Master ID 3
DIP 7	I/O Master ID 4
DIP 8	Unused

NOTE: This board will occupy the expansion board address shown on its DIPs, as well as the next two slave addresses.

Depending on the location of the 24 Input board on the controller, the DIP switches have to be set to certain positions.

The address of the board depends on the type of board previously used. If the previous board is a SR3041, the address is the previous board’s address +3. If the previous board is a SR3031, the address is the previous board’s address +1.

If this Input board is the first board within the chain, turn OFF all DIP switches. The 24 Input board will mimic SR3031 Expansion boards (1-3).

If this Input board follows directly after the first 24 Input board in the chain, turn ON DIP switches 1 and 2 only. The 24 Input board will mimic SR3031 Expansion boards (4-6).

If another 24 Input board follows directly after the first two 24 Input boards within the chain, turn ON DIP switches 2 and 3 only. The 24 Input board will mimic SR3031 Expansion boards (7-9).

The table below lists the DIP switch settings for the 24 Input board when SR3041 is the master.

Table 8: 24 Input Board SR3041 DIP Switch Settings When SR3041 is Master

Board Type	DIP 1	DIP 2	DIP 3	DIP 4	DIP 5	DIP 6	DIP 7	DIP 8
SR30041 (Master)								
SR3041 (Slave)	X	X						
SR3041 (Slave)		X	X					

The table below lists the DIP switch settings for the 24 Input board when SR3031 is the master.

Table 9: 24 Input Board SR3041 DIP Switch Settings When SR3031 is Master

Board Type	DIP 1	DIP 2	DIP 3	DIP 4	DIP 5	DIP 6	DIP 7	DIP 8
SR3031 (Master)								
SR3041 (Slave)	X							
SR3041 (Slave)			X					

X = Turn DIP switch ON

2.5 Hall Board SR1060

The Hall Board SR1060 is wired discreetly. It is also used as the power source for the buttons and lamps on the fixture. Depending upon the controller configuration, a 10 DIP or 12 DIP switch Hall board is used. See Table 10 and Table 11 for switch settings.

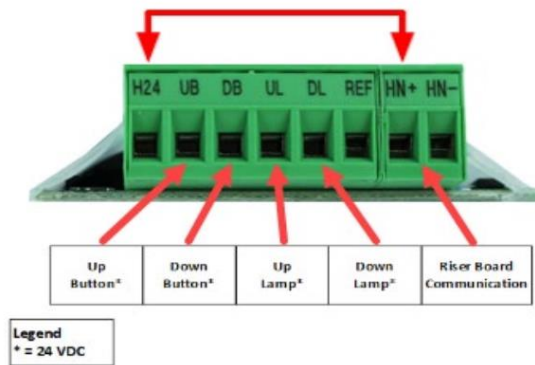

Figure 27: 10 DIP Hall Board SR1060-E

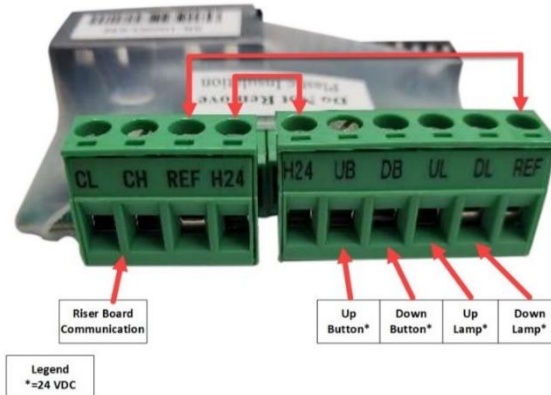

Figure 28: 12 DIP Hall Board SR1060-G

There are two ways the Hall board communicates with the Riser board:

- CAN bus via twisted pair
- CAT5

The table below lists the Hall Board 10 DIP switch settings.

Table 10: Hall Board 10 DIP Switch Settings

DIP Switch	Functionality
DIP 1	Landing ID 1
DIP 2	Landing ID 2
DIP 3	Landing ID 3
DIP 4	Landing ID 4
DIP 5	Landing ID 5
DIP 6	Landing ID 6
DIP 7	Function ID 1
DIP 8	Function ID 2
DIP 9	Function ID 3
DIP 10	CAN Termination

The table below lists the Hall Board 12 DIP switch settings.

Table 11: Hall Board 12 DIP Switch Settings

DIP Switch	Functionality
DIP 1	Landing ID 1
DIP 2	Landing ID 2
DIP 3	Landing ID 3
DIP 4	Landing ID 4
DIP 5	Landing ID 5
DIP 6	Landing ID 6
DIP 7	Landing ID 7
DIP 8	Function ID 1
DIP 9	Function ID 2
DIP 10	Function ID 3
DIP 11	N/A
DIP 12	CAN Termination

2.6 Valve Board SR3045

The Neutral input signal comes from the EB output from the MR board to the Valve board which controls when to either open or close the valves.

When valves are open, the oil flows from the cylinder and allows the car to move in either an up or down direction.

The Valve board controls the amount of oil that flows into the cylinders that is used to move the car to the selected floor.

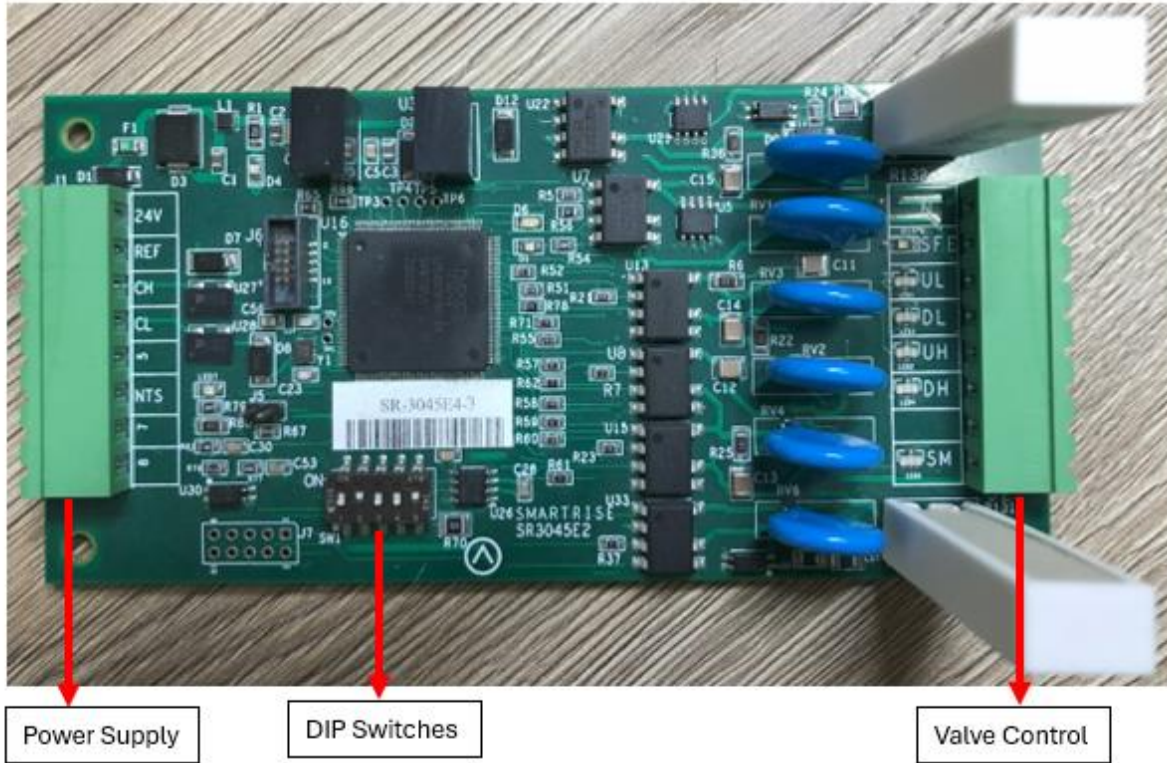

Figure 29: Valve Board SR-3045 Gen 3

- UL:** control signal to the valve when the car is moving at leveling speed in the up direction.
- DL:** control signal to the valve when the car is moving at leveling speed in the down direction.
- UH:** control signal to the valve when the car is moving at high speed in the up direction.
- DH:** control signal to the valve when the car is moving at high speed in the down direction.
- CH and CL:** communication between the Valve board and the MR board.
- DIP 1 & DIP 2:** Valve Select (see table below)

Table 12: Valve Select

DIP 1	DIP 2	Valve Board ID
OFF	OFF	1
OFF	ON	2
ON	OFF	3
ON	ON	4

- DIP3:** open Circuit Disable.
- DIP4:** WDT Disable.
- DIP5:** CAN Termination Resistor.

3 Menu Structures

The following figures display the menu options on the Hydro: Evolved.

NOTE: The navigation for the menu structure is set to where a specific output from a set of menus leads to an input with additional options.

3.1 Status

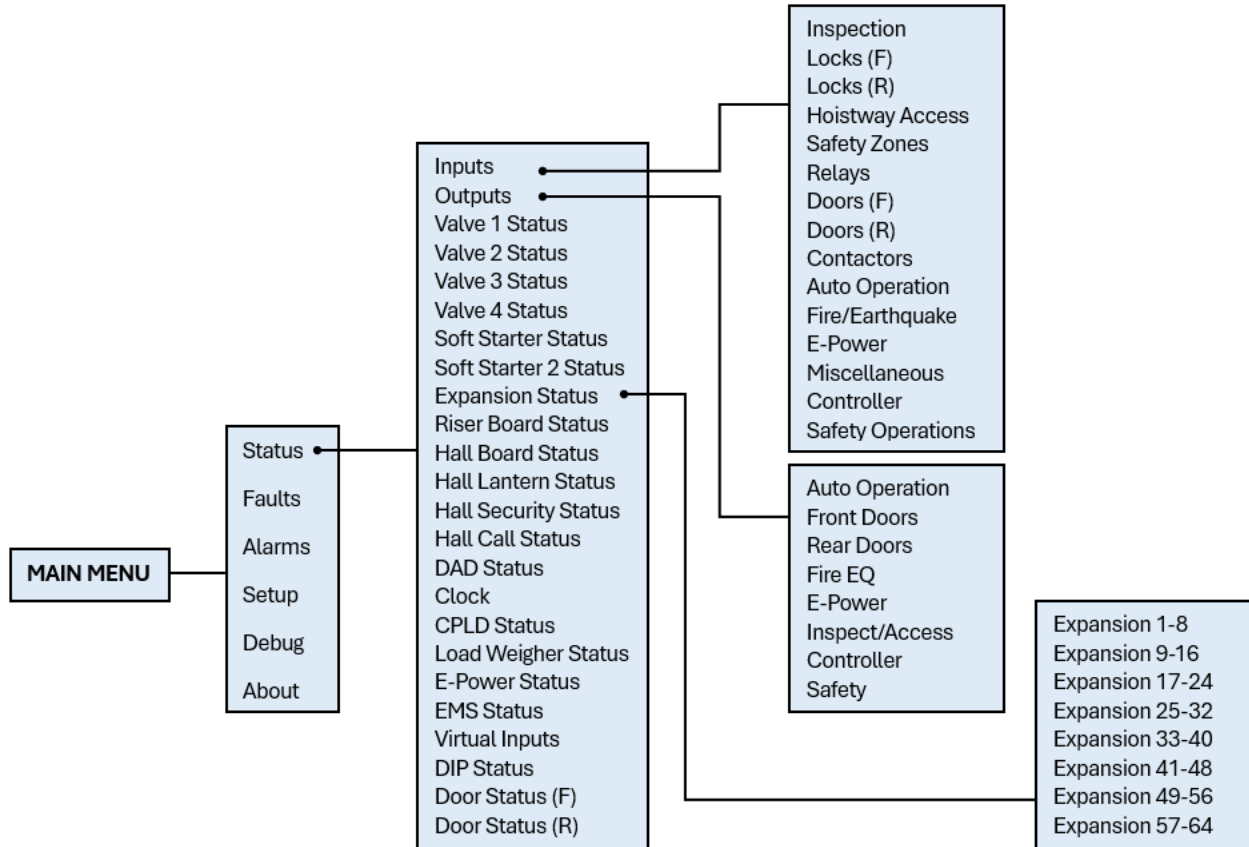

Figure 30: Status – Inputs, Outputs, and Expansion Status Menus

The table below lists the Status – Input, Outputs, and Expansion Status menu structures.

Table 13: Status – Inputs, Outputs, and Expansion Status Menu Structures

Menu	Description
MAIN MENU	
Status	Displays information about the current state of the controller
Status	
Inputs	Shows the status of all programmed inputs to the MR board
Outputs	Shows the status of all programmed outputs from the MR board
Valve 1 Status	Shows the status of Valve board
Valve 2 Status	Shows the status of the second Valve board

Menu	Description
Valve 3 Status	Shows the status of the third Valve board
Valve 4 Status	Shows the status of the fourth Valve board
Soft Starter Status	Shows the status of the soft starter
Soft Starter 2 Status	Shows the status of the secondary soft starter
Expansion Status	Shows communication status for a group of Expansion boards
Riser Board Status	Shows the status of the Riser board
Hall Board Status	Shows communication status for all Hall boards
Hall Lantern Status	Shows communication status for all Hall Lantern boards
Hall Security Status	Shows communication status for all Hall Security boards
Inputs	
Inspection	Shows the status of inspection related inputs
Locks (F) & (R)	Shows the status of all locks
Hoistway Access	Shows the status of all hoistway accesses
Safety Zones	Shows the status of safety inputs
Relays	Shows the status of all active relays
Doors (F) & (R)	Shows the status of all door operator signals
Contactors	Shows the status of all contactor monitoring signals
Auto Operation	Shows the status inputs under auto operation category
Fire/Earthquake	Shows the status of fire/earthquake inputs
E-Power	Shows the status E-Power inputs
Miscellaneous	Shows the status of various other inputs
Outputs	
Auto Operation	Shows the outputs that are in auto operation
Front Doors	Shows the status of front door outputs
Rear Doors	Shows the status of rear door outputs
Fire EQ	Shows the status of fire/earthquake outputs
E-Power	Shows the status of E-Power outputs
Inspect/ Access	Shows the status of inspection outputs
Controller	Shows the status of control outputs
Safety	Shows the status of safety outputs
Expansion Status	
Expansion 1-8	Shows the communication status for Expansion group 1
Expansion 9-16	Shows the communication status for Expansion group 2
Expansion 17-24	Shows the communication status for Expansion group 3
Expansion 25-32	Shows the communication status for Expansion group 4
Expansion 33-40	Shows the communication status for Expansion group 5
Expansion 41-48	Shows the communication status for Expansion group 6
Expansion 49-56	Shows the communication status for Expansion group 7
Expansion 57-64	Shows the communication status for Expansion group 8

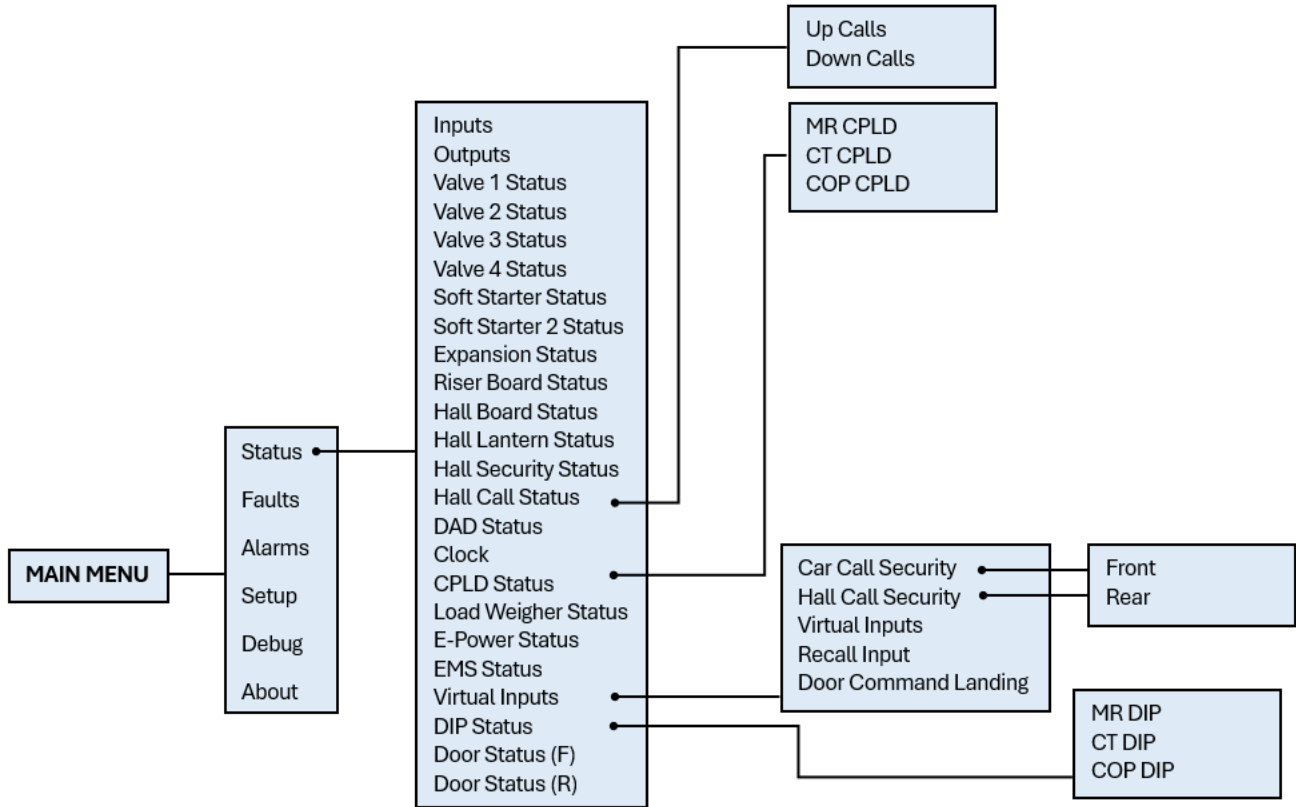

Figure 31: Status – Hall Call Status, CPLD Status, Virtual Inputs, and DIP Status Menus

The table below lists the Status – Hall Call Status, CPLD Status, Virtual Inputs, and DIP Status menu structures.

Table 14: Status – Hall Call Status, CPLD Status, Virtual Inputs, and DIP Status Menu Structures

Menu	Description
Status	
Hall Call Status	Shows the status of hall calls
DAD Status	Shows the status of DAD unit
Clock	View current clock setting on the system
CPLD Status	Shows the status of CPLDs
Load Weigher Status	Shows the status of the Load Weigher device
E-Power Status	Shows the status of emergency power
EMS Status	Shows the status of emergency medical service
Virtual Inputs	Shows the status of all inputs via remote access
DIP Status	Shows the status of the DIP switches
Door Status (F)	Shows the input status of a front door
Door Status (R)	Shows the input status of a rear door
Hall Call Status	
Up Calls	Shows list of latched up hall calls per car
Down Calls	Shows list of latched down hall calls per car

Menu	Description
CPLD Status	
MR CPLD	Shows MR current CPLD version, activity, and faults
CT CPLD	Shows CT current CPLD version, activity, and faults
COP CPLD	Shows COP current CPLD version, activity, and faults
Virtual Inputs	
Car Call Security	Shows status of car call security map set remotely
Hall Call Security	Shows status of hall call security map set remotely
Virtual Inputs	Shows the status of variety of inputs set remotely by remote monitoring system
Recall Input	Shows the recall floor and door that opens when remote recall to floor input is asserted
Door Command Landing	Shows the status of a door to a designated landing
DIP STATUS	
MR DIP	Shows the status of MR DIP switches that are On
CT DIP	Shows the status of CT DIP switches that are On
COP DIP	Shows the status of COP DIP switches that are On

3.2 Faults and Alarms

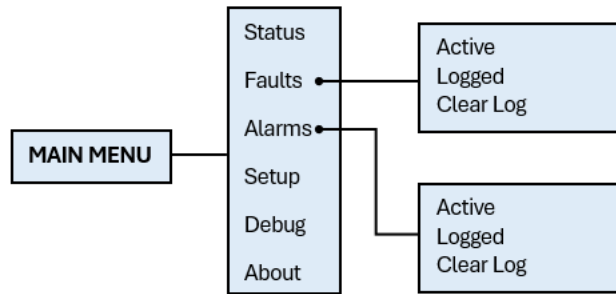

Figure 32: Faults and Alarms Menu

The table below lists the Faults and Alarms menu structures.

Table 15: Faults and Alarms Menu Structures

Menu	Description
MAIN MENU	
Faults	Allows the user to access Fault data
Alarms	Allows the user to access Alarm data
Faults	
Active	Displays current active faults that are preventing the car from running

Menu	Description
Logged	Displays the 32 latest faults stored in the systems non-volatile memory with the most recent faults at the top
Clear Log	Clears the fault log history
Alarms	
Active	Displays current active alarms
Logged	Displays the 32 latest faults stored in the systems non-volatile memory with the most recent faults at the top
Clear Log	Clears the alarm log history

3.3 Setup

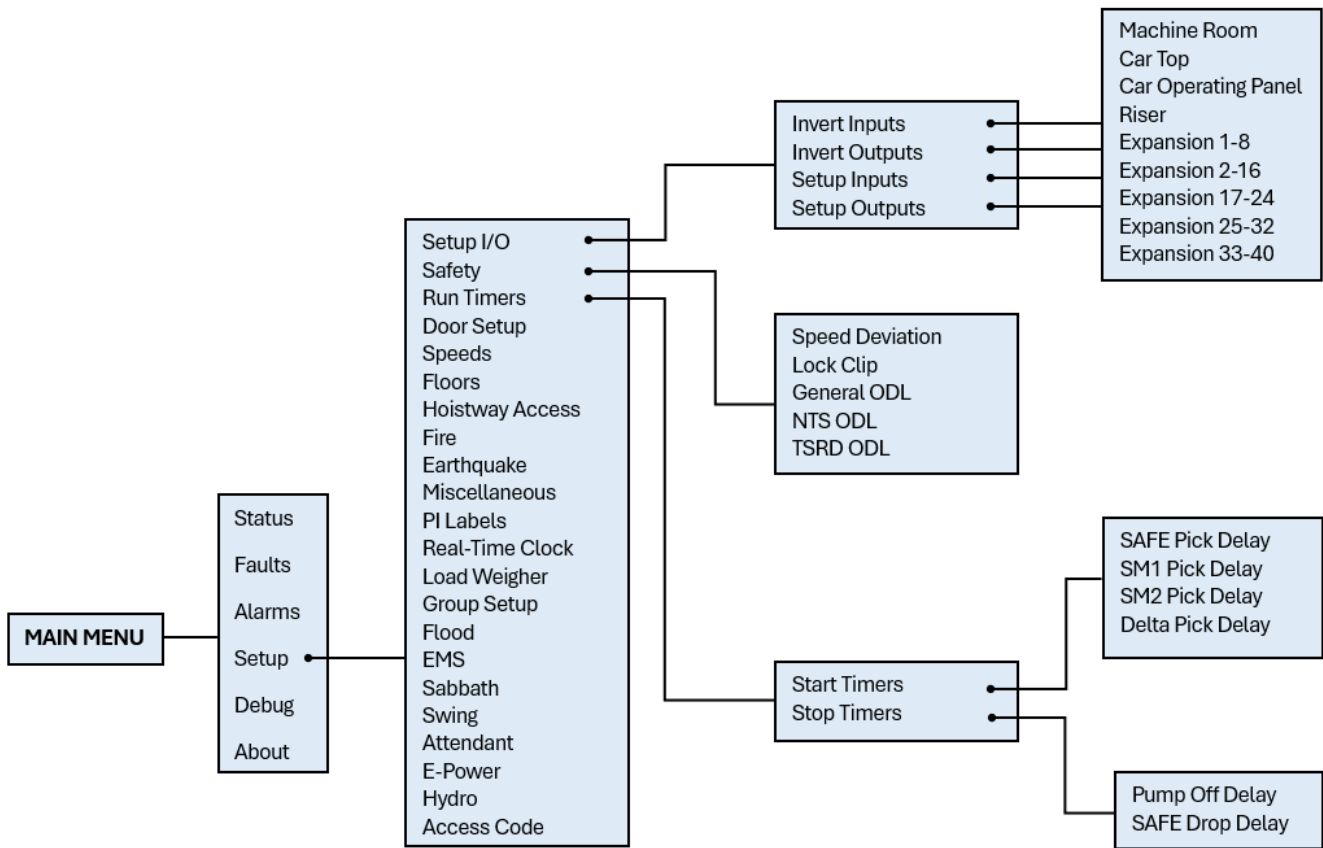

Figure 33: Setup – Setup I/O, Safety, and Run Timers Menus

The table below lists the Setup – Setup I/O, Safety, and Run Timers menu structures.

Table 16: Setup – Setup I/O, Safety, and Run Timers Menu Structures

Menu	Description
MAIN MENU	
Setup	Allows the user to setup the elevator configuration
Setup	

Menu	Description
Setup I/O	Configure inputs and outputs
Safety	Allows the user to adjust safety related functions
Run Timers	Adjust start sequence and stop sequence timers
Setup I/O	
Invert Inputs	Invert selected inputs
Invert Outputs	Invert selected outputs
Setup Inputs	Assign inputs
Setup Outputs	Assign outputs
Invert Inputs	
Machine Room	Change state of input to the MR board
Car Top	Change state of input to the CT board
Car Operating Panel	Change state of input to the COP board
Riser	Change state of input to the Riser board
Expansion 1-8	Change state of input to the Expansion 1-8 boards
Expansion 9-16	Change state of input to the Expansion 9-16 boards
Expansion 17-24	Change state of input to the Expansion 17-24 boards
Expansion 25-32	Change state of input to the Expansion 25-32 boards
Expansion 33-40	Change state of input to the Expansion 33-40 boards
Invert Outputs	
Machine Room	Change state of output to the MR board
Car Top	Change state of output to the CT board
Car Operating Panel	Change state of output to the COP board
Riser	Change state of output to the Riser board
Expansion 1-8	Change state of output to the Expansion 1-8 boards
Expansion 9-16	Change state of output to the Expansion 9-16 boards
Expansion 17-24	Change state of output to the Expansion 17-24 boards
Expansion 25-32	Change state of output to the Expansion 25-32 boards
Expansion 33-40	Change state of output to the Expansion 33-40 boards
Setup Inputs	
Machine Room	Assign inputs to the MR board
Car Top	Assign inputs to the CT board
Car Operating Panel	Assign inputs to the COP board
Riser	Assign inputs to the Riser board
Expansion 1-8	Assign inputs to the Expansion 1-8 boards
Expansion 9-16	Assign inputs to the Expansion 9-16 boards
Expansion 17-24	Assign inputs to the Expansion 17-24 boards
Expansion 25-32	Assign inputs to the Expansion 25-32 boards
Expansion 33-40	Assign inputs to the Expansion 33-40 boards
Setup Outputs	
Machine Room	Assign outputs from the MR board
Car Top	Assign outputs from the CT board

Menu	Description
Car Operating Panel	Assign outputs from the COP board
Riser	Assign outputs from the Riser board
Expansion 1-8	Assign outputs from the Expansion 1-8 boards
Expansion 9-16	Assign outputs from the Expansion 9-16 boards
Expansion 17-24	Assign outputs from the Expansion 17-24 boards
Expansion 25-32	Assign outputs from the Expansion 25-32 boards
Expansion 33-40	Assign outputs from the Expansion 33-40 boards
Safety	
Speed Deviation	Adjust speed deviation options
Lock Clip	The amount of time the controller disregards an open hall lock. This prevents intermittent interlock faults and for safety reasons, this timer should not exceed five seconds
General ODL	General overspeed debounce limit
NTS ODL	NTS overspeed debounce limit
TSRD ODL	TSRD overspeed debounce limit
Run Timers	
Start Timers	Timers used for motion start sequence
Stop Timers	Timers used for motion stop sequence
Start Timers	
SAFE Pick Delay	Sets the delay between activating the MR SAFE output and activating the primary start motor output when moving in the up direction. Sets delay between activating the SAFE output and activating the valve when moving in the down direction.
SM1 Pick Delay	Sets delay between activating the primary start motor output and activating the valve when moving in the up direction.
SM2 Pick Delay	Sets delay between activating the secondary start motor output and activating the valve when moving in the up direction.
Delta Pick Delay	Sets delay between activating the Delta output and activating the valve outputs
SAFE Pick Delay	Sets the delay between activating the MR SAFE output and activating the primary start motor output when moving in the up direction. Sets delay between activating the SAFE output and activating the valve when moving in the down direction.
Stop Timers	
Pump Off Delay	Sets delay between how long the pump motor continues to run after closing the Up valves
Safe Drop Delay	Sets delay between the time between deactivating the pump motor and turning off the MR-SAFE output

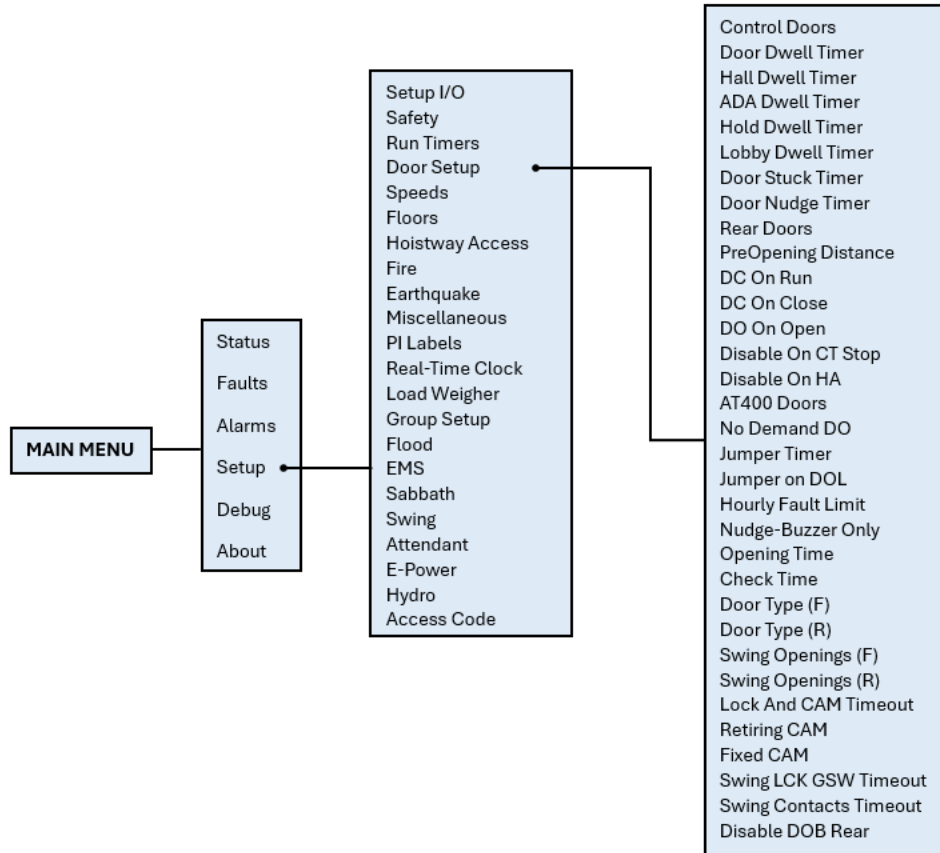

Figure 34: Setup - Door Setup Menu

The table below lists the Setup – Door Setup menu structure.

Table 17: Setup – Door Setup Menu Structure

Menu	Description
Setup	
Door Setup	Configure door parameters
Door Setup	
Control Doors	Allows for manually opening and closing the doors through the UI
Door Dwell Timer	Time car doors remains open when answer car calls
Hall Dwell Timer	Time car doors remain open when answering hall calls
ADA Dwell Timer	Time car doors remain open when answering ADA calls
Hold Dwell Timer (1 sec)	Time car doors remain open when responding to door hold button requests
Lobby Dwell Timer	Time car doors remain open when answering lobby calls
Door Stuck Timer (1 sec)	Time limit for a door to complete an opening or closing request before faulting
Door Nudge Timer (1 sec)	Time doors spend trying to close before transitioning to nudging which ignores photoeye. If set to zero, nudging is disabled.
Rear Doors	Enable or disable rear doors

Menu	Description
PreOpening Distance (.019")	The distance from a floor to start preopening doors. If zero, preopening is disabled.
DC On Run	Activates door close output while in motion
DC On Close	Activates door close output while the doors are in closed state
DO On Open	Activates door open output while the doors are in open state
Disable On CT Stop	When set ON, door outputs are suppressed when the CT Stop switch is active
Disable On HA	When set ON, door outputs are suppressed when on hoistway access inspection
AT400 Doors	When set to On, the option for AT400 door operator is enabled (if applicable).
No Demand DO	Doors remain open while the car is idle
Jumper Timer (100 ms)	Timer for jumper on Gate switch (F98/F107) and jumper on lock (F99/F108) faults. This value is added to a minimum timeout of 1.6 seconds.
Jumpers On DOL	When set to ON, detects jumper on GSW due to a discrepancy between GSW and DOL signal. When set to OFF, detects jumper on GSW due to a discrepancy between GSW and inverted DCL signal.
Hourly Fault Limit	The number of door faults allowed within 1-hour window before the car goes out of service. If the car goes out of service, it will remain out of service until the hour window elapses. If set to zero, this feature is disabled.
Nudge – Buzzer Only	When set ON during nudging, the NDG output is suppressed and only the buzzer sounds.
Opening Time (100ms)	The estimated time it takes the doors to go from fully closed to fully open. This value is learned after performing a run with preflight disabled (01-0064) and the learn opening time bit is ON (01-0165). This can help improve dwell time delays when preflight is on. If set to zero, this option is disabled.
Check Time (100ms)	Sets the time the car doors must be seen as safe before the car is allowed to start a run on automatic operation. Time is set in 100 ms counts. If zero, defaults to 300 ms.
Door Type (F)	Sets front door type
Door Type (R)	Sets rear door type
Swing Opening (F)	Enable or disable swing operation for each front door landing
Swing Opening (R)	Enable or disable swing operation for each rear door landing
Lock And CAM Timeout	Sets the timeout which accounts for the delay between CAM activation and locks being made for manual doors. The units are in 100 ms counts. If set to zero, value defaults to 4 seconds.
Retiring CAM	When set to ON, the CAM output controls hall interlocks. Otherwise, interlocks are controlled by the door operator.

Menu	Description
Fixed CAM	When set to ON, the door has a fixed hall CAM. The car is allowed to start a run without hall locks (hall closed contacts still required). The car is allowed to move up to 2 feet without locks before faulting.
Swing LCK GSW Timeout	Sets the timeout between GSW and locks. If value is zero, timeout is set to 500 ms. The units are in seconds.
Swing Contacts Timeout	Sets the timeout between CAM being energized and closed contacts being made. If value is zero, timeout is set to 500 ms. The units are in seconds.
Disable DOB Rear	When set to ON, the rear door on bottom floor is disabled

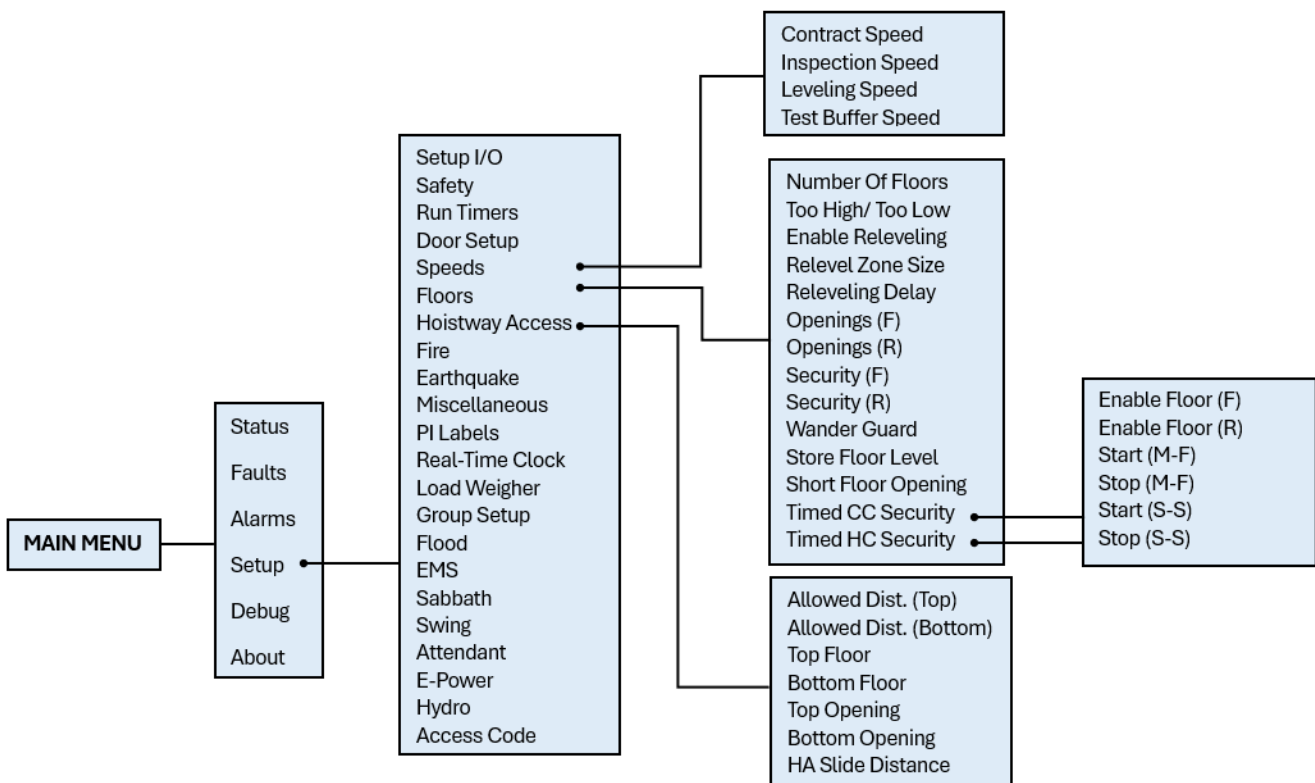

Figure 35: Setup – Speeds, Floors, and Hoistway Access Menus

The table below lists the Setup –Speeds, Floors and Hoistway Access menu structures.

Table 18: Setup – Speeds, Floors and Hoistway Access Menu Structures

Menu	Description
Setup	
Speeds	Configure speed parameters
Floors	Setup floor related parameters
Hoistway Access	Hoistway access setup menu

Menu	Description
Speeds	
Contract Speed	Contract Speed
Inspection Speed	Inspection Speed
Leveling Speed	Leveling Speed
Test Buffer Speed	Test Buffer Speed
Floors	
Number Of Floors	Allows for setting the number of floors within the building
Too High/ Too Low	Used to adjust the learned position of the floor when setting floor levels
Enable Releveling	Enables releveling operation
Relevel Zone Size (.02")	Sets the size of the releveling zone (dead zone)
Relevel Delay	The time the controller waits before engaging a Relevel command while in a door zone and outside the dead zone
Openings (F)	Allows for setting the floors the front door opens
Openings (R)	Allows for setting the floors the rear door opens
Security (F)	Allows for setting the security parameters for front door
Security (R)	Allows for setting the security parameters for rear door
Wander Guard	Allows for setting the wander guard feature for any floor
Store Floor Level	Sets the position of the short floor level
Short Floor Opening	Sets overlapping door zones (short floors)
Timed CC Security	Allows for setting car call security for specific times
Timed HC Security	Allows for setting hall call security for specific times
Time CC Security	
Enable Floor (F)	Allows for enabling timed security for front openings
Enable Floor (R)	Allows for enabling timed security for rear openings
Start (M-F)	Sets the time that floor access is denied during M-F
Stop (M-F)	Sets the time that floor access is resumed on M-F
Start (S-S)	Sets the time that floor access is denied during S-S
Stop (S-S)	Sets the time that floor access is resumed on S-S
Time HC Security	
Enable Floor (F)	Allows for enabling timed security for front openings
Enable Floor (R)	Allows for enabling timed security for rear openings
Start (M-F)	Sets the time that floor access is denied during M-F
Stop (M-F)	Sets the time that floor access is resumed on M-F
Start (S-S)	Sets the time that floor access is denied during S-S
Stop (S-S)	Sets the time that floor access is resumed on S-S

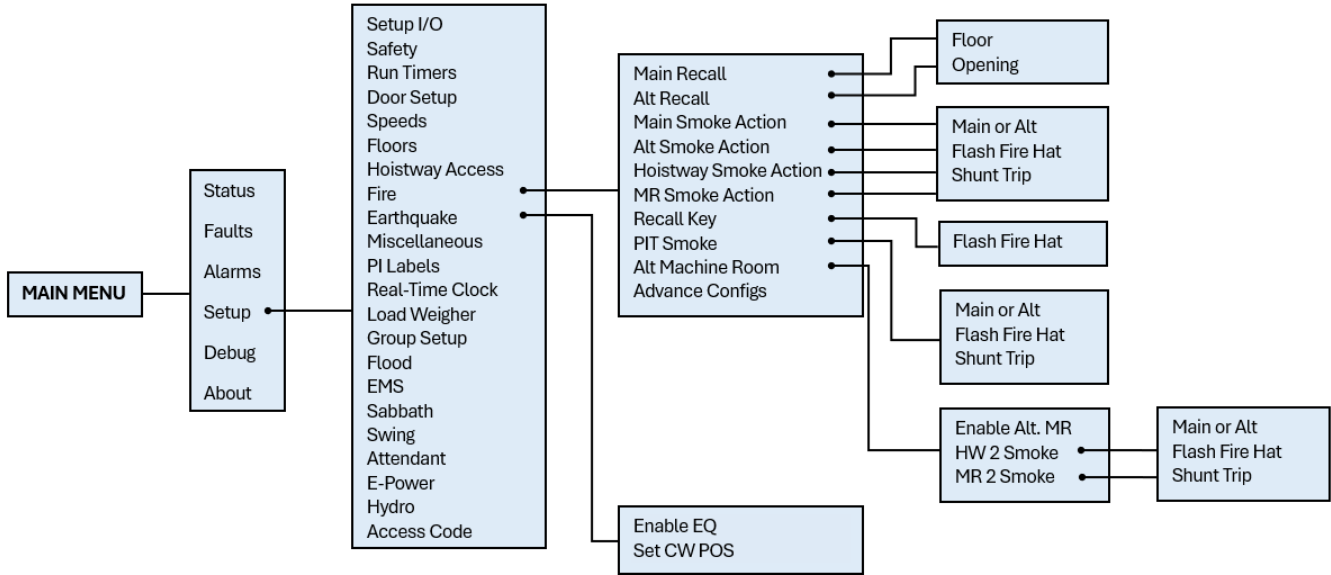

Figure 36: Setup –Fire, and Earthquake Menus

The table below lists the Setup –Hoistway Access, Fire, and Earthquake menu structures.

Table 19: Setup –Hoistway Access, Fire, and Earthquake Menu Structures

Menu	Description
Setup	
Fire	Fire operation setup menu
Earthquake	Earthquake operation setup menu
Fire	
Main Recall	Sets the main recall floor
Alt Recall	Sets the designated alternate recall floor
Main Smoke Action	Main smoke options
Alt Smoke Action	Alternate smoke options
Hoistway Smoke Action	Hoistway smoke options
MR Smoke Action	Machine room smoke options
Recall Key	Key to recall to service floor
PIT Smoke	Pit smoke options
Alt Machine Room	Secondary machine room smoke
Advance Configs	Additional fire features
Main Recall	
Floor	Sets the main fire recall floor This value is zero based, so the bottom most floor is zero
Opening	Sets the main recall opening as front or rear
Alt Recall	
Floor	Sets the alternate fire recall floor This value is zero based, so the bottom most floor is zero
Opening	Sets the main recall opening as front or rear

Menu	Description
Main Smoke	
Main or Alt	Sets whether the elevator will recall to the main or alternate landing when the main smoke is active
Flash Fire Hat	Flash fire hat when main smoke is active
Shunt Trip	Activates fire shunt output during Phase 1 recall if triggered by main smoke input
Alt Smoke	
Main or Alt	Sets whether the elevator will recall to the main or alternate landing when the alternate smoke is active
Flash Fire Hat	Flash fire hat when alternate smoke is active
Shunt Trip	Activates fire shunt output during Phase 1 recall if triggered by alternate smoke input
Hoistway Smoke	
Main or Alt	Sets whether the elevator will recall to the main or alternate landing when the hoistway smoke is active
Flash Fire Hat	Flash fire hat when hoistway smoke is active
Shunt Trip	Activates fire shunt output during Phase 1 recall if triggered by hoistway smoke input
MR Smoke	
Main or Alt	Sets whether the elevator will recall to the main or alternate landing when the machine room smoke is active
Flash Fire Hat	Flash fire hat when machine room smoke is active
Shunt Trip	Activates fire shunt output during Phase 1 recall if triggered by machine room smoke input
Recall Key	
Flash Fire Hat	Flash fire hat when recall key is turned to the ON position
PIT Smoke	
Main or Alt	Sets whether the elevator recalls to the main or alternate landing when the pit smoke is active
Flash Fire Hat	Flash fire hat when pit smoke is active
Shunt Trip	Activates fire shunt output during Phase 1 recall if triggered by pit smoke input
Alt Machine Room	
Enable Alt. MR	Enables alternate machine room fire operation setup menu
HW 2 Smoke	Alternate hoistway smoke options
MR 2 Smoke	Alternate machine room smoke options
HW 2 Smoke	
Main or Alt	Sets whether the elevator recalls to the main or alternate landing when alternate machine room smoke is active
Flash Fire Hat	Flash fire hat when alternate machine room smoke is active

Menu	Description
Shunt Trip	Activates fire shunt output during Phase 1 recall if triggered by alternate machine room smoke input
MR 2 Smoke	
Main or Alt	Sets whether the elevator recalls to the main or alternate landing when the alternate machine room smoke is active
Flash Fire Hat	Flash fire hat when alternate machine room smoke is active
Shunt Trip	Activates fire shunt output during Phase 1 recall if triggered by alternate machine room smoke input
Earthquake	
Enable EQ	Enables earthquake options
Set CW POS	Set the CW midpoint position

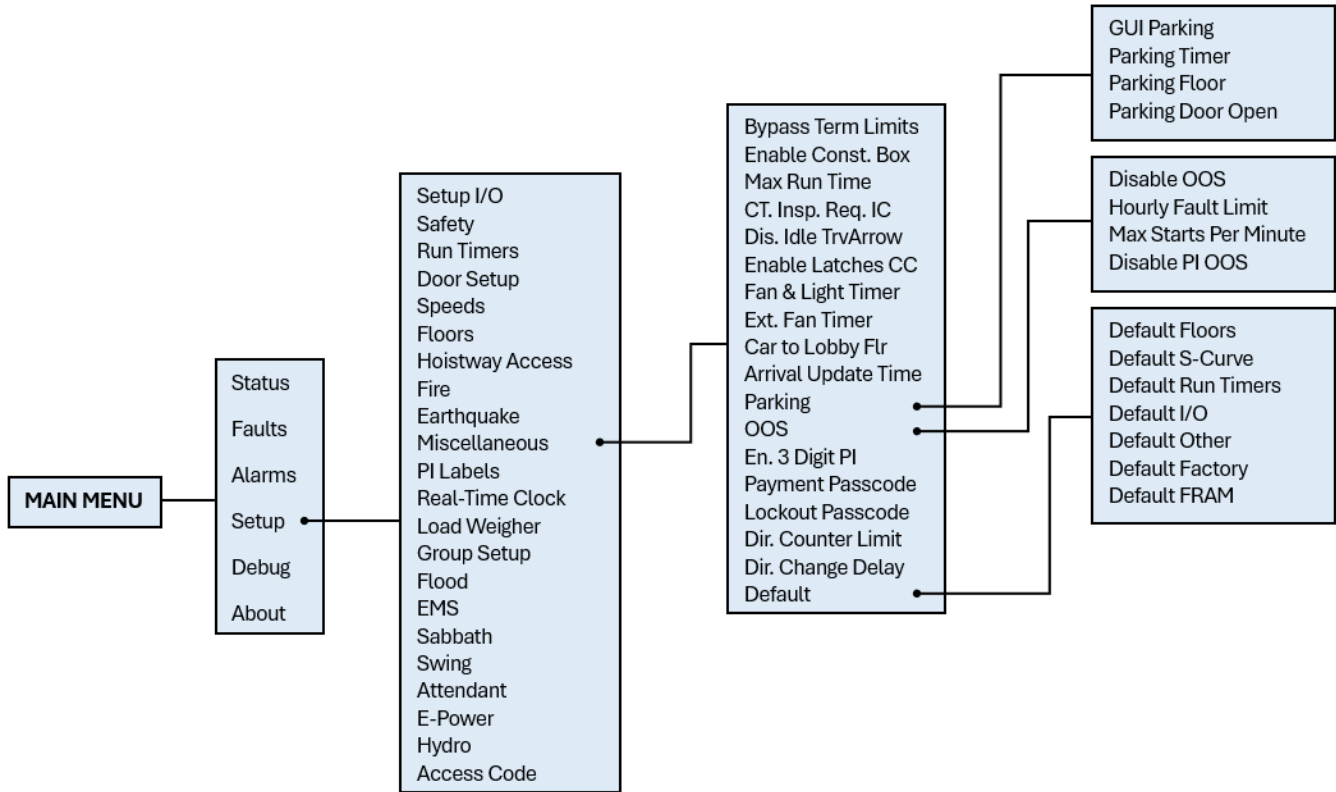

Figure 37: Setup – Miscellaneous Menu

The table below lists the Setup – Miscellaneous menu structures.

Table 20: Setup – Miscellaneous Menu Structures

Menu	Description
Setup	
Miscellaneous	Miscellaneous menu options
Miscellaneous	
ByPass Term Limit	Bypasses terminal limit faults. This option is automatically turned off when in automatic operation.
Enable Const. Box	Enable/Disable Construction Box. When enabled, onboard inspection buttons are ignored on construction operation and onboard inputs are used.
Max Run Time	Sets the max run time allowed in automatic operation before the car faults (F116). If set to zero, this fault is suppressed.
CT. Insp. Req. IC	Requires In-Car inspection to enable CT inspection
Dis. IdleTrvArrow	When set ON, CE travel arrows reflect the motion direction of the car. When set OFF, the arrows reflect the motion direction of the car and the arrival direction after a run.

Menu	Description
Enable Latches CC	When set ON, car call security enable input latches a car call
Fan & Light Timer	Sets the time the car may be idle before its fan and light output is turned off. If a longer timer is needed, the extended fan and light timer should be used instead. Units are in seconds.
Ext. Fan Timer	Extended fan and light timer
Car to Lobby Flr	Sets the floor the car moves to when the car to lobby input is activated. This value is zero based.
Arrival Update Time	Sets the time before arriving at a floor to update arrival lantern outputs. If set to zero, arrival outputs updates when doors begin to open. Units are in seconds.
Parking	Parking options
OOS	Car out of service options
En. 3 Digit PI	Enables 3-digit PI
Payment Passcode	Controller passcode
Lockout Passcode	Sets the screen lockout code which restricts access to allowed elevator personnel
Dir. Counter Limit	Sets a limit on the number of trips done in the opposite direction. Once it is exceeded, the car will go into OOS Mode.
Dir. Change Delay	Sets the time to delay car direction changes. Allows time for passengers to enter their car calls. Units are in 1 second counts.
Default	Parameter default options
Parking	
GUI Parking	Enable GUI parking
Parking Timer (1 sec)	Sets the time it takes before an idle car is parked. If set to zero, parking is disabled.
Parking Floor	Floor the car parks at
Parking Door Open	Enables parking with doors open
OOS	
Disable OOS	Disables the controller from going out of service due to reoccurring faults
Hourly Fault Limit	Sets the number of faults allowed within a 1-hour window before the car goes out of service. If the car goes out of service, it remains out of service until the hour window elapses.

Menu	Description
Max Starts Per Minute	Specifies how many times the car may attempt to start a run in automatic operation during a 1-minute window. If the controller attempts additional runs, the car goes out of service until the real-time clock increments to the next minute. Set this parameter to zero to disable the feature.
Disable PI OOS	When set ON, OOS does not flash on the PI when the car is out of group
Default	
Default Floors	Default learned floor values
Default S-Curve	Default Digital S-curve Technology™ (U.S. Patent Pending) values
Default Run Timers	Default Run Timer values
Default I/O	Default inputs and outputs
Default Factory	Restore all parameters to factory settings
Default FRAM	Set ON to default the FRAM chip. This option is self-resetting. This clears fault/alarm logs, latched faults, emergency bits and run counter.
Default Other	Defaults all miscellaneous values

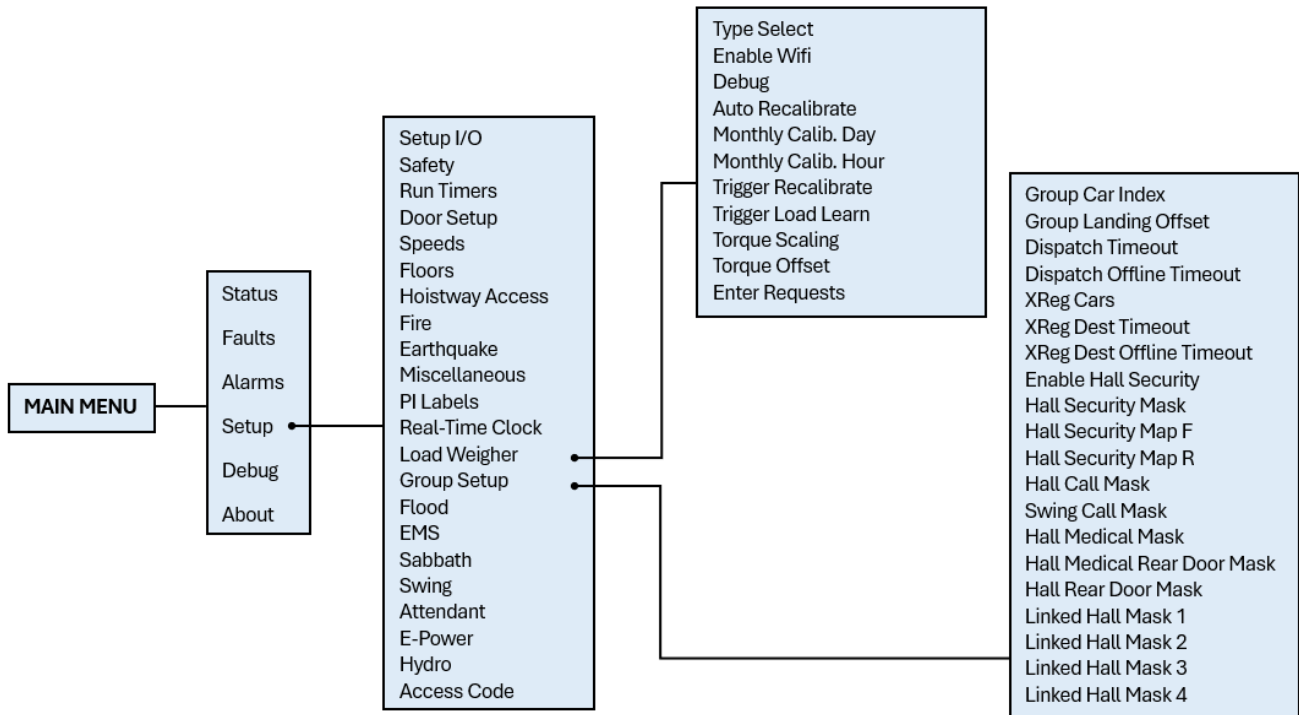

Figure 38: Setup – Load Weigher and Group Setup Menus

The table below lists the Setup – Load Weigher and Group Setup menu structures.

Table 21: Setup – Load Weigher and Group Setup Menu Structures

Menu	Description
Setup	
PI Labels	Set Position Indicator labels
Real-Time Clock	Set internal clock time for fault identification
Load Weigher	Load Weigher menu options
Group Setup	Group setup parameters
Load Weigher	
Type Select	Select the type of load weigh device used
Enable WiFi	Enables WiFi connection to load weighing device
Debug	When set to On, allows for viewing of load weighing device packet receive counts and raw load values
Auto Recalibrate	When set to On, the car regularly recalibrates its load weighing device.
Monthly Calib. Day	Day of the month the controller is set for monthly automatic load recalibration
Monthly Calib. Hour	Time of the day the controller is set for monthly automatic load recalibration
Trigger Recalibrate	When set to On, the car performs a load weighing device empty load recalibration.

Menu	Description
Trigger Load Learn	When set to On, the car performs load weighing device full load calibration.
Torque Scaling	Sets a scaling value to multiply by the torque output of the Smartrise load weighing device. The value is a signed 8-bit integer in percentage format.
Torque Offset	Sets an offset to add to the Smartrise load weighing device torque percentage output. Value is a signed 8-bit integer.
Enter Requests	Commands sent to load weighing device
Group Setup	
Group Car Index	Sets the car's group ID.
Group Landing Offset	Sets an offset to the bottom landing so hall calls can be aligned properly for all cars in a group. If car 1 serves landing 1 and car 2 starts servicing landing 2, then car 2 would have an offset of 1.
Dispatch Timeout (1 sec)	Sets the time the car has to respond to a destination assignment before it temporarily removes itself from the group and the call is be reassigned. This prevents excessive delays in answering hall calls due to someone holding open the car door. If either the dispatch timeout or dispatch offline are set to zero, this feature is disabled. Should be set to 0 if only one car is in the group.
Dispatch Offline (1 sec)	Sets the time the car removes itself from the group after failing to take an assigned call. If either the dispatch timeout or dispatch offline are set to zero, this feature is disabled.
XReg Cars	Sets the number of X-Reg cars to include in dispatching
XReg Dest Timeout (10 sec)	Sets the time the XReg car has to respond to a destination assignment before it temporarily removes itself from the group and the call is be reassigned. This prevents excessive delays in answering hall calls due to someone holding open the car door. If either the dispatch timeout or dispatch offline are set to zero, this feature is disabled.
XReg Dest Offline Timeout (10 sec)	Sets the time the XReg car removes itself from the group after failing to take an assigned call. If either the dispatch timeout or dispatch offline are set to zero, this feature is disabled.
Enable Hall Security	Enables Hall Security
Hall Security Mask	Turn ON/OFF which hall board function will have hall call security.
Hall Security Map Front	Turn ON/OFF Hall Call security for front landings
Hall Security Map Rear	Turn ON/OFF Hall Call security for rear landings

Menu	Description
Hall Call Mask	Turn ON/OFF which hall board function the car will respond to for hall calls
Swing Call Mask	Turn ON/OFF which hall board functions the car will treat as a swing hall call. NOTE: Swing call mask cannot overlap with Medical Mask or Hall Call Mask.
Hall Medical Mask	Turn ON/OFF which hall board functions the car will treat as Emergency Medical Service call. NOTE: Medical Mask cannot overlap with Swing call mask or Hall Call Mask.
Hall Medical Rear Door Mask	Turn ON/OFF which hall board functions the car will treat as rear Emergency Medical Service call. NOTE: Medical Mask cannot overlap with Swing call mask or Hall Call Mask.
Hall Rear Door Mask	Turn ON/OFF which hall board functions are for rear opening. This acts as a modifier to the mask it overlaps with.
Linked Hall Mask 1	First set of Hall board functions that are turned ON are linked together. If 01 is ON and 02 is ON, a hall call on function 1 would latch the lamp for function 2.
Linked Hall Mask 2	Second set of Hall board functions that are turned ON are linked together. If 01 is ON and 02 is ON, a hall call on function 1 would latch the lamp for function 2.
Linked Hall Mask 3	Third set of Hall board functions that are turned ON are linked together. If 01 is ON and 02 is ON, a hall call on function 1 would latch the lamp for function 2.
Linked Hall Mask 4	Fourth set of Hall board functions that are turned ON are linked together. If 01 is ON and 02 is ON, a hall call on function 1 would latch the lamp for function 2.

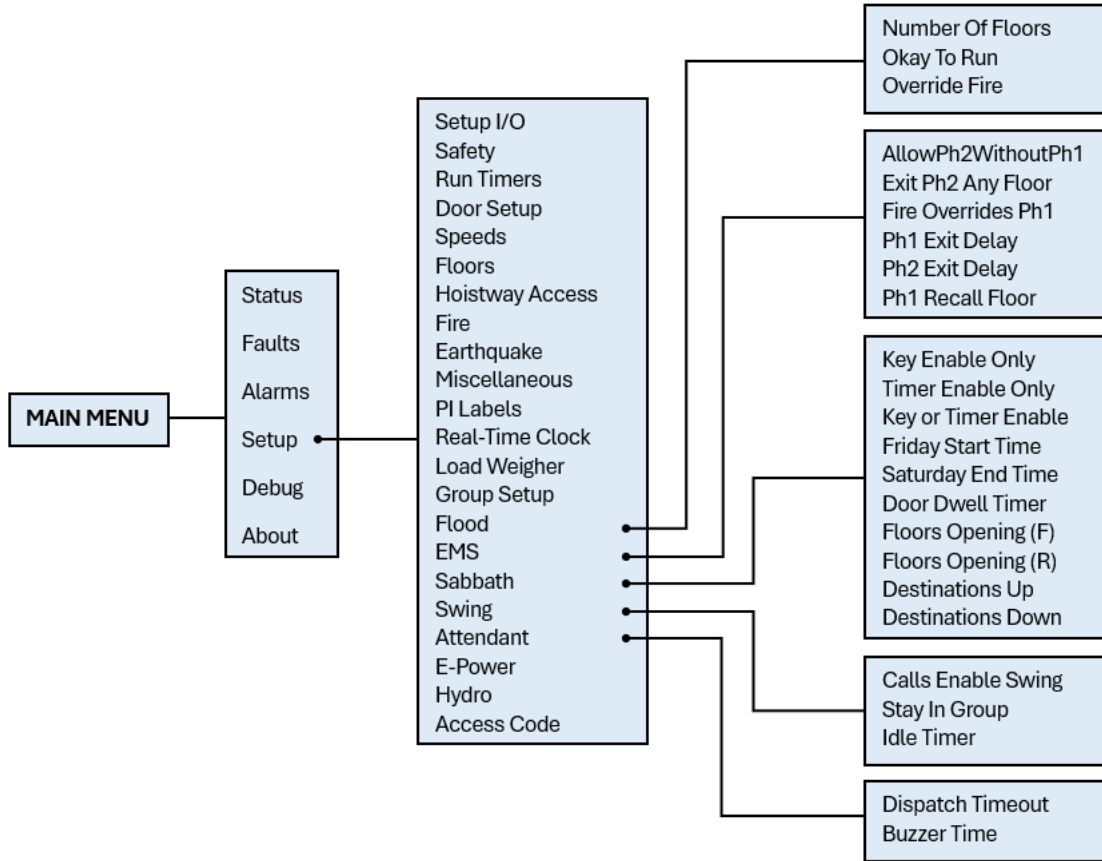

Figure 39: Setup – Flood, EMS, Sabbath, Swing, and Attendant Menus

The table below lists the Setup – Flood, EMS, Sabbath, Swing, and Attendant menu structures.

Table 22: Setup – Flood, EMS, Sabbath, Swing, and Attendant Menu Structures

Menu	Description
Setup	
Flood	Flood options
EMS	Emergency medical service options
Sabbath	Sabbath operation options
Swing	Swing operation options
Attendant	Attendant service options
Flood	
Number of Floors	Used in conjunction with the flood switch input. If a flood is detected, then this parameter tells the controller which floors to avoid. If set to zero, the elevator can go to all floors. If the flood switch is active and this parameter is set to one, then the car is not allowed to go to the bottom floor. If set to two, then elevator cannot go to bottom two floors, etc.

Menu	Description
Okay to Run	Allows car to continue to run above the configured flood sensor floor
Override Fire	Allows flood operation to take priority over fire operation
EMS	
Allow Ph2WithoutPh1	Allows activation of Medical Phase 2 even if the car was never placed on Phase 1
Exit Ph2 Any Floor	Allows exiting of EMS Phase 2 at any floor. Jobs with full hospital service should have this parameter turned ON. Jobs with EMT service should have this parameter OFF.
Fire Overrides Ph1	When set ON, the activation of a smoke or Fire Phase 1 key causes a car that is currently on EMS Phase 1 to exit medical service and go on Fire Phase 1 recall. When turned OFF, the car remains on EMS Phase 1.
Ph1 Exit Delay (1 sec)	When a car is called to a landing by an EMS Phase 1 key, this parameter specifies how long it will remain there before returning to normal operation if no one places it on EMS Phase 2.
Ph2 Exit Delay (1 sec)	Specifies how long to wait after exiting EMS Phase 2 before returning to normal operation. A programmable delay allows time for the patient to be removed from the elevator if EMS Phase 2 were turned off prior to removing the patient.
Ph1 Recall Floor	The floor at which the car recalls to during MA EMS mode.
Sabbath	
Key Enable Only	When set ON, Sabbath operations is only activated by keyswitch input
Timer Enable Only	When set ON, Sabbath operation is activated by only the configured Sabbath Start Time and Sabbath End Time
Key or Timer Enable	When set ON, Sabbath operation is activated by either keyswitch input or configured Sabbath Start Time and Sabbath End Time
Friday Start Time	Sets the Friday start time for Sabbath when timer enable is set. Format is HHMM, for example 12:34 PM would be 1234.
Saturday End Time	Sets the Saturday end time for Sabbath when timer enable is set. Format is HHMM, for example, 12:34 PM would be 1234.
Door Dwell Timer (1 sec)	Sets the time car doors remain open while in Sabbath operation
Sabbath (F)	Sets the front opening floors to be serviced during Sabbath operation

Menu	Description
Sabbath (R)	Sets the rear opening floors to be serviced during Sabbath operation
Destinations Up	Set which floors to stop at during Sabbath up operation
Destinations Down	Set which floors to stop at during Sabbath down operation
Swing	
Calls Enable Swing	Allows swing calls to activate swing operation
Stay in Group	Allows the car to continue to take regular hall calls while in swing operation
Idle Timer (1 sec)	If Swing Mode is entered by a button press, this timer specifies how long to remain in Swing operation once the car is idle
Attendant	
Dispatch Timeout	Sets the time the car removes itself from answering hall calls after failing to take an assigned call while on attendant service. If either the dispatch timeout or dispatch offline are set to zero, this feature is disabled. If only one car is on attendant service, this feature should be disabled.
Buzzer Time (100ms)	Specifies how long to sound the buzzer to alert the attendant that a hall call was pressed

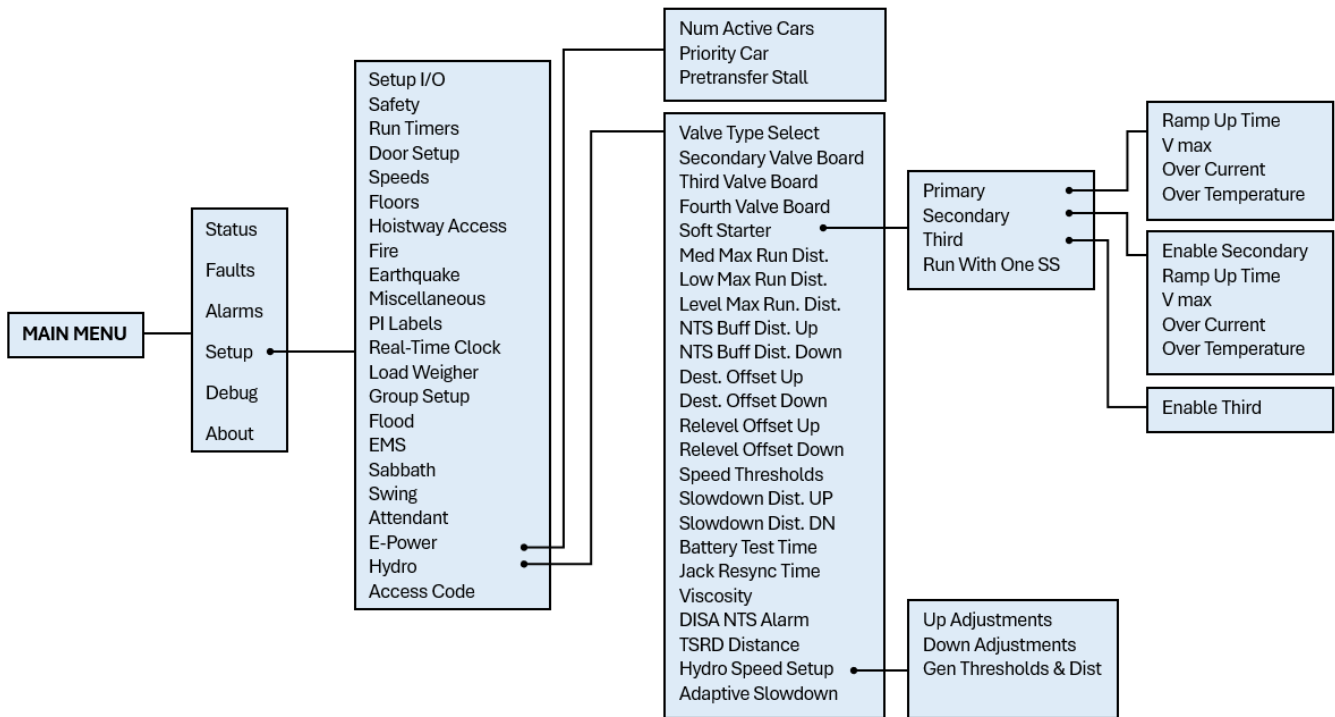

Figure 40: Setup – E-Power and Hydro Menus

The table below lists the Setup – E-Power and Hydro menu structures.

Table 23: Setup – E-Power and Hydro Menu Structures

Menu	Description
Setup	
E-Power	Emergency power options
Hydro	Hydro Operations
E-Power	
Num of Active Cars	Sets the number of cars allowed to run during emergency power operation
Priority Car	Sets the first car selected when on emergency power and when the auto select input is active.
Pretransfer Stall	When set ON, if the Emergency Power Pretransfer input is active, cars stop in a faulted state wherever they are. When set to OFF, cars instead move to the nearest landing and go out of service with the door open. This option is used when the system is wired to use pretransfer input to delay cars both at the transfer into and out of emergency power.
Hydro	
Valve Type Select	Allows the user to choose the type of valve used in the system
Secondary Valve Board	Checks for secondary Valve board when set to ON at startup
Soft Starter	Allows the user to select soft starter options
Med Max Run Dist.	Sets the maximum run distance when the medium valve speed run is selected. Longer runs will use the next higher speed valve. When set to zero, the valve is disabled.
Low Max Run Dist.	Sets the maximum run distance when the low valve speed run is selected. Longer runs will use the next higher speed valve. When set to zero, the valve is disabled.
Level Max Run Dist.	Sets the maximum run distance when the level valve speed run is selected. Longer runs will use the next higher speed valve. When set to zero, the valve is disabled.
NTS Buffer Dist. Up	Distance added to the slowdown distance to cut off high valves in the up direction
NTS Buffer Dist. Down	Distance added to the slowdown distance to cut off high valves in the down direction
Dest. Offset Up	Distance from the destination position that the car cuts its leveling valve when moving in the up direction on a non-releveling run

Menu	Description
Dest. Offset Down	Distance from the destination position that the car cuts its leveling valve when moving in the down direction on a non-releveling run
Relevel Offset Up	Distance from the destination position that the car cuts its leveling valve when moving in the up direction on a releveling run
Relevel Offset Down	Distance from the destination position that the car cuts its leveling valve when moving in the down direction on a releveling run
Speed Thresholds	Positioning system speed feedback is used for this comparison
Slowdown Dist. UP	Distance when the car starts slowing down on a normal run while moving in up direction
Slowdown Dist. DN	Distance when the car starts slowing down on a normal run while moving in down direction
Battery Test Time	Sets the time to check the battery board
Jack Resync Time	Sets the time to trigger Jack Resync
Viscosity	Sets the run time and rest time for viscosity
DISA NTS Alarm	Disables NTS alarms
TSRD Distance	Sets the distance to prevent car from hitting the buffer
Soft Starter	
Primary	Enables primary soft starter
Secondary	Enables secondary soft starter
Third	Enables third soft starter
Run With One SS	When set to ON, if two soft starters are supported, and only one of those soft starters is faulted, the car will still be allowed to run.
Primary	
Ramp Up Time	Sets the primary soft starter time to ramp up to V-Max
Vmax	Sets the primary soft starter percentage of input AC voltage used for ramp up
Over Current	Sets the primary soft starter overcurrent limit in amps
Over Temperature	Sets the primary soft starter over temperature limit in degrees Fahrenheit counts
Secondary	
Enable Secondary	Enables secondary soft starter
Ramp Up Time	Sets the secondary soft starter time to ramp up to V-Max
Vmax	Sets the secondary soft starter percentage of input AC voltage used for ramp up
Over Current	Sets the secondary soft starter overcurrent limit in amps
Over Temperature	Sets the secondary soft starter over temperature limit in degrees Fahrenheit counts

Menu	Description
Third	
Enable Third	
Hydro Speed Setup	
Up Adjustments	Adjust speed when transitioning from contract speed to leveling speed in the up direction
Down Adjustment	Adjust speed when transitioning from contract speed to leveling speed in the down direction
Generate Thresholds and Distance	Updates threshold and slowdown distances based on adjustment settings

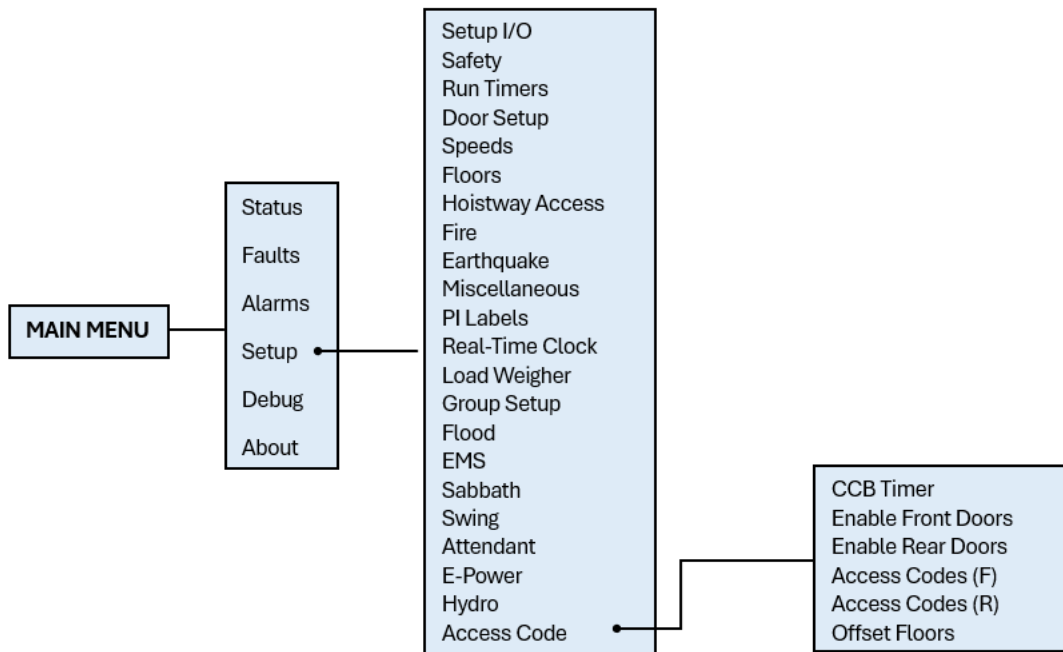

Figure 41: Setup – Access Code Menu

The table below lists the Setup – Access Code menu structures.

Table 24: Setup – Access Code Menu Structures

Menu	Description
Setup	
Access Code	Access code options
Access Code	
CCB Timer	Time for registering a car call after access code is entered
Enable Front Doors	Disables access code on front doors
Enable Rear Doors	Disables access code on rear doors
Access Code (F)	Code that gives access to front door car calls
Access Code (R)	Code that gives access to rear door car calls
Offset Floors	The first floors to offset when applying the access code

3.4 Debug and About

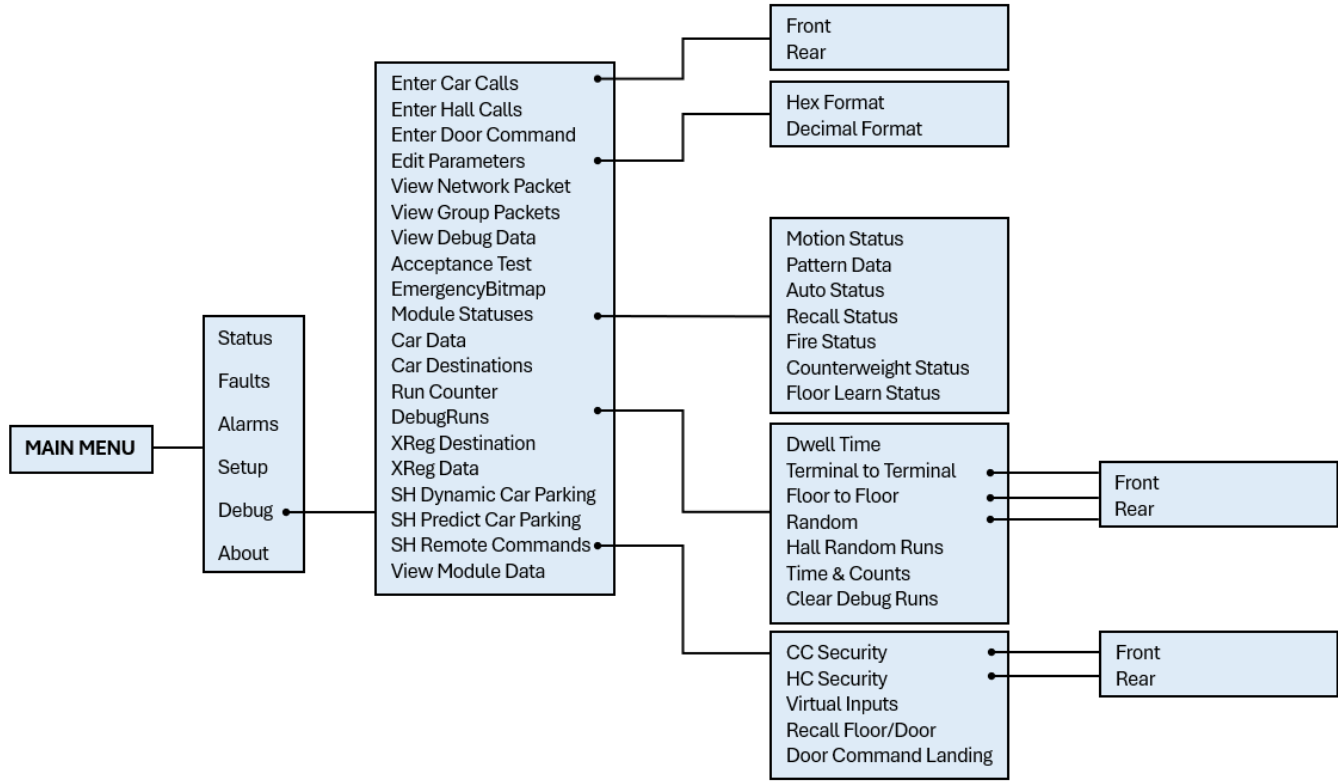

Figure 42: Debug Menus

The table below lists the Debug and About menu structures.

Table 25: Debug and About Menu Structures

Menu	Description
MAIN MENU	
Debug	Debug menu options
About	View job name and software version
Debug	
Enter Car Calls	Manually latch car calls. Calls entered here bypass security.
Enter Hall Calls	Enter hall calls to a specific landing and mask
Enter Door Command	Enter door commands
Edit Parameters	Edit parameters in hex or decimal
View Network Packet	Debug option to view network packets
View Group packets	Debug option to view group packets
View Debug Data	Debug option to view various controller data
Acceptance Test	Acceptance testing options
EmergencyBitmap	Emergency power debug option

Menu	Description
Module Statuses	Debug option to view module status
Car Data	View car data
Car Destination	View car destination data
Run Counter	View number of runs car completed
DebugRuns	Random run generator
XReg Destination	Cross registration destination data
XReg Data	Miscellaneous cross registration data
SH Dynamic Parking	Parking based on priority landings
SH Predict Parking	Parking assignment based on prior history
SH Remote Commands	Virtual commands to the controller
View Module Data	View various information associated to specific modules
Enter Car Calls	
Front	Generate front car calls
Rear	Generate rear car calls
Edit Parameters	
Hex Format	Edit parameters in Hex format
Decimal Format	Edit parameters in Decimal format
Module Statuses	
Motion Status	Motion sequence status
Pattern Data	View status of pattern
Auto Status	View status of auto operation
Recall Status	View status of car recall operation
Fire Status	View status of fire service operation
Counterweight Status	View status of counterweight derailment
Floor Learn Status	View status of floor learn operation
DebugRuns	
Dwell Time	Time between debug car calls for random call generator
Terminal to Terminal	Enables terminal to terminal runs
Floor to Floor	Enables floor to floor calls
Random	Generates random car calls
Hall Random Runs	Generates random hall calls
Time & Counts	Displays the elapsed time and number of trips when the car is on floor-to-floor, terminal-to-terminal, and random runs modes.
Clear Debug Runs	Clears any/all debug runs
Terminal to Terminal	
Front	Enables front door terminal to terminal runs
Rear	Enables rear door terminal to terminal runs
Random	
Front	Enables front door random calls

Menu	Description
Rear	Enables rear door random calls
SH Remote Commands	
CC Security	Allows for remote secure car calls
HH Security	Allows for remote secure hall call
Virtual Inputs	Allows for a variety of inputs set remotely
Recall/Floor Door	Sets recall floor and door that opens when remote recall to floor input is asserted
Door Command Landing	Sets door command to a designated landing
CC Security	
Front	Enables front door security car calls
Rear	Enables rear door security car calls
HC Security	
Front	Enables front door security hall calls
Rear	Enables rear door security hall calls

4 High-Level Navigation Menu Structure

The high-level navigation displays a hierarchy of menus used to setup, troubleshoot, and check the status of the controller.

NOTE: The menu options displayed for the high-level navigation do not show a '*' for the selected menu.

4.1 Main Menu

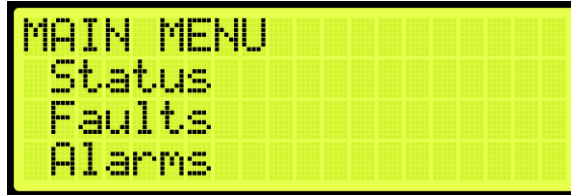

Figure 43: MAIN MENU - Status, Faults, Alarms

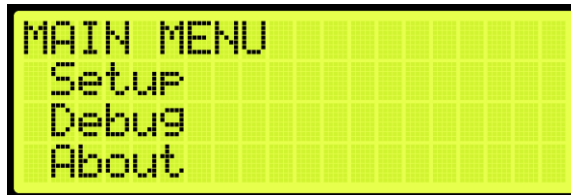

Figure 44: MAIN MENU – Setup, Debug, About

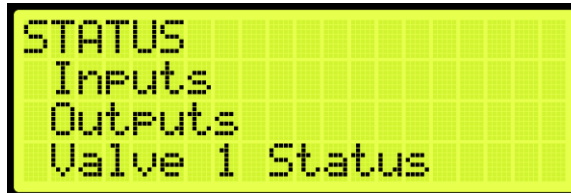

Figure 45: STATUS Menu – Inputs, Outputs, Valve 1 Status

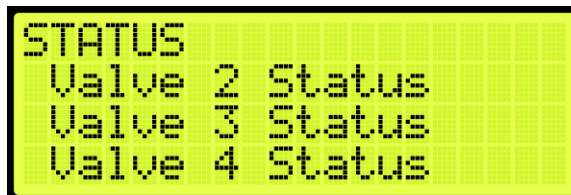

Figure 46: STATUS Menu – Valve 2 Status, Valve 3 Status, Valve 4 Status

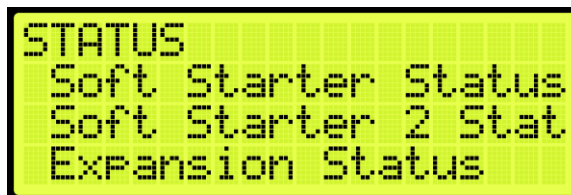

Figure 47: STATUS Menu – Soft Starter Status, Soft Starter 2 Status, Expansion Status

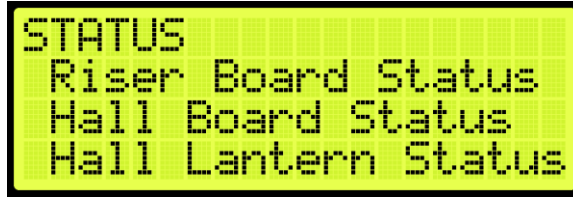

Figure 48: STATUS Menu – Riser Board Status, Hall Board Status, Hall Lantern Status



Figure 49: STATUS Menu – Hall Security Status



Figure 50: STATUS Menu – Hall Call Status, DAD Status, Clock

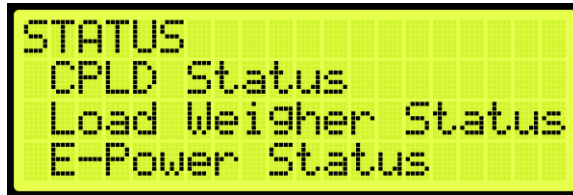

Figure 51: STATUS Menu – CPLD Status, Load Weigher Status, E-Power Status

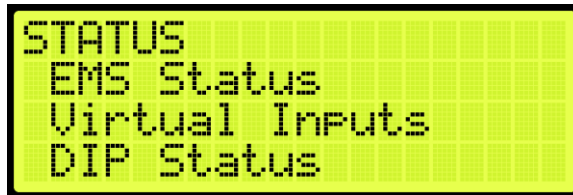

Figure 52: STATUS Menu – EMS Status, Virtual Input, DIP Status

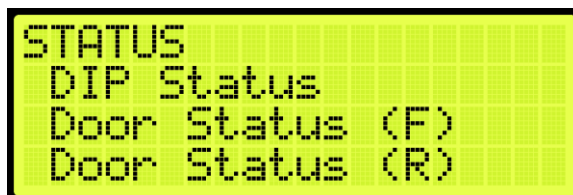

Figure 53: STATUS Menu – Door Status (F) and Door Status (R)

4.2 Faults

The FAULTS menu displays a list of active and inactive faults.

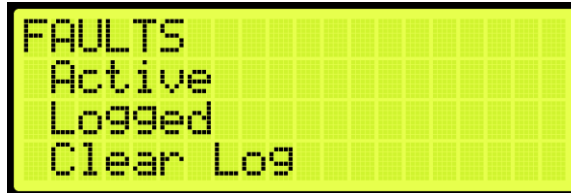

Figure 54: FAULTS Menu – Active, Logged, Clear Log

4.3 Alarms

The ALARMS menu displays a list of active and inactive alarms.

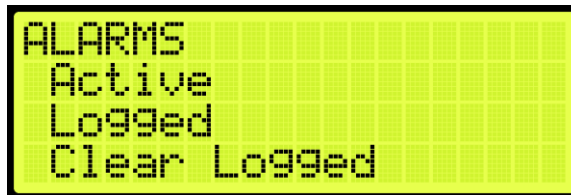

Figure 55: ALARMS Menu – Active, Logged, Clear Log

4.4 Setup

The SETUP menu consists of menus used for system configuration.



Figure 56: SETUP MENU – Setup I/O, Safety, Run Timers



Figure 57: SETUP MENU – Door Setup, Speeds, Floors



Figure 58: SETUP MENU – Hoistway Access, Fire

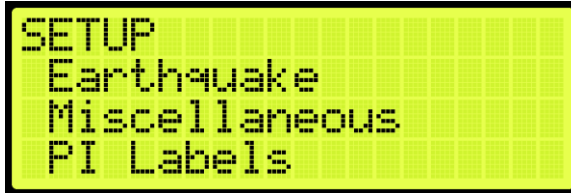

Figure 59: SETUP MENU – Earthquake, Miscellaneous, PI Labels

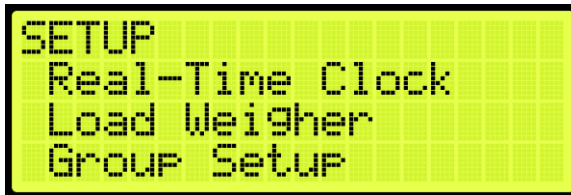

Figure 60: SETUP MENU –Real-Time Clock, Load Weigher, Group Setup



Figure 61: SETUP MENU – Group Setup, Flood, EMS

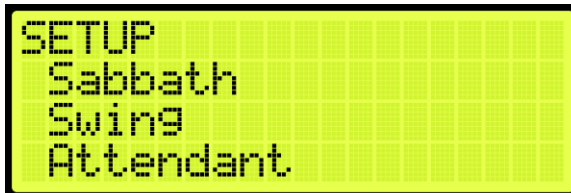

Figure 62: SETUP MENU – Sabbath, Swing, Attendant



Figure 63: SETUP MENU – E-Power, Hydro, Access Code

4.5 Debug

The DEBUG menu consists of menus used for testing the system.

```
DEBUG
Enter Car Calls
Enter Hall Calls
Enter Door Command
```

Figure 64: DEBUG Menu – Enter Car Calls, Enter Hall Calls, Enter Door Command

```
DEBUG
Edit Parameters
View Network Packet
View Group Packets
```

Figure 65: DEBUG Menu – Edit Parameters, View Network Packet, View Group Packets

```
DEBUG
View Debug Data
Acceptance Test
EmergencyBitmap
```

Figure 66: DEBUG Menu – View Debug Data, Acceptance Test, EmergencyBitmap

```
DEBUG
Module Statuses
Car Data
Car Destinations
```

Figure 67: DEBUG Menu – Module Statuses, Car Data, Car Destinations

```
DEBUG
Car Destinations
Run Counter
DebugRuns
```

Figure 68: DEBUG Menu –Run Counter, DebugRuns

```
DEBUG
XREG Destination
XREG Data
SH Dynam Car Parkin
```

Figure 69: DEBUG Menu – XReg Destination, XReg Data, SH Dynamic Car Parking

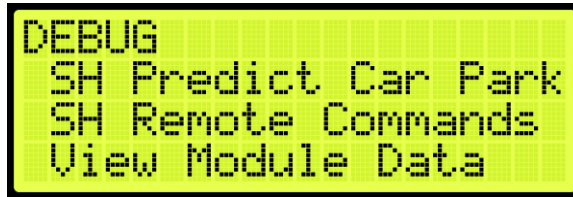

Figure 70: DEBUG Menu – SH Predictive Car Parking SH Remote Commands and View Module Data

5 Parameters

Parameters are configured per job. Users can edit parameters either as binary, decimal, or hexadecimal format. If editing for binary, the binary option is part of the hexadecimal and decimal format. The binary parameter can be set to either ON or OFF.

The following procedure describes how to set the parameters.

1. Navigate to MAIN MENU | DEBUG | EDIT PARAMETERS (See Figure 65).
2. From the PARAMETER EDIT menu, scroll and select Hexadecimal or Decimal Format.



Figure 71: PARAMETER EDIT Menu – Hexadecimal or Decimal Format

3. From the EDIT menu, edit the address.

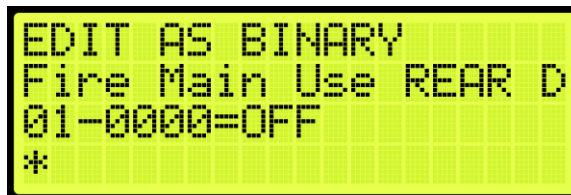

Figure 72: EDIT AS BINARY Menu

NOTE: the EDIT AS BINARY Menu will be visible only when navigating through the 1-bit parameters.



Figure 73: EDIT AS HEXADECIMAL Menu

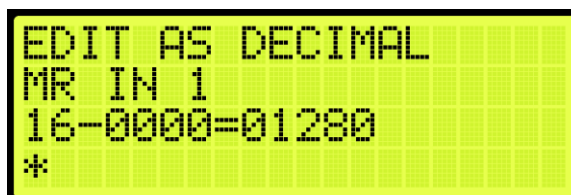

Figure 74: EDIT AS DECIMAL Menu

4. Scroll right and press Save.

6 Construction Mode

6.1 Main Power Setup

The following procedure describes how to setup the Main Power.

1. Verify that the main disconnect switch is in the OFF position.
2. Verify all green push breakers are in the up position (OFF).



Figure 75: Breakers in the OFF Position

3. Verify the L1/L2 breaker is in the OFF position.
 - Green = OFF
 - Red = ON



Figure 76: L1/L2 Breaker

4. Connect main line power L1/L2/L3 to soft starter and motor.
5. Connect the ground wire to the green terminal screw on the soft starter mounting plate.

6. Connect the Valve board to the soft starter.

6.2 Start Construction Mode

All connections regarding safety are functional during Construction Mode.

Follow these instructions to set up to Construction Mode:

1. Jump all PIT, BUF, TFL to H120.
2. Jump LFT, LFM, LFB to L120 (Front)
3. Jump LRT, LRM, LRB to L120 (Rear)
4. Wire temporary run box according to Figure 77 for construction mode.
5. Select inspection switch on MR (SR-3032).
6. On the User Interface (UI):
 - i. Navigate to SET UP.
 - ii. Go to MISCELLANEOUS.
 - iii. Go to ENABLE CONST. BOX.
 - iv. Select ON.
 - v. Click on SAVE.

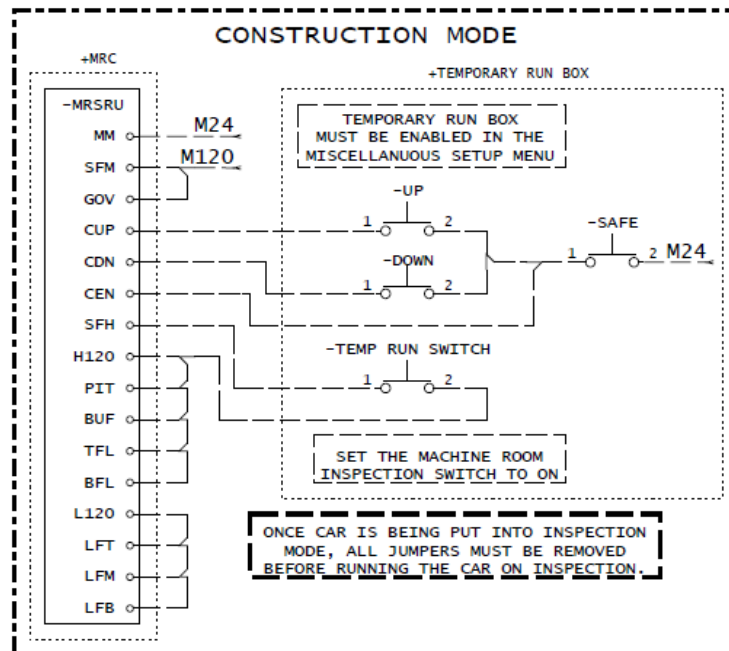

Figure 77: Construction Mode Connections on HEV Controller

6.3 Soft Starter Setup

The soft starter is connected to the Valve board and the motor.

The three common I/O to the soft starter are:

- **Neutral:** the Neutral signal comes through the fault contactor to the soft starter to control the torque to the motor.
- **SM (Start Motor):** the SM signal comes from the Valve board to enable the soft starter to activate. The soft starter then provides a ramp up voltage to the motor.
- **SS Fault:** the soft start outputs a fault notification to the MR board when a fault occurs within the soft starter.

See *Hydro:Evolved* sheet 8 *Soft Starter* for wiring information.

7 Inspection Mode

Prior to running on inspection operation, all connections need to be made from the MR to the CT and CT to COP. See the *Hydro:Evolved Controller sheet 5 MR Board*, sheet 13 *Traveler/Safety String*, sheet 13 *CT board* and sheet 17 *COP Board* for wiring information.

7.1 Standard Modes of Inspection

Machine Room inspection is activated using the MR INSPECTION switch. The car can be moved from the UP and DOWN buttons located on the MR board. This form of inspection is overridden by the Hoistway Access and CT Inspection.

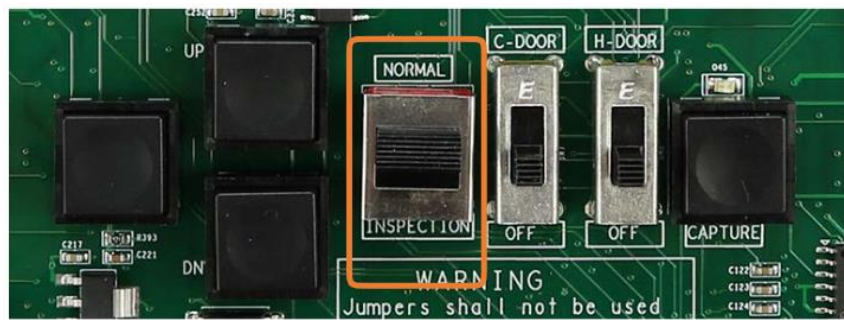

Figure 78: MR INSPECTION Switch

CT Inspection is the highest mode of inspection and overrides all other forms of inspection. The car is placed on CT inspection using the INSPECTION switch located on the top of the car run box. A run can be asserted by using the enable *and* UP or DOWN commands from the run box.



Figure 79: Car Run Box

Hoistway Access Inspection is a form of inspection used to run the car with the doors open at a terminal landing. The Hoistway Access inputs are discretely wired back to each controller’s MR board. To use this form of inspection, the car must be at a terminal landing.

7.2 Inspection Run Options and Adjustments

The controller uses pattern generation to conduct all runs, including inspection runs. This means that there is an inherent ramp up to the inspection speed when initiating the run and a ramp back to zero speed when the run is released. The inspection run options are configurable. If the speed is increased, the car travels faster. If the speed is decreased, the car runs slower. The controller will fault if the speed feedback exceeds 150 FPM.

The adjustment range is from 0-150 FPM.

- Default = 50 FPM
- Unit of Measure = FPM

The following procedure describes how to verify the inspection speed of the car.

1. Navigate to MAIN MENU | SETUP | SPEEDS (See Figure 57).
2. From the SPEEDS menu, scroll and select Inspection Speed.

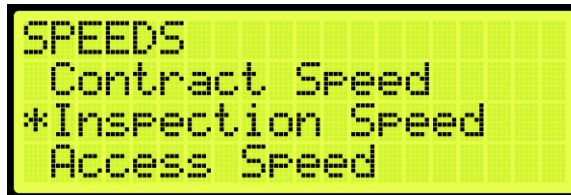

Figure 80: SPEEDS Menu – Inspection Speed

3. Verify the inspection speed. The value of the inspection speed can be set from 0 to 150 FPM. If the value is set > 150 FPM, the controller will fault until the parameter is adjusted to a value \leq 150 FPM. If the inspection speed is less than the contract speed, the car will move at low speed depending on how the leveling valves are set. If the inspection speed matches the contract speed the car will move with at high speed.



Figure 81: INSPECTION SPEED Menu

4. Scroll right and press Save.

8 Adjusting Run Timers

Start and end-run timers are used to maximize the quality of the run for each car. The run timers may need to be adjusted depending on the start and stop sequence.

SM1 Pick Delay: delays the time between activating the primary start motor output and activating a valve when the car is moving in the up direction.

If the SM1 Pick Delay is greater than required when the primary motor starts up, there may be no oil to pump into the valve. This will cause an initial jerking motion during startup.

If the SM1 Pick Delay is less than required when the primary motor starts up, the motor and valve activation may occur at the same time. This will cause a jerking motion due to the increased amount of oil within the pump.

The adjustment range is from: 0 – 12.75 seconds.

- Default = 50 ms
- Unit of Measure: ms

SM2 Pick Delay: delays the time between activating the secondary start motor output and primary start motor output. This delay is skipped if the secondary soft starter is not used.

If the SM2 Pick Delay is greater than required when the secondary motor starts up, the car can either start slowly or not at all. The secondary motor also draws more current.

If the SM2 Pick Delay is less than required when the secondary motor starts up, there may be an initial jerking motion at startup.

The adjustment range is from: 0 – 12.75 seconds.

- Default = 50 ms
- Unit of Measure: ms

Delta Pick Delay: delays the time between activating the delta output and activating the valve outputs.

The adjustment range is from: 0 – 12.75 seconds.

Pump Off Delay: delays the time between deactivating the valves and turning off the start pump motor outputs.

If the pump off delay is greater than required, the motor would be on even when there is no oil to pump.

If the pump off delay is less than required or set to zero, the motor would turn off and there will be residual oil left in the pump.

The adjustment range is from: 0 – 12.75 seconds.

- Default = 50 ms
- Unit of Measure: ms

Safe Drop Delay: -delays the time between deactivating the pump motor and the SAFE output from the MR board.

The adjustment range is from: 0 – 12.75 seconds.

- Default: 50 ms
- Unit of Measure: ms

The following procedure describes how to adjust the Run Timers.

1. Navigate to MAIN MENU | SETUP | Run Timers (See Figure 56).
2. Adjusting start of run timers or end of run timers:



Figure 82: TIMERS Menu

- i. If adjusting start of run timers, from the TIMERS menu, click Start Timers and go to step 3.
 - ii. If adjusting end of run timers, from the TIMERS menu, click Stop Timers and go to step 4.
3. If adjusting SAFE Pick Delay, SM Pick Delay, or Delta Pick Delay, select the timer being adjusted and adjust the value. Go to step 5.

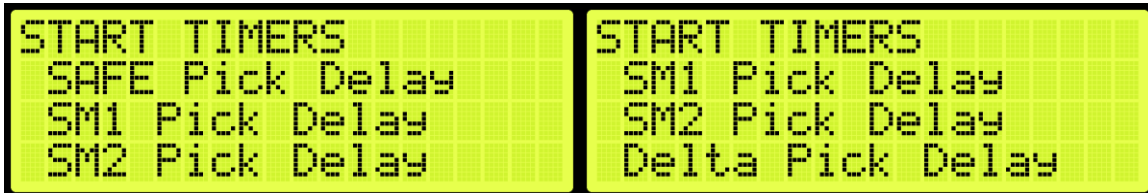

Figure 83: START TIMERS Menu

4. If adjusting Pump Off Delay or SAFE DROP Delay, scroll and select the timer being adjusted and adjust the value.



Figure 84: STOP TIMERS Menu

5. Scroll right and press Save.

9 SmartPositioning Landing System

The SmartPositioning Landing System tracks elevator speed and position with high precision and superior reliability. It incorporates a contact-less dual infrared sensor system, QR Code tape and a SmartClip consolidated mounting system that reduces installation time and maintenance. The system increases performance and reliability. See Figure 4 and Figure 5 for the SmartPositioning Landing System.

The SmartPositioning Landing System consists of:

- Coded Tape.
- Sensor Array Assembly.
- Tape Clip Assembly.
- Top Tape Mount Assembly.
- Bottom Tape Mount Assembly.
- Emergency Tape Break Switch Assembly.

9.1 Coded Tape

The tape is a special coded tape that provides the absolute positioning feedback to the CEDES camera.



Figure 85: Coded Tape

WARNING

THE TAPE EDGE IS SHARP. CUT-PROOF GLOVES MUST BE WORN WHILE HANDLING THE TAPE.



Figure 86: Gloves Required

The following procedure describes how to install the tape:

1. Open the tape box at the top corner, being mindful of the sharp ends or edges, and pull out the tape as needed.

CAUTION: do not pull out too much tape from the box as excessive bending can occur and damage the tape.

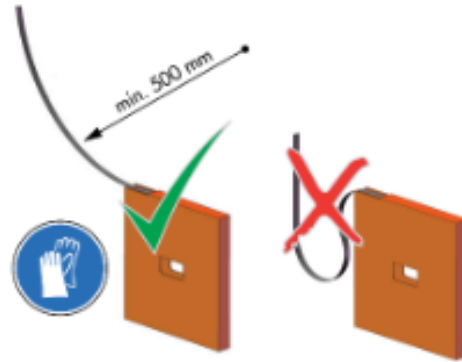

Figure 87: Tape Minimum Bend Radius

2. Serpentine and secure the tape through the bracket then zip tie loose end.

NOTE: verify the words Left are on the left side of the tape with the barcode facing out towards the camera.

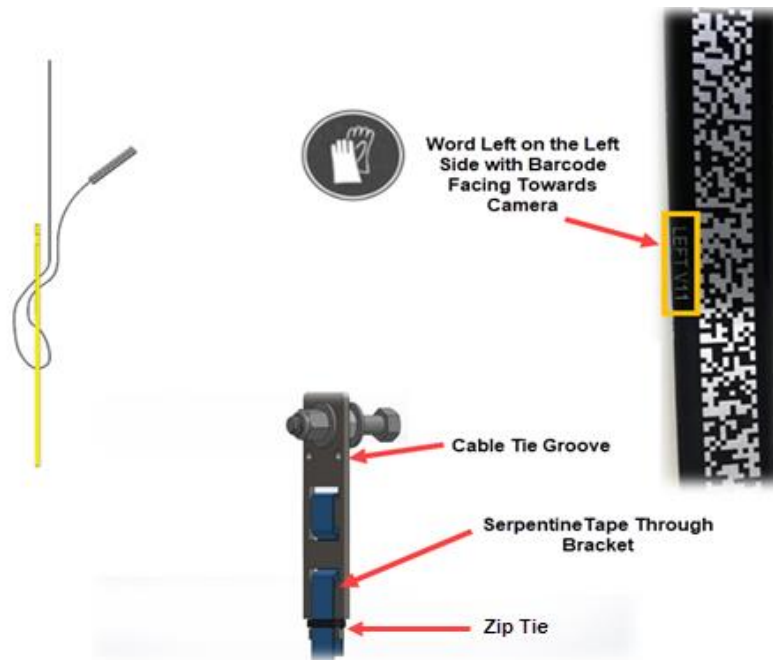

Figure 88: Routing Tape

9.2 Sensor Assembly Installation

The following procedure describes how to secure the Sensor Assembly to the Car Top Frame C-Channel.

NOTE: exact positioning and lengths of the Unistrut can be adjusted as needed if the Sensor Array is positioned as shown in Figure 89.

1. Cut the lengths of Unistrut as follows:
 - Two 18"

- One 24"
2. Bolt the two 18" lengths of Unistrut to the C-Channel.

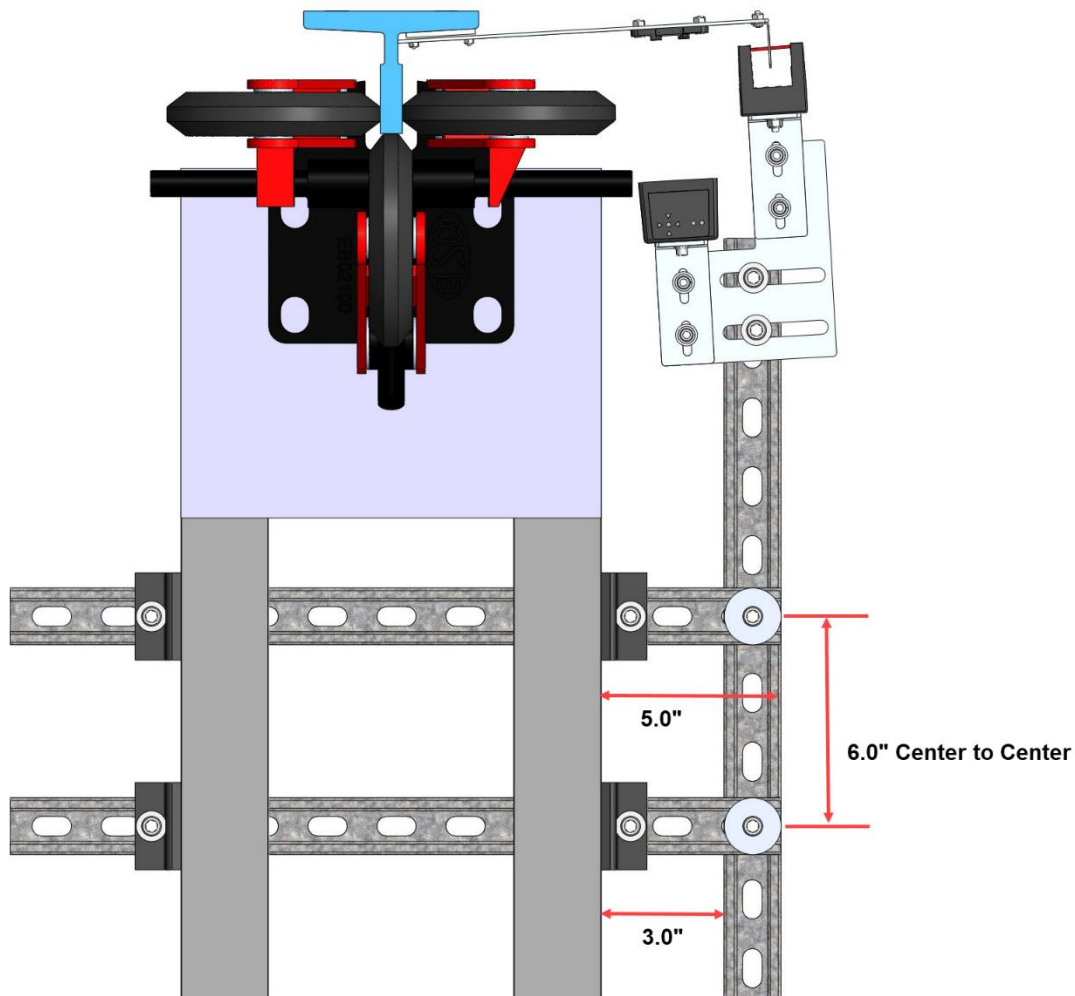

Figure 89: Unistrut Installation

3. Bolt the 24" length of Unistrut to the two 18" lengths of Unistrut (See Figure 89).
NOTE: the 24" length may be bolted to the top of the two 18" lengths if applicable.
4. Temporarily affix a Tape Clip Assembly on the guide rail to use as an alignment for the Sensor Array Assembly.

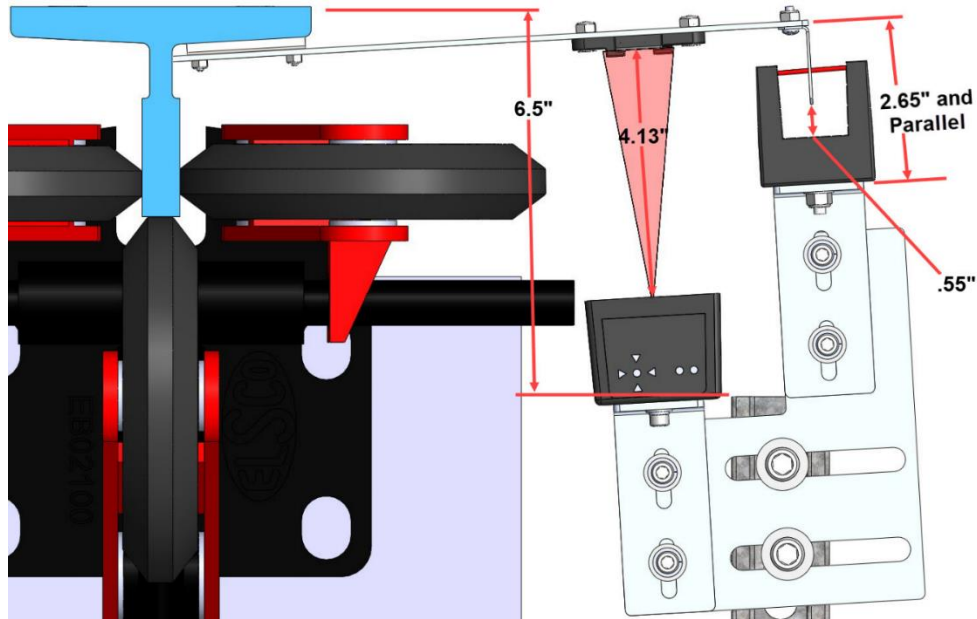

Figure 90: Sensor Array Assembly Positioning

5. Set the end of the 24" length Unistrut at 6.5" from the rear surface of the guide rail (See Figure 90).
6. Loosely bolt the Sensor Array Assembly onto the 24" length of Unistrut with the Door Zone Blade centered horizontally in the GLS Reader and parallel to the Tape Clip Assembly (See Figure 90).
7. Position the Sensor Array Assembly according to the distances shown in then tighten all bolts.

NOTE: the Optical Sensor Mount bolts may be loosened if needed to adjust the position of the sensor.

After the Sensor Array Assembly positioning has been completed, the Sensor Array Assembly needs to be fine-tuned for proper operation (See Section 9.8 Fine Tune).

9.3 Upper Tape Mount Assembly

The Upper and Lower Tape Mount Assemblies are located as shown.

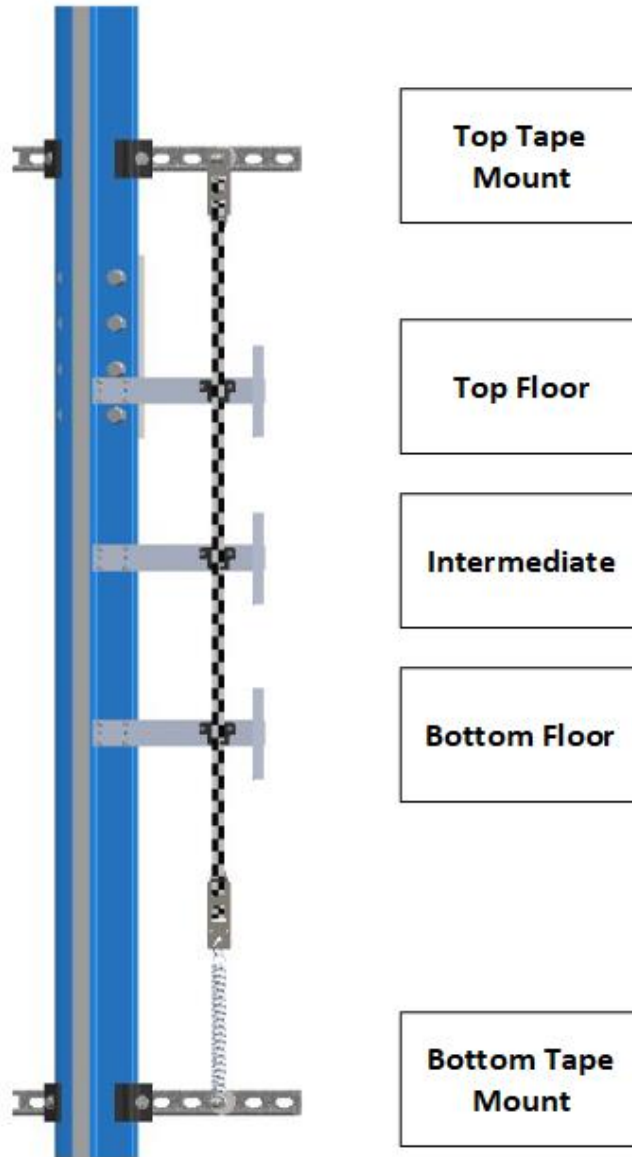

Figure 91: Location of Tape Mount Assemblies

The following procedure describes how to install the Upper Tape Mount Assembly.

1. Affix an 18” length of Unistrut to the top of the guide rail.

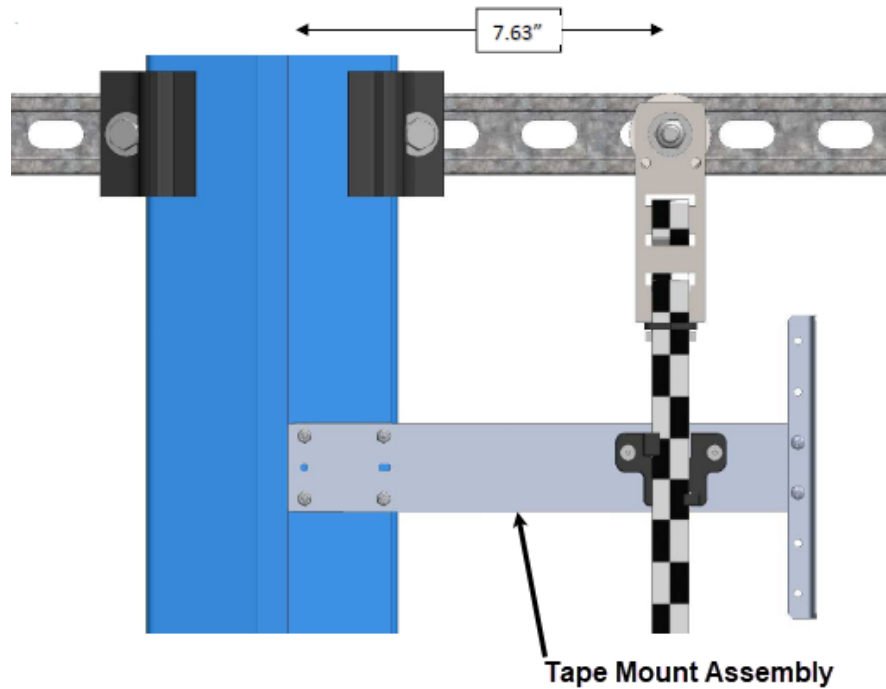

Figure 92: Upper Tape Unistrut Installation

2. Loosely attach the hardware to the Upper Tape Mount Assembly.

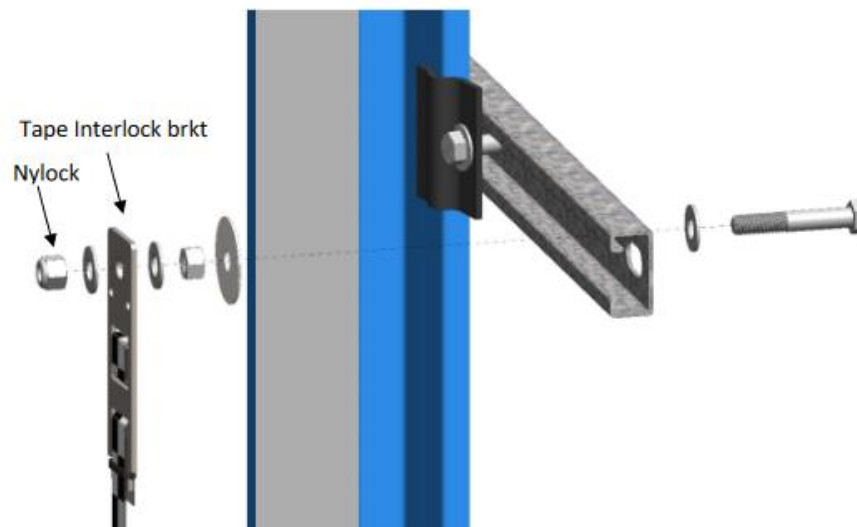

Figure 93: Hardware

3. Position the Upper Tape Mount assembly 7.63" from the wheel surface of the guide rail to the center of the 3/8" bolt (See Figure 92).
4. Temporarily affix a Tape Clip Assembly to the guide rail and onto the tape to verify location.
5. Tighten the first hex nut to secure the assembly in place.

- Thread the Nylock nut on the bolt until there is a 0.2" gap between the two flat washers that are on either side of the Tape Interlock bracket. This gap is required to relieve twist in the tape.

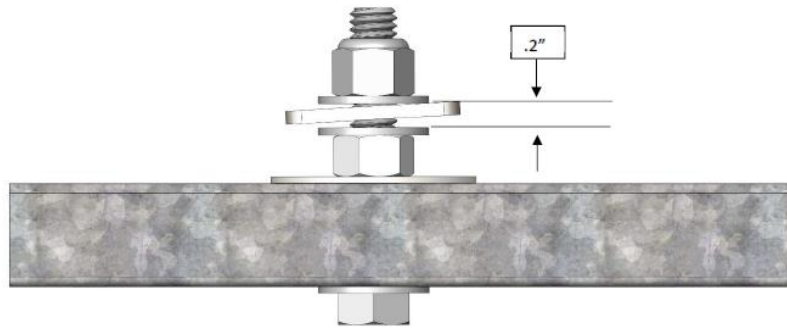

Figure 94: Gap Verification

9.4 Tape Clip Assembly

As you descend, unspool the tape, install the Tape Clip Assemblies and set the door zones.

The Tape Clip Assembly includes:

- Tape guide clip.
- Door zone blade.
- Mounting magnets (preassembled).

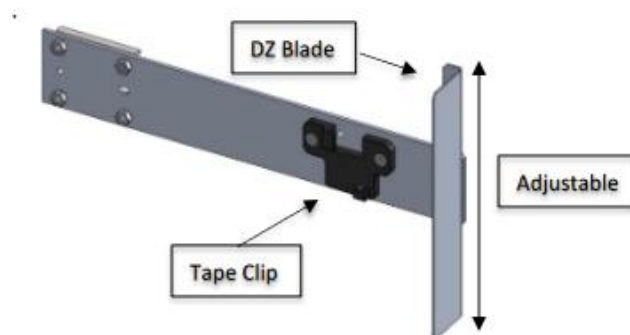

Figure 95: Tape Clip Assembly

NOTE: in applications where there is 15 ft of distance between door zones, an extra bracket needs to be placed between those door zones. The bracket will only contain the tape clip and NOT the DZ blade. This will minimize tape twisting caused by long distances between the door zones. These extra tape clip brackets will be provided as needed.

The following procedure describes how to install the Tape Clip Assembly.

1. Bring the car to floor level.
2. Wipe the rail clean where the Tape Clip Assembly is being attached.

3. Holding the Tape Clip Assembly with one hand and the tape with the other, rotate the tape into the tape clip.

CAUTION: do not twist or bend the tape as this may damage the tape.



Figure 96: Tape Clip Insertion

4. Place the Tape Clip Assembly onto the guide rail with the edge flush to the rail.

CAUTION: there are strong magnets. Do not remove the bracket from the rail by pulling the bracket from the far end as this may bend the bracket.

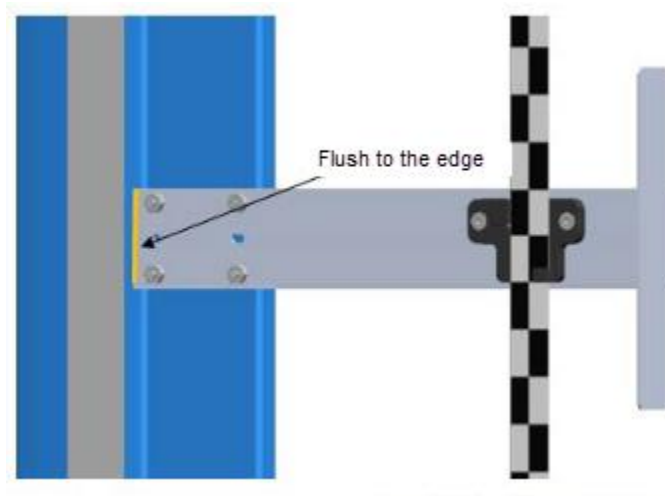

Figure 97: Tape Clip Assembly Alignment

5. Verify that the DZ blade is vertically centered with the GLS Reader optical axis.

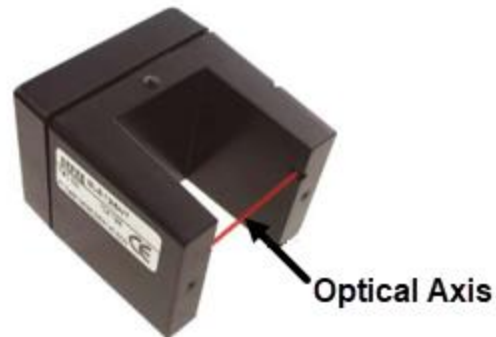

Figure 98: Optical Axis

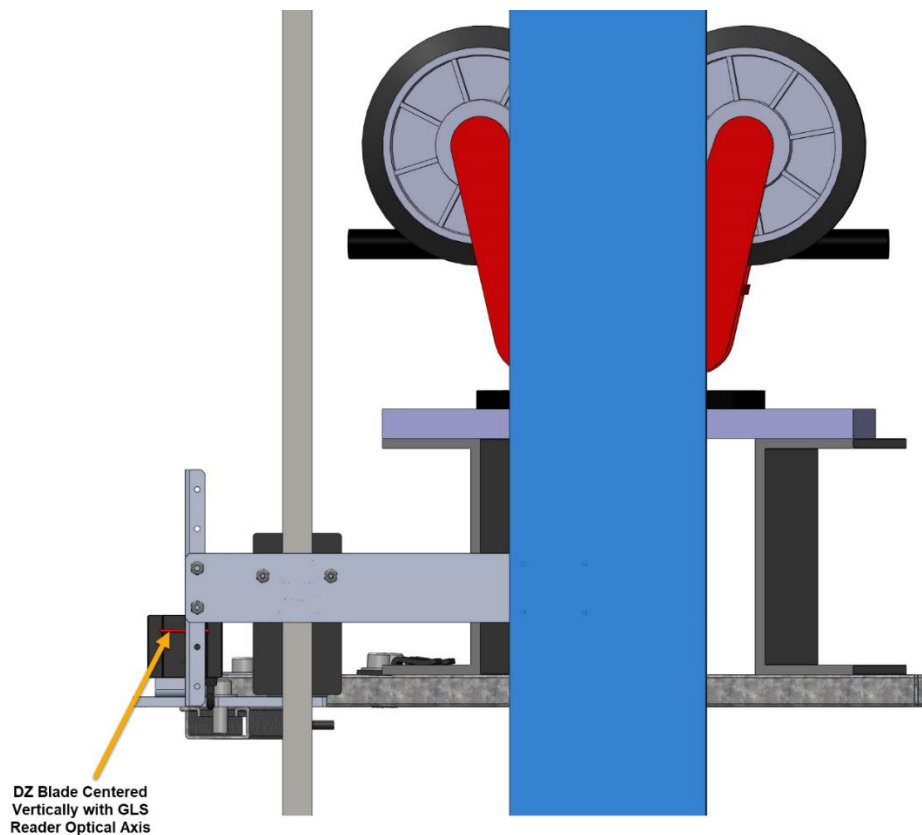

Figure 99: Tape Clip Assembly Placement (Rear View)

6. Are there any bolts or obstructions preventing the Tape Clip Assembly to be placed where needed?
 - i. If there are bolts or other obstructions, remove the two screws, washers and nuts securing the DZ blade and adjust the blade up or down. Go to step 7.
 - ii. If there are no obstructions, go to step 9.
7. Has the Tape Clip Assembly been placed as needed after the DZ blade has been moved up and down?

- i. If there are still obstructions, an extension arm is required. Go to step 8.
 - ii. If there are no obstructions, go to step 9.
8. Install extension arm as follows:
- Remove the DZ blade from the Tape Clip Assembly.
 - Install the door zone extension arm using the same screws, nuts, and washers (See Figure 100).
 - Using two more screws, nuts and washers provided in the install kit, mount the DZ blade to the DZ extension arm at the desired location.

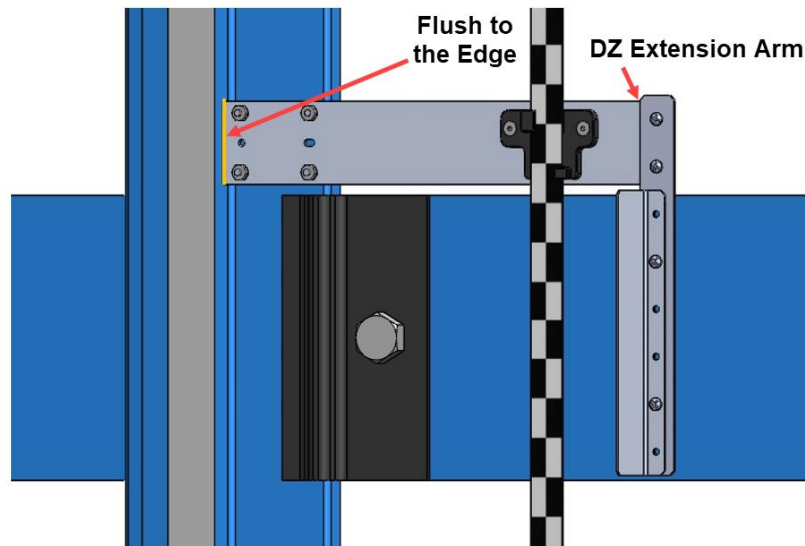

Figure 100: Tape Clip Assembly Alignment

9. Continue down the hoistway, placing the Tape Clip Assembly at each landing.

9.5 Lower Tape Mount Assembly

See Figure 91 for the location of the Lower Tape Mount Assembly.

The following procedure describes how to install the Lower Tape Mount Assembly.

1. Affix an 18" length of Unistrut to the bottom of the guide rail.

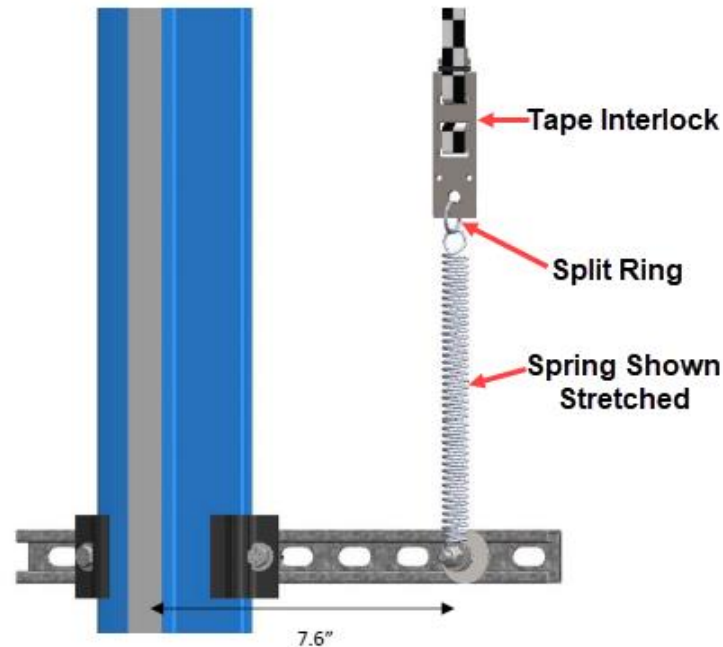

Figure 101: Lower Tape Mount Assembly

2. Loosely attach the hardware to the Lower Tape Mount Assembly.

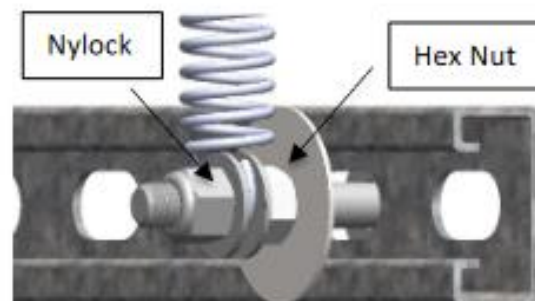

Figure 102: Hardware to Lower Tape Mount Assembly

3. Position the Lower Tape Mount Assembly 7.6" from the surface of the guide rail to the center of the 3/8" bolt (See Figure 101).
4. Tighten the first hex nut to secure the Lower Tape Mount Assembly in place.
5. Thread the Nylock nut onto the bolt until the two flat washers located on each side of the spring are just touching the spring loop. This nut does not need to be tightened.
6. Connect the spring to the tape interlock bracket using the split ring (See Figure 101).
7. Adjust the spring tension by raising or lowering the Unistrut mounting point so that the spring is stretched to approximately 3".

9.6 Sensor Array Assembly

The Sensor Array Assembly contains the CEDES Optical Sensor, CEDES Exact Position GLS Reader, mounting brackets, and associated hardware. The sensors can be oriented differently as long as the corresponding tape and blades are aligned correctly.

After assembly is complete, connect the CEDES Optical Sensor and the CEDES Exact Position GLS Reader to the CT board and secure cabling.

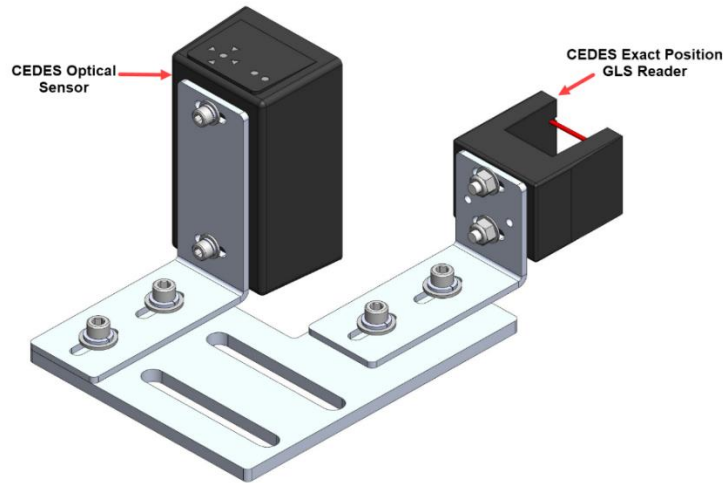

Figure 103: Sensor Array Assembly

The Cedes Optical Sensor and Reader can be connected to either side of the sensor base plate depending upon which side the Sensor Array Assembly is connected to the C-Channel See Figure 4 and Figure 5.

The following procedure describes how to connect the Optical Sensor and Reader to either side of the sensor base plate.

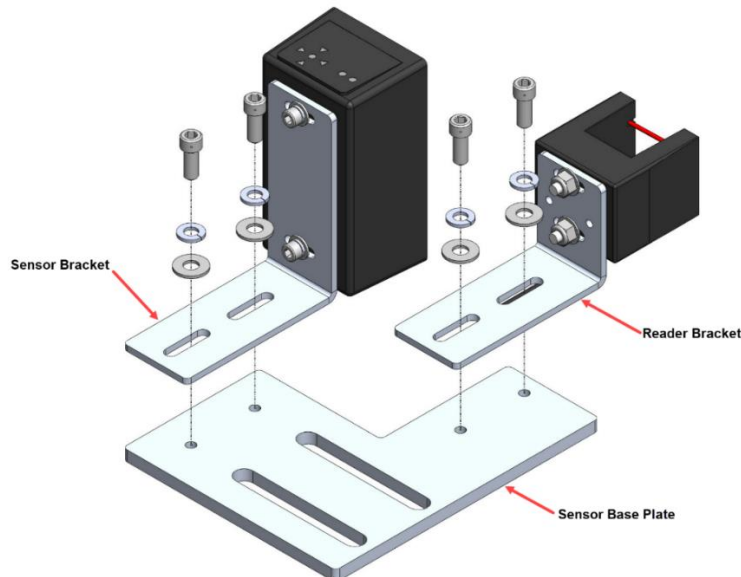

Figure 104: Sensor Array Assembly (Right Side)

1. Remove screws, lock washers, and washers securing the sensor and reader brackets to the sensor base plate.
2. Remove both sensor and reader brackets from the sensor base plate.
3. Flip the sensor base plate.
4. Place the sensor and reader brackets back onto the sensor base plate and secure.

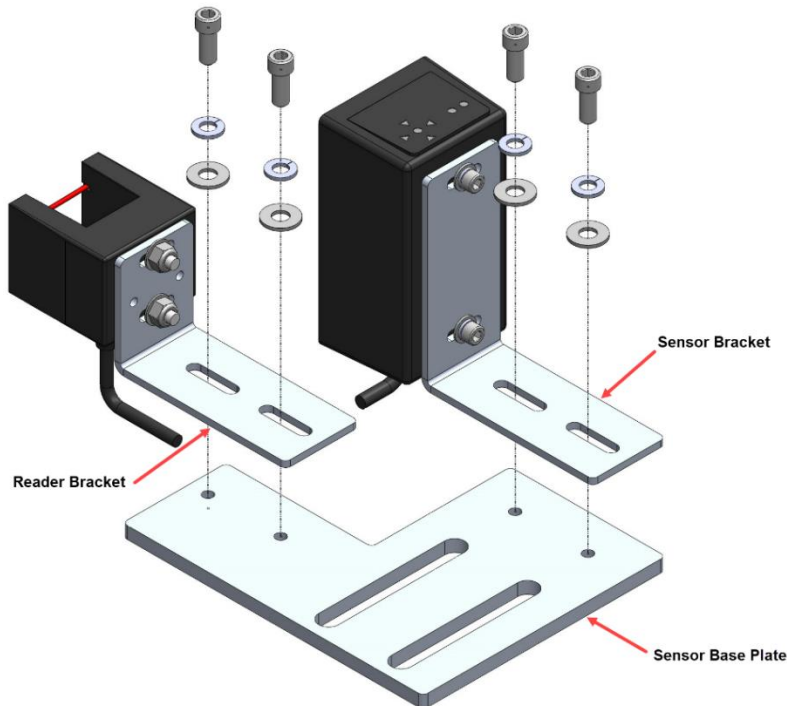

Figure 105: Sensor Array Assembly (Left Side)

A Dual Sensor Array Assembly can be installed if applicable.

NOTE (Short Floor!): In cases where there is a short floor distance (6 inches or less) between the front and rear openings, a secondary door zone sensor should be installed to the other side of the primary door zone sensor.

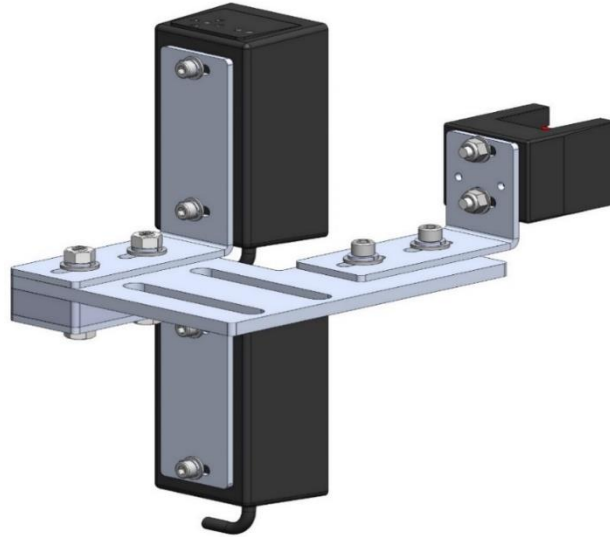

Figure 106: Dual Sensor Array Assembly

The following procedure describes how to connect the Optical Sensor and Reader to either side of the sensor base plate used on a Dual Sensor Array Assembly.

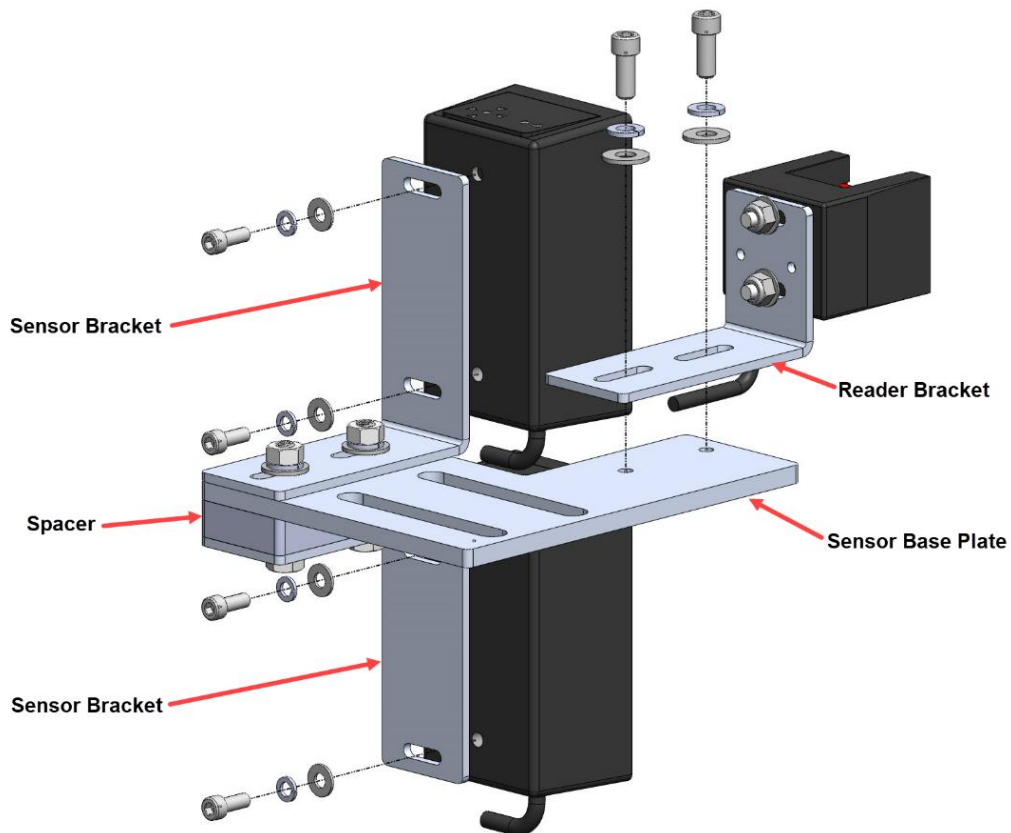

Figure 107: Dual Sensor Array Assembly (Right Side)

1. Remove screws, lock washers, and washers securing both optical sensors to the sensor brackets and remove optical sensors.
2. Remove screws, lock washers, and washers securing the reader bracket to the bottom sensor base plate and remove reader bracket.

NOTE: do not remove the reader from the reader bracket.

3. Flip the sensor base plate. The spacer is secured to the top of the sensor base plate.
4. Place both optical sensors back onto the sensor brackets with the optical sensor cables facing down and secure.
5. Place the reader bracket back onto the sensor base plate and secure.

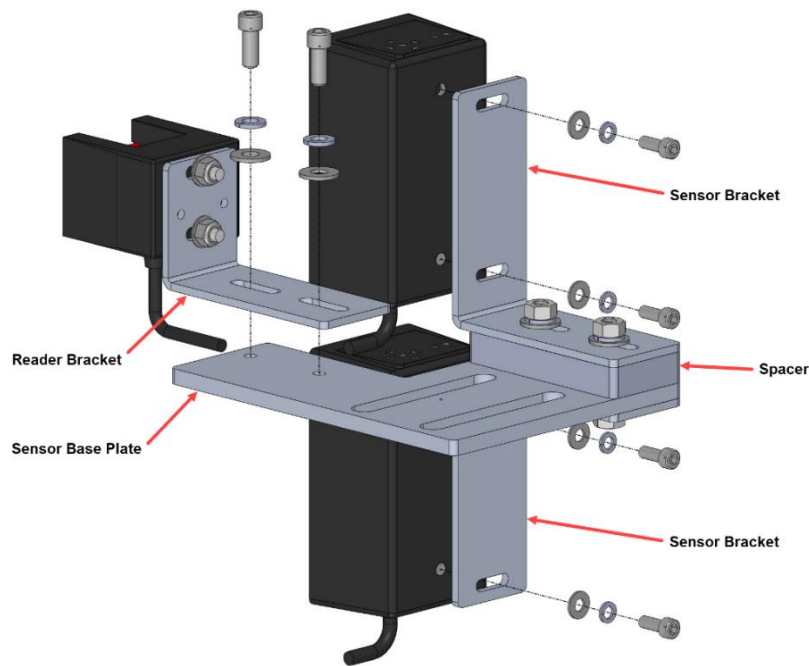

Figure 108: Dual Sensor Array Assembly (Left Side)

9.7 Emergency Tape Break (ETB) Switch Assembly

The ETB Switch Assembly is optional.

The ETB switch is installed in the safety string in **series** with the Buffer switch.

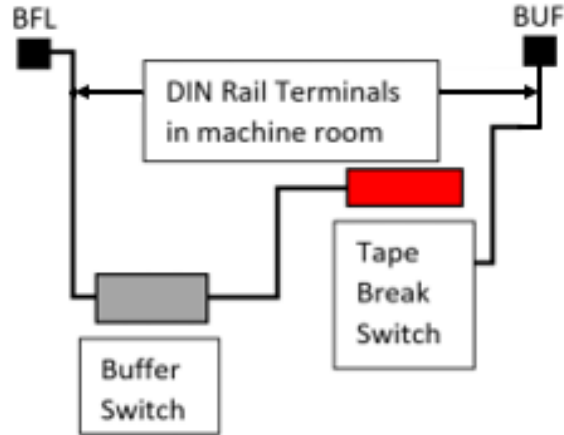

Figure 109: Emergency Tape Break Switch in Series with Buffer Switch

There is slack in the wire when the tape tension spring is fully extended. This slack allows for tape and/or building movement. If the tape breaks, the tension spring retracts and pulls the cable attachment out of the ETB switch, opening the safety string. Verify that the cable length allows the tab to pull out of the ETB switch when the spring is retracted (See Figure 111).

The following procedure describes how to install the ETB Switch Assembly.

1. Affix a 12” length of Unistrut to the bottom of the guide rail approximately 20” above the Lower Tape Mount Assembly Unistrut.

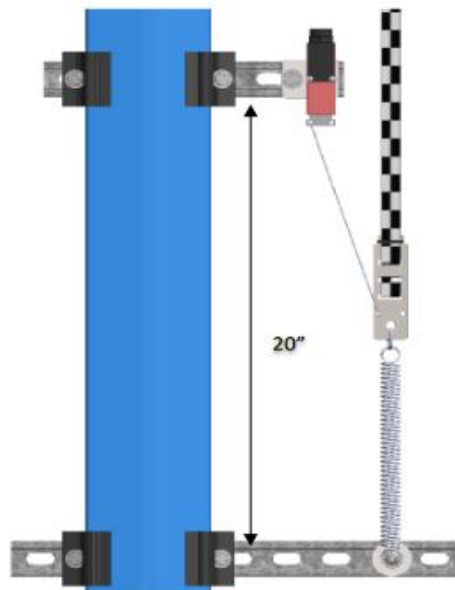

Figure 110: Unistrut to Lower Tape Mount Assembly

2. Attach bracket and ETB switch to the Unistrut.

3. Link the ETB switch to the tape interlock via the cable kit provided. Leave 1-2” for slack in the cable.

NOTE: the switch can be mounted vertically as well as by inserting a switch pull tab into the bottom end, pull should always face downward.

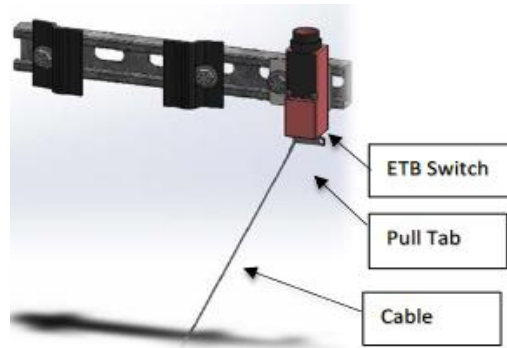

Figure 111: Emergency Tape Break Switch

9.8 Fine Tune

Prior to fine tune, verify the Sensor Array Assembly placement. The Sensor Array Assembly should be at a distance of 4.13” with a tolerance of ± 1 cm from the tape and parallel to the tape clip mounting brackets (See Figure 90).

The optical sensor and reader can move front and back, and side to side as applicable.

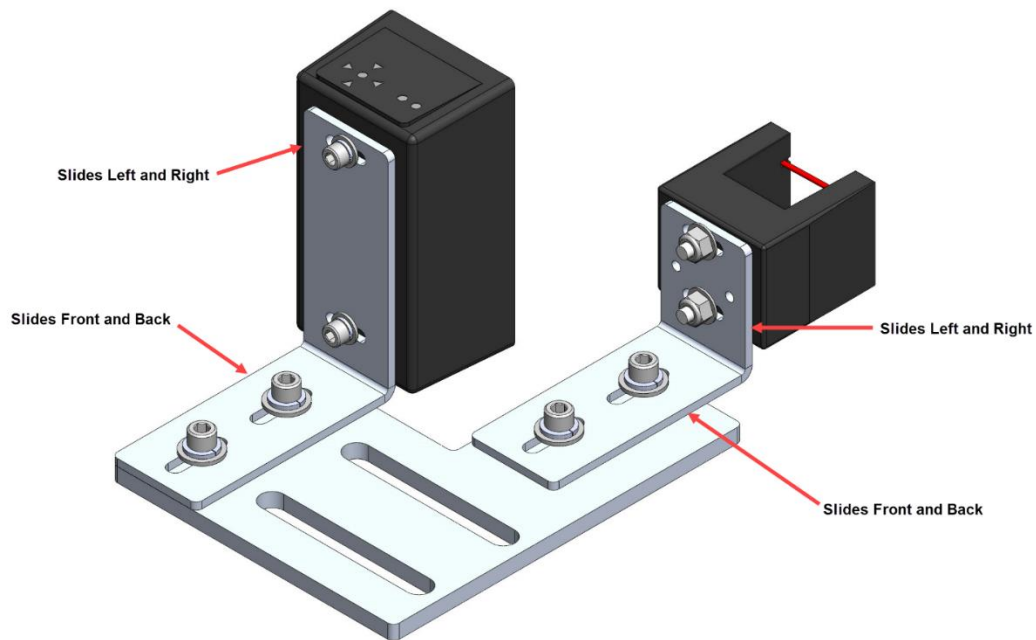

Figure 112: Sensor Array Assembly Adjustment

Power the APS camera via a RJ45 cable to the CT board so a red array can be seen on the tape to allow for alignment. If there is no red array on the tape, reset the power by disconnecting and reconnecting the RJ45 cable to the CT board CAT5 connector.

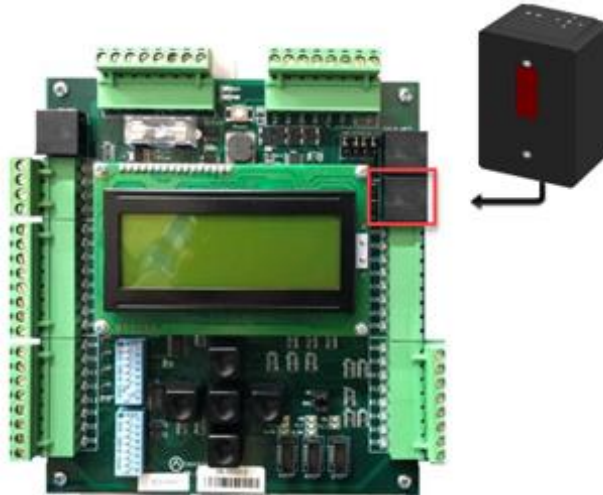

Figure 113: RJ45 Connection

Proceed on inspection up and down the hoistway and adjust each tape guide clip to the correct in-line position with respect to the Sensor Array Assembly.

The camera powers up when the CT station is powered up.

9.9 Alignment

Alignment and Position Status LEDs are located on top of the optical sensor. These LEDs are used to align the sensor to the tape.

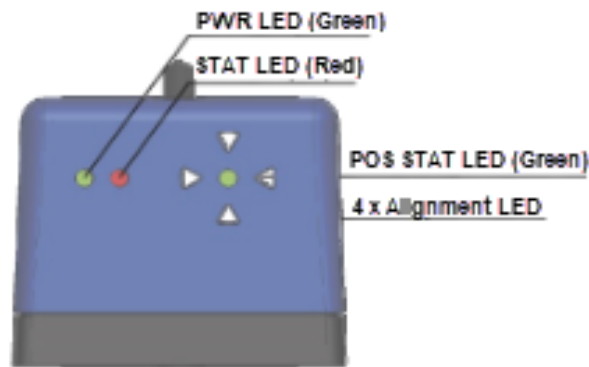

Figure 114: Optical Sensor LEDs

When the optical sensor needs to be aligned, the red arrow LEDs indicate which way to move the sensor. The following procedure describes how to align the optical sensor.

1. Loosen the two mounting bolts on sensor base plate or sensor bracket to adjust the sensor position, as required.

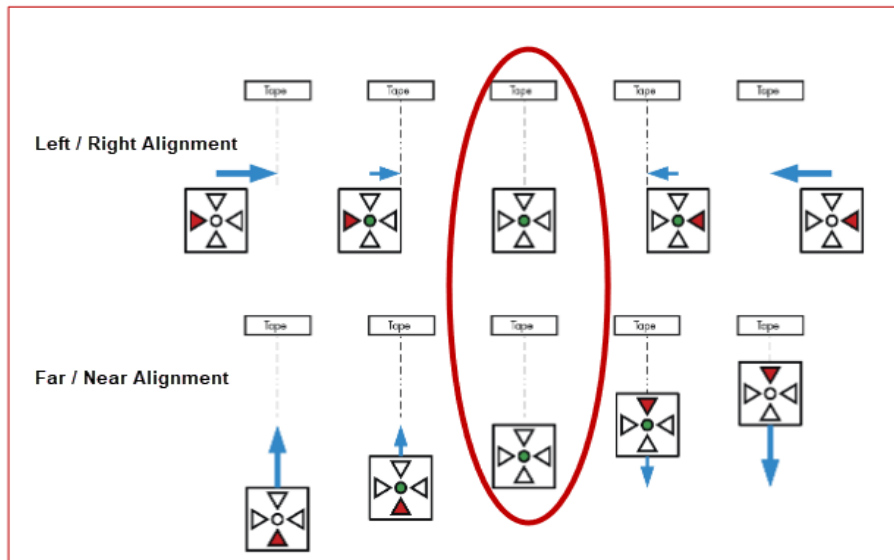

Figure 115: Alignment Arrows

2. Position the sensor according to the LEDs.
 - **Left / Right Alignment** – Using the direction arrows on top of the sensor, move the camera left or right until only the green POS STAT LED is on.
 - **Far / Near Alignment** – Using the directional arrows on top of the sensor, move the sensor closer to or further away from the tape until only the green POS STAT LED in on.
3. Once the sensor is aligned, tighten the two mounting bolts to the sensor base plate or sensor bracket as applicable.
4. Run the car on INSPECTION from terminal to terminal while watching the POS LED on top of the sensor.
5. Is the sensor aligned with the tape for the entire length of travel?
 - i. If the sensor is aligned, the process ends.
 - ii. If the sensor is not aligned, go to step 1.

NOTE: as the car runs up and down the hoistway, the red alignment arrow LEDs may flash on and off. This is OK if the center green LED stays on.

10 NEMA 4 Landing System

The Smartrise NEMA 4 Landing System tracks elevator position with high precision and superior reliability. The position is read from a coded magnetic strip that is guided through the position sensor. The position sensed from the magnetic strip is contact free. The door zone sensor is contact-less.

The advantage of using the Smartrise NEMA 4 Landing system is that there is no need for alignment or contrast monitoring.

The Smartrise NEMA 4 Landing System consists of:

- Proximity Sensor Assembly
- Coded Magnetic Tape
- Mounting Assembly
- Guide with Sensor Detector

10.1 Proximity Sensor Assembly

The magnetic proximity sensor in the Sensor Assembly reads the Smartrise Door Zone 6” magnetic strips. These sensors are non-latching. The magnets are installed next to the central protruding part of the guide rail.

NOTE (Short Floor!): In cases where there is a short floor distance (6 inches or less) between the front and rear openings, a secondary door zone sensor should be installed to the other side of the primary door zone sensor.

The Proximity Sensor Assembly consist of:

- Right Angle Mounting Bracket
- Cable
- Proximity Sensor

The following procedure describes how to assemble the Proximity Sensor Assembly.

1. Secure one nut onto the proximity sensor.
2. Slide the proximity sensor through the right-angle mounting bracket.
3. Secure the other nut onto the proximity sensor.



Figure 116: Proximity Sensor Assembly

When installing the Proximity Sensor Assembly, the distance of the sensor head to the magnet should be up to one inch.

Below is an example of how the Proximity Sensor Assembly can be mounted.

NOTE: the customer is responsible on how they want to mount the sensor.



Figure 117: Mounting Proximity Sensor Assembly (Example)

After the Sensor Assembly has been mounted, wire the Sensor Assembly to the Car Top. See the Controller +CTC sheet for wiring information.

10.2 Installation

The Safe Magnetic Absolute Sensor Assembly is installed using the mounting kit supplied by ELGO. See the *ELGO Operating Manual* on how to install the Assembly.

10.2.1 Mounting Magnetic Tape in the Hoistway

The magnetic tape is to be mounted to the top and bottom of the hoistway. Verify the magnetic tape has the magnetic side facing the sensor and has the arrows on the tape facing the top of the hoistway. See the *ELGO Operating Manual* on how to install the magnetic tape along the guide rail and spring.

10.2.2 Mounting the Sensor to the Car

The sensor must be mounted to the car. The sensor must be positioned upwards towards the top of the hoistway during installation. See the *ELGO Operating Manual* on how to mount the sensor.

Perform the following to attach the mounting bracket to the sensor.

1. Insert two sets of nuts into each groove of the sensor.
2. Line up the nuts to the holes within the placement of the bracket on the sensor.
3. Secure the bracket to the sensor using the two sets of screws and lock washers.

NOTE: the customer is responsible for the direction of the mounting bracket to the sensor and attaching the mounting bracket to the car.

10.2.3 Install Magnetic Tape Through Sensor

The sensor reads the positioning information from the magnetic tape. The magnetic tape is a special stainless steel tape that provides absolute positioning information.

WARNING

THE TAPE EDGE IS SHARP. CUT-PROOF GLOVES MUST BE WORN WHILE HANDLING THE TAPE.



Figure 118: Gloves Required

The tape consists of a steel side and a magnetized side. When installing the magnetic tape through the tape guide, the steel side of the tape must touch the guide.

There are two ways to install the magnetic tape through the tape guide.

1. Feed the tape from one end of the tape through the tape guide to the other end.

2. Removing the cotter pin.

- Remove the cotter pin from the channel.
- Remove tape guide.
- Place tape on sensor housing.
- Reinstall tape guide.
- Reinstall cotter pin.

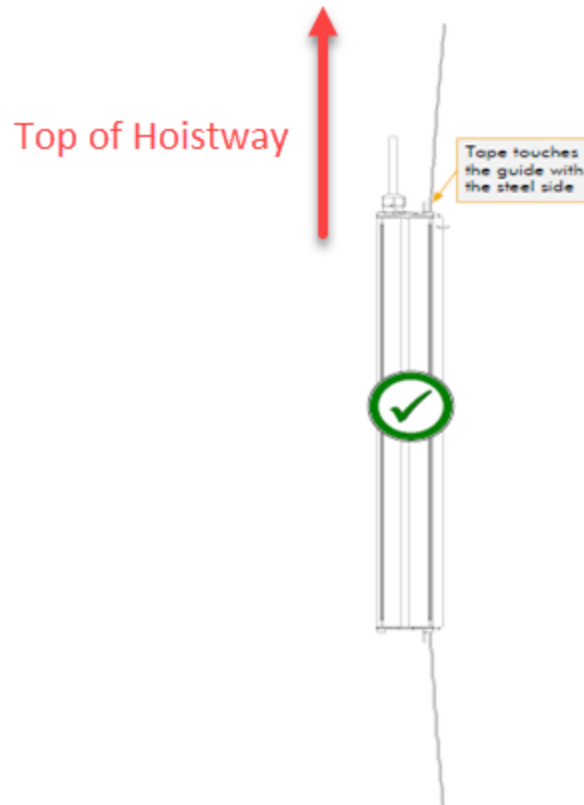

Figure 119: Magnetic Tape Installation¹

See the *ELGO Operating Manual* for proper tape installation.

¹ See ELGO Operating Manual LIMAX33 RED Safe Magnetic Absolute Shaft Information System

10.3 LEDs

There are three LEDs on the sensor (yellow, green, and red). Depending upon the input, each of the LEDs determine if the landing system is working properly or if an error has occurred. See the *ELGO Operating Manual* for the definition of each LED condition.

11 Learning the Hoistway

Prior to learning the hoistway, verify the number of floors and openings are correct (See Section 13.8 Floor Openings).

The following procedure describes how to learn the hoistway.

1. Bring the car to the top or bottom floor terminal.
2. Check if the DZ input to the CT board is high by:
 - Checking the top right corner of the Main screen.
 - Viewing status menus.
3. Verifying via Main screen:
 - i. If by verifying via Main screen, go to step 7.

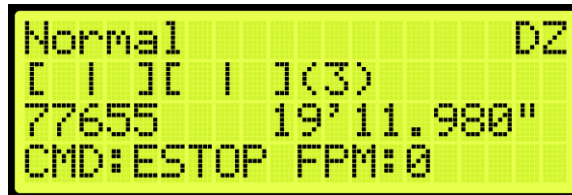

Figure 120: Check Status by Main Screen Method

- ii. If checking by Status screen, go to step 4.
4. Press the right button and navigate to MAIN MENU | STATUS | INPUTS (See Figure 45).
5. On the MR board, turn on DIP 5A.
6. The Main screen changes from Normal to Hold UP/DN To Start.

NOTE: verify the Fire Service signals are active, or the elevator will go into fire service after the Hoistway learn is complete.

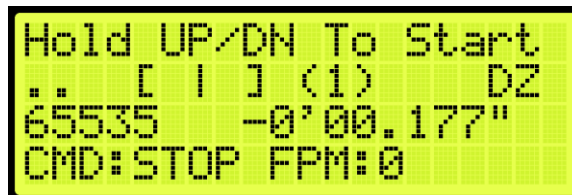

Figure 121: Normal to Hold UP/DN To Start

7. If the car at the top landing or bottom landing:
 - If the car is at the top landing, hold Enable and Down until the car starts moving.
 - If the car is at the bottom landing, hold Enable and Up until the car starts moving.
8. When the car stops, the screen shows Learn Complete.

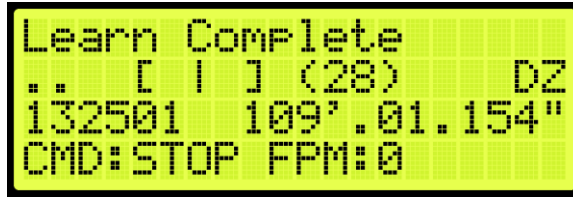

Figure 122: Learn Complete

9. On the MR board, turn off DIP 5A.

12 Speeds

Individual speed profiles can be set to operate the car.

12.1 Contract Speed

Contract speed should be set as the maximum speed the car is running at with an empty load. This helps to determine the factor which calculates the slowdown distance for different speed threshold.

The adjustment range is from 10 - 200 FPM.

- Default = Job Specific

Unit of Measure = FPM

The following procedure describes how to set the maximum speed.

1. Navigate to MAIN MENU | SETUP | SPEEDS (See Figure 57).
2. From the SPEEDS menu, scroll and select Contract Speed.



Figure 123: SPEEDS Menu – Contract Speed

3. From the CONTRACT SPEED menu, set the contract speed.

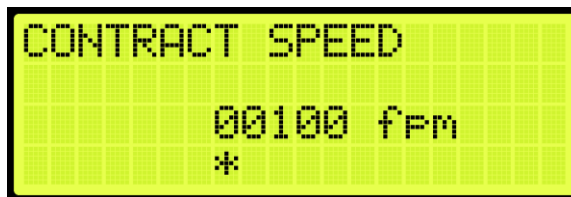

Figure 124: CONTRACT SPEED Menu

4. Scroll right and press Save.

12.2 Leveling Speed

Leveling speed is the steady state of the car when it moves at low speed with only the leveling valve active. The speed will be determined by how the leveling valves are adjusted. As the weights in the car increases, the leveling speed might decrease and the steady state of the car during leveling would be longer if the valves are unregulated.

The adjustment range is from 1-20 FPM.

- Default =5 FPM
- Unit of Measure = FPM

The following procedure describes how to set the leveling speed.

1. Navigate to MAIN MENU | SETUP | SPEEDS (See Figure 57).
2. From the SPEEDS menu, scroll and select Leveling Speed.

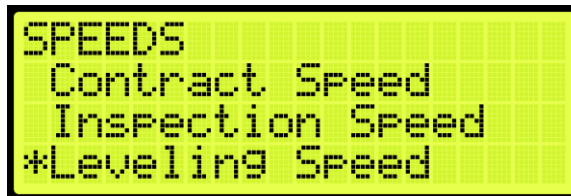

Figure 125: SPEEDS Menu – Leveling Speed

3. From the LEVELING SPEED menu, set the speed when leveling a car to a floor.



Figure 126: LEVELING SPEED Menu

4. Scroll right and press Save.

12.3 Test Buffer Speed

The test buffer speed is the speed set during buffer tests.

- If the speed is set equal to contract speed, the car will move at high speed.
- If the speed is anything else than contract speed, the car will move at the leveling speed.

NOTE: maximum speed is 200 fpm.

The following procedure describes how to set buffer speed for testing.

1. Navigate to MAIN MENU | SETUP | SPEEDS (See Figure 57).
2. From the SPEEDS menu, scroll and select Test Buffer Speed.

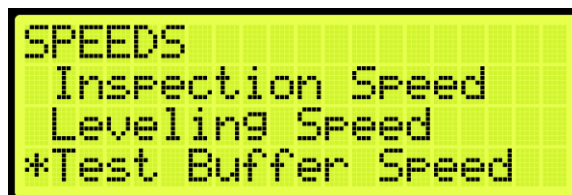

Figure 127: SPEEDS Menu – Test Buffer Speed

3. From the BUFFER SPEED menu, set the buffer speed.



Figure 128: BUFFER SPEED Menu

4. Scroll right and press Save.

13 Floors

For landing floors need to be set, the door that opens at each floor (if it opens), and other commands.

13.1 Number of Floors

Number of Floors allows the user to set the number of floors within the building.

The following procedure describes how to set the number of floors.

1. Navigate to MAIN MENU | SETUP | FLOORS (See Figure 57).
2. From the FLOORS menu, scroll and select Number of Floors.

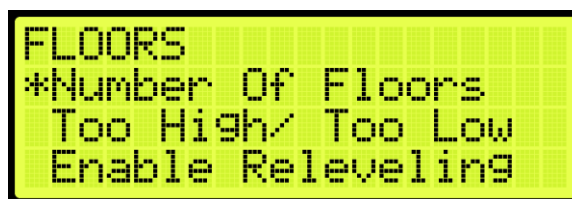

Figure 129: FLOORS Menu – Number Of Floors

3. From the NUMBER OF FLOORS MENU, scroll and set the number of floors.

NOTE: The number of floors should include any express zones that are serviced by other cars in the group. The opening map will reflect the floors the car serves.

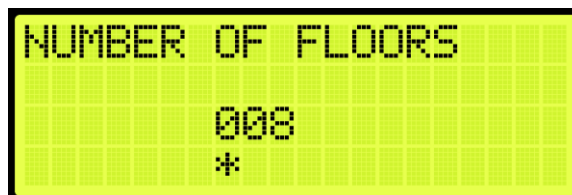

Figure 130: NUMBER Of FLOORS Menu

4. Scroll right and press Save.

13.2 Floor Adjustment

If the car does not stop at the exact floor level, tripping can occur. The floor adjustment allows for adjusting the stopping point of the elevator. The value will return to zero after the change has been saved.

13.2.1 Car is Too High/ Too Low

The car may stop either too low or too high from the floor level.

- If the car stops before floor level, increase the distance by the amount the car needs to move up.

- If the car stops above floor level, decrease the distance by the amount the car needs to move down.

The following procedure describes how to adjust the floor level.

1. Navigate to MAIN MENU | SETUP | FLOORS (See Figure 57).
2. From the FLOORS menu, scroll and select Too High/Too Low.



Figure 131: FLOORS Menu – Too High/Too Low

3. If the car is stopping too low or too high:
 - i. If the car stops too low, go to step 4.
 - ii. If the car stops too high, go to step 5.
4. From the ADJUST FLOORS menu, adjust the stopping point so the car stops at the exact floor level. For example, if the car stops 1.5”-2” below the floor level, add that distance to the learned position. Go to step 6.



Figure 132: ADJUST FLOORS Menu – Too Low

The ADJUST FLOORS menus display the following:

- Adjust Floors [1]: displays the floor the car is currently at.
 - [1] +001.791”: the distance the car needs to be adjusted to stop at floor level.
 - 01 = +00000091: the counts that determine the amount of distance needed for floor leveling.
5. From the ADJUST FLOORS menu, adjust the stopping point so the car stops at the exact floor level. For example, if the car stops 1.5”-2” above the floor level, remove that distance to the learned position.

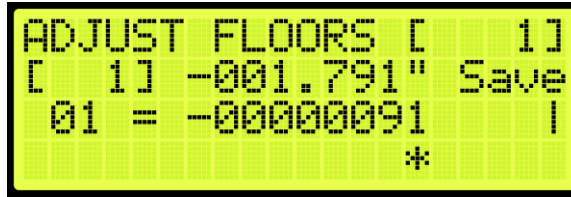

Figure 133: ADJUST FLOORS Menu – Too High

6. Scroll right and press Save.

13.3 Security Setting

Security must be set to ON per opening to lock out the floor. The front security marks the landings with front openings that are secured and are located under address 32-0008 - 32-0010. The rear opening mask marks the landings with rear openings that are secured and are located under addresses 32-0012 – 32-0014. For the list of parameters, see the *Hydro:Evolved Parameter List*.

NOTE: the security input must be assigned prior to setting up which floors require security access. See Section 21 Assigning Inputs and Outputs.

The following procedure describes how to setup security for front or rear car calls.

1. Navigate to MAIN MENU | SETUP | FLOORS (See Figure 57).
2. From the FLOORS menu, scroll and select Security (Front or Rear).

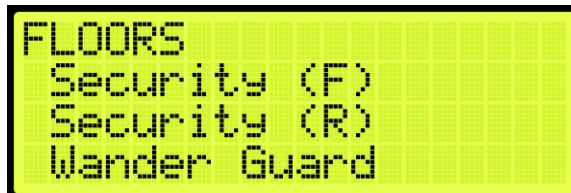

Figure 134: FLOORS Menu – Security (Front or Rear)

3. From the SECURITY FLOORS menu, scroll and select the floors the front or rear door will open at. Setting the floor to ON will enable security for the floor.

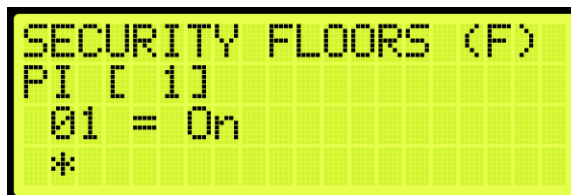

Figure 135: SECURITY FLOORS Menu

4. Scroll right and press Save.

13.4 Access Code

The access code is a feature that when a car call is initiated, its corresponding lamp flashes, and the user has a set amount of time to enter a 4-digit code (one digit at time). Access codes are available for a total combination of 16 landings the car serves (16 Front only, 16 Rear only, or 8 Front + 8 Rear only).

NOTE: consider a case where a job has more than 16 floors and the user wants to assign access codes to floors surpassing the 16th floor. The user will have to offset the access codes from the bottom floors to be able to assign access codes to the top floors required. For example, to assign access codes to floors 17-20, the user should offset access codes on floors 1-4. See Section 13.4.2 Offset Floors.

The system compares the user input sequence with the code stored in the parameter. If the Car Call Button (CCB) sequence is correct, the car call latches. If the code does not match or the time to enter the code has elapsed, the lamp stops flashing, and the user must start from the beginning by pressing the car call button and entering the correct code. Access code security is bypassed when the car is on Fire or EMS.

NOTE: debugging car calls bypasses all car call security options.

13.4.1 Front and Rear Access

The following is an example of how to set the front door access code.

1. Navigate to MAIN MENU | SETUP | ACCESS CODE (See Figure 63).
2. From the ACCESS CODE menu, scroll and select Access Codes (Front or Rear).

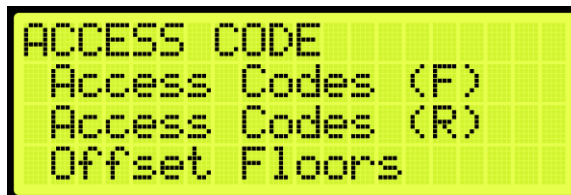

Figure 136: ACCESS CODE Menu – Access Codes (Front or Rear)

3. From the ACCESS CODES (Front or Rear) menu, scroll and select the car call floor that requires an access code.

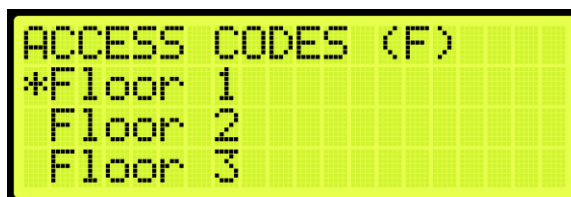

Figure 137: ACCESS CODES FRONT Menu – Floor Number

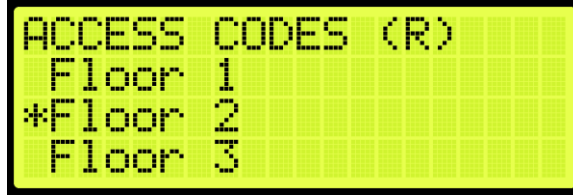

Figure 138: ACCESS CODES REAR Menu – Floor Number

- An access code may not have been previously set. If an access code has not been set, the display shows all dashes. Go to step 5.

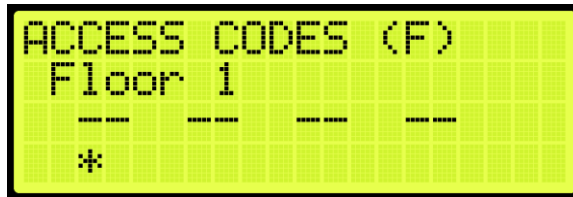

Figure 139: No Access Code

- From the FRONT or REAR ACCESS CODE menu, set the access code.

NOTE: when a front or rear floor has not been configured, the access code displays “n/a” for that floor.

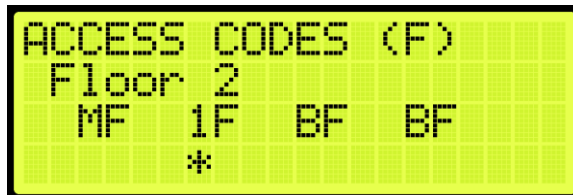

Figure 140: FRONT ACCESS CODE Menu

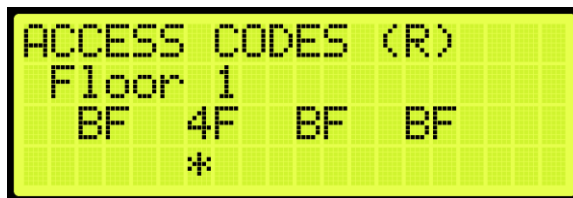

Figure 141: REAR ACCESS CODE Menu



Figure 142: Invalid Floor

6. Scroll right and press Save.
7. Additional floors to set up for special access:
 - i. If there are additional floors being set up for special access, scroll back to the ACCESS CODES (F or R) menu and go to step 5.
 - ii. If there are no more additional floors being set up for special access, the process is complete.

13.4.1.1 Additional Front/Rear Access

To set more 16 front door access codes, the user must first disable the access codes on the rear door, and vice versa.

The following is an example of how to disable access codes from front/rear doors.

1. Navigate to MAIN MENU | SETUP | ACCESS CODE (See Figure 63).
2. From the ACCESS CODE menu, scroll and select Enable Front (or Rear) Doors.

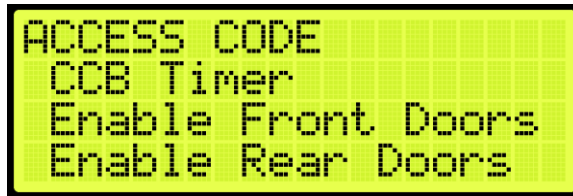

Figure 143: ACCESS CODE Menu – Enable Front (or Rear) Doors

3. From DISABLE FRONT DOORS (or DISABLE REAR DOORS) menu, select On.

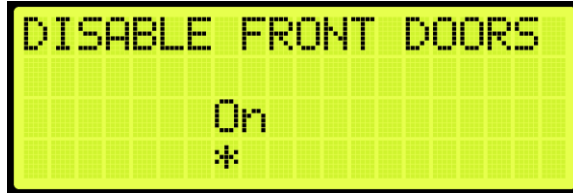

Figure 144: DISABLE FRONT DOORS Menu

4. Scroll right and press Save.

13.4.2 Offset Floors

The following is an example of how to offset floors that do not require access codes.

1. Navigate to MAIN MENU | SETUP | ACCESS CODE (See Figure 63).
2. From the ACCESS CODE menu, scroll and select Offset Floors.

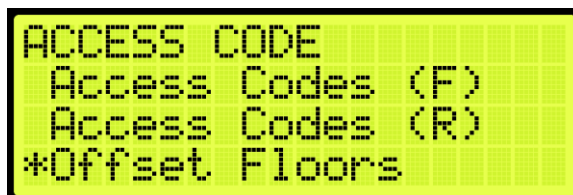

Figure 145: ACCESS CODE Menu – Offset Floors

3. From OFFSET FLOORS menu, set the number of floors to offset.

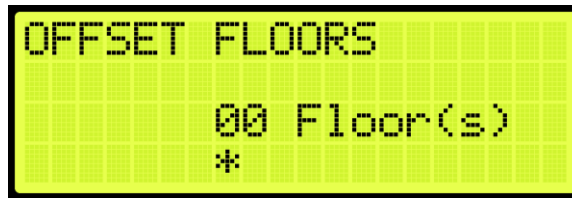

Figure 146: OFFSET FLOORS Menu

4. Scroll right and press Save.

13.4.3 Car Call Button Timer

The car call button timer is the set time in which the user must enter the access code one digit at a time. The user has an equivalent amount of time to enter each digit. If time has elapsed, the user must press the car call button and enter the code within the configured time frame.

NOTE: the default period is five seconds.

The following procedure describes how to set the time for a user to enter each digit of the access code.

1. Navigate to MAIN MENU | SETUP | ACCESS CODE (See Figure 63).
2. From the ACCESS CODE menu, scroll and select CCB Timer.

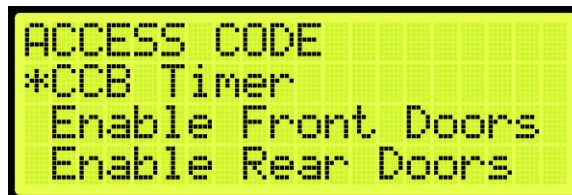

Figure 147: ACCESS CODE Menu – CCB Timer

3. From the CCB TIMER menu, set the time in which the user must enter each digit of the access code.

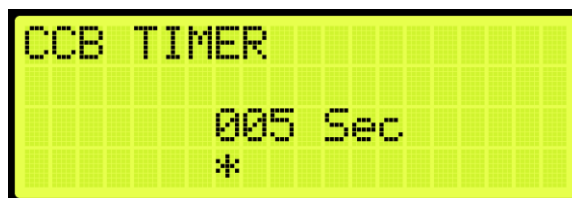

Figure 148: CCB TIMER Menu

4. Scroll right and press Save.

13.5 Enable Releveling

Load weight and velocity are calibrated when setting the landing point of a car. When the position indicator sends a signal that the position of the landing point of the car is not equal to the landing floor, the landing point must be recalibrated.

The following procedure describes how to enable releveling.

1. Navigate to MAIN MENU | SETUP | FLOORS (See Figure 57).
2. From the FLOORS menu, scroll and select Enable Releveling.



Figure 149: FLOORS Menu – Enable Releveling

3. From the ENABLE RELEVELING menu, select if releveling is enabled.



Figure 150: ENABLE RELEVELING Menu

4. Scroll right and press Save.

13.6 Relevel Zone Size

The dead zone is a software-defined area at a floor in which the car stops at floor level and does not trigger a relevel. A zone size too small will cause a yo-yoing effect, a zone too large would hinder the releveling operation and allow the car to remain off level.

The following procedure describes how to relevel zone size.

1. Navigate to MAIN MENU | SETUP | FLOORS (See Figure 57).
2. From the FLOORS menu, scroll and select Relevel Zone Size.

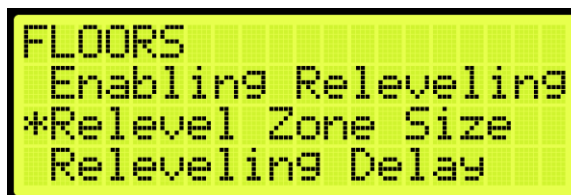

Figure 151: FLOORS Menu – Relevel Zone Size

3. From the RELEVEL ZONE SIZE menu, scroll and select the zone size.



Figure 152: RELEVEL ZONE SIZE Menu

4. Scroll right and press Save.

13.7 Releveling Delay

A delay time is set prior to the releveling process to allow the car to settle before triggering a releveling operation.

The following procedure describes how to set the relevel delay time.

1. Navigate to MAIN MENU | SETUP | FLOORS (See Figure 57).
2. From the FLOORS menu, scroll and select Releveling Delay.

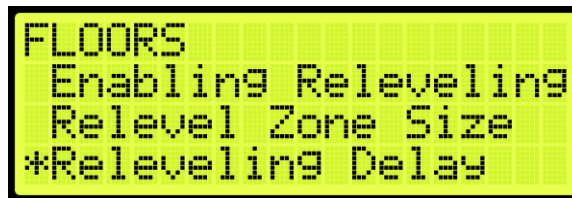

Figure 153: FLOORS Menu – Releveling Delay

3. From the RELEVELING DELAY menu, set the relevel delay time.



Figure 154: RELEVELING DELAY Menu

4. Scroll right and press Save.

13.8 Floor Openings

The front opening mask marks the landings that have front openings and are located under address 32-0000 – 32-0002. The rear opening mask marks the landings that have rear openings and are located under addresses 32-0004 – 32-0006. For the list of parameters, see the *Hydro:Evolved Parameter List*.

The following procedure describes how to set the floor the front door opens.

1. Navigate to MAIN MENU | SETUP | FLOORS (See Figure 57).
2. From the FLOOR menu, scroll and select Openings (Front or Rear).



Figure 155: FLOOR Menu – Openings

3. From the FLOOR OPENING (Front or Rear) menu, scroll and select the floors the front and/or rear door is going to open.

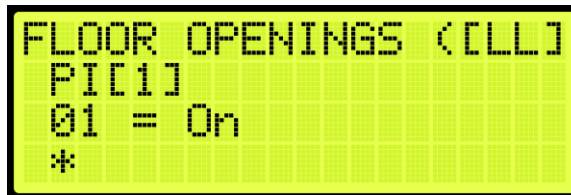

Figure 156: FLOOR OPENING Menu

4. Scroll right and press Save.

13.9 Wander Guard

Wander Guard is a security setting for preventing an unauthorized person from using the elevator. The car continues to run in normal operation but skips the floors set up for Wander Guard. In case the car does stop at that floor, the car stays at that floor and the doors remain open.

To set the controller to Wander Guard, see Section 21.1 Adding an Input or Output.

The following procedure describes how to set the floors for Wander Guard.

1. Navigate to MAIN MENU | SETUP | FLOORS (See Figure 57).
2. From the FLOORS menu, scroll and select Wander Guard.



Figure 157: FLOORS Menu – Wander Guard

- From the WANDER GUARD menu, scroll and set the desired floors for wander guard.



Figure 158: WANDER GUARD Menu

- Scroll right and press Save.

13.10 Store Floor Level

The store floor level stores the position of the floor level.

The following procedure describes how to store the car’s current position as the position of the selected floor.

- Navigate to MAIN MENU | SETUP | FLOORS (See Figure 57).
- From the FLOORS menu, scroll and select Store Floor Level.



Figure 159: FLOORS Menu – Store Floor Level

- From the STORE FLOORS menu, scroll and select which floors position that is being changed.

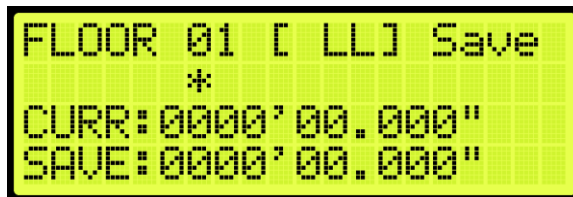

Figure 160: STORE FLOORS Menu

- Scroll right and press Save.

13.11 Short Floor Opening

A short floor is a floor that has an overlapping door zone with the previous floor. For example, if floor 5 and floor 6 have overlapping door zones, then floor 6 should be marked as a short floor.

The following procedure describes how to set overlapping door zones.

1. Navigate to MAIN MENU | SETUP | FLOORS (See Figure 57).
2. From the FLOORS menu, scroll and select Short Floor Opening.



Figure 161: FLOORS Menu – Short Floor Opening

3. From the SHORT FLOOR OPENING menu, scroll and select the short floor door zone.

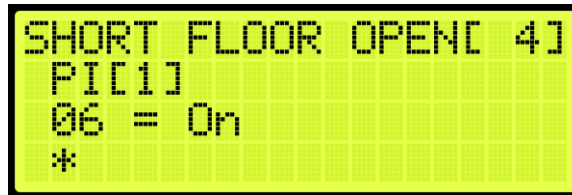

Figure 162: SHORT FLOOR OPENING Menu

4. Scroll right and press Save.

13.12 Timed Car Call Security

The timed car call security allows for a car call to be denied during specific times for any day of the week. When timed car call security is enabled, car calls that are time-secured will not latch. Access for the secured floors resume normal operation when the set period has passed, the timed car call security has been turned off, Car Call Enable Key is enabled, or Enable All Car Calls is activated.

If the access code is set, the access code overrides the timed car call security.

The following procedure describes how to set the front and rear time car call security.

1. Navigate to MAIN MENU | SETUP | FLOORS (See Figure 57).
2. From the FLOOR menu, scroll and select Timed Car Call Security.

```

FLOORS
  Store Floor Level
  Store Floor Opening
  *Timed CC Security
  
```

Figure 163: FLOOR Menu – Timed Car Call Security

3. From the TIMED CAR CALL SECURITY, scroll and select Enable Floor (Front or Rear).

```

TIMED CC SECURITY
  Enable Floor (F)
  Enable Floor (R)
  Start (M-F)
  
```

Figure 164: TIMED CC SECURITY Menu – Enable Floor (Front or Rear)

4. From the SECURITY FLOORS menu, select the front or rear secured floor (See Figure 135).
5. Scroll right and press Save.
6. To set the security floor for the weekday or weekend:
 - i. To set the security floor for the weekday, scroll back to Timed Car Call Security menu and go to step 7.
 - ii. To set the security floor for the weekend, scroll back to Timed Car Call Security menu and go to step 14.
7. From the TIMED CAR CALL SECURITY menu, scroll and select Start (M-F).

```

TIMED CC SECURITY
  Enable Floor (F)
  Enable Floor (R)
  *Start (M-F)
  
```

Figure 165: TIMED CAR CALL SECURITY Menu – Start (M-F)

8. From the WEEKDAY START TIME menu, set the start time of the car call security.

```

WEEKDAY START TIME

  01:00
  *
  
```

Figure 166: WEEKDAY START TIME Menu

9. Scroll right and press Save.
10. Press the left button until the TIMED CAR CALL SECURITY menu displays.
11. From the TIMED CAR CALL SECURITY menu, scroll and select Stop (M-F).



Figure 167: TIMED CAR CALL SECURITY Menu – Stop (M-F)

12. From the WEEKDAY STOP TIME menu, set the stop time of the car call security.



Figure 168: WEEKDAY STOP TIME Menu

13. Scroll right and press Save. The process is done.
14. From the TIMED CAR CALL SECURITY menu, scroll and select Start (S-S). Go to step 19.

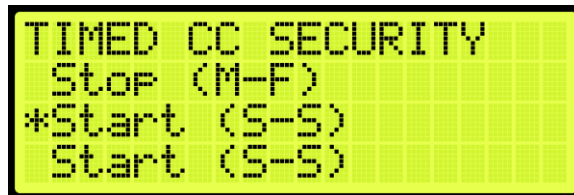

Figure 169: TIMED CAR CALL SECURITY Menu – Start (S-S)

15. From the WEEKEND START TIME menu, set the start time of the car call security.



Figure 170: WEEKEND START TIME Menu

16. Scroll right and press Save.
17. Press the left button until the TIMED CAR CALL SECURITY menu displays.
18. From the TIMED CAR CALL SECURITY menu, scroll and select Stop (S-S).



Figure 171: TIMED CAR CALL SECURITY Menu – Stop (S-S)

19. From the WEEKEND STOP TIME menu, set the stop time of the car call security.



Figure 172: WEEKEND STOP TIME Menu

20. Scroll right and press Save.

13.13 Timed Hall Call Security

The timed hall call security allows for a hall call to be denied access during certain times for any day of the week. When timed hall call security is enabled, hall calls that are time-secured will not latch. Hall calls resume normal operation when the set time period has past, the timed hall call security has been turned off, or Enable All Hall Calls is activated. All prior hall calls to non-secured floors are cancelled when hall call security has been enabled. However, all latched car calls will be completed.

The following procedure describes how to set the front and rear time hall call security.

1. Navigate to MAIN MENU | SETUP | FLOORS (See Figure 57).
2. From the FLOOR menu, scroll and select Timed Hall Call Security.

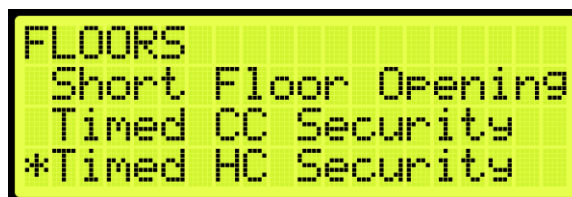

Figure 173: FLOOR Menu – Timed Hall Call Security

3. From the TIMED HALL CALL SECURITY, scroll and select Enable Floor (Front or Rear).

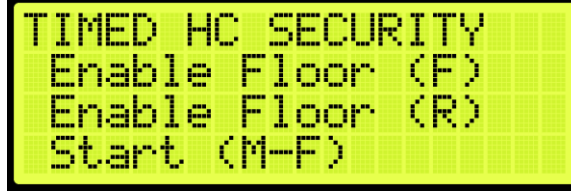

Figure 174: TIMED HALL CALL SECURITY Menu – Enable Floor (Front or Rear)

4. From the SECURITY FLOORS menu, select the front or rear secured floor (See Figure 135).
5. Scroll right and press Save.
6. To set the security floor for the weekday or weekend:
 - i. To set the security floor for the weekday, scroll back to TIMED HALL CALL SECURITY menu and go to step 7.
 - ii. To set the security floor for the weekend, scroll back to TIMED HALL CALL SECURITY menu and go to step 14.
7. From the TIMED HALL CALL SECURITY menu, scroll and select Start (M-F).

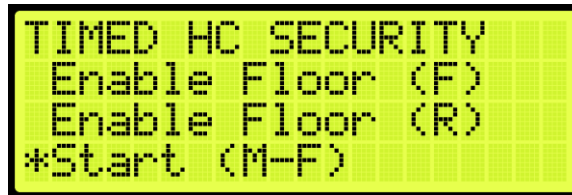

Figure 175: TIMED HALL CALL SECURITY Menu – Start (M-F)

8. From the WEEKDAY START TIME menu, set the start time of the hall call security (See Figure 166).
9. Scroll right and press Save.
10. Press the left button until the TIMED HALL CALL SECURITY menu displays.
11. From the TIMED HALL CALL SECURITY menu, scroll and select Stop (M-F).



Figure 176: TIMED HALL CALL SECURITY Menu – Stop (M-F)

12. From the WEEKDAY STOP TIME menu, set the stop time of the hall call security (See Figure 168).
13. Scroll right and press Save. The process is done.
14. From the TIMED HALL CALL SECURITY menu, scroll and select Start (S-S).



Figure 177: TIMED HALL CALL SECURITY Menu – Start (S-S)

15. From the WEEKEND START TIME menu, set the start time of the hall call security (See Figure 170).
16. Scroll right and press Save.
17. Press the left button until the TIMED HALL CALL SECURITY menu displays.
18. From the TIMED HALL CALL SECURITY menu, scroll and select Stop (S-S).



Figure 178: TIMED HALL CALL SECURITY Menu – Stop (S-S)

19. From the WEEKEND STOP TIME menu, set the stop time of the hall call security (See Figure 172).
20. Scroll right and press Save.

14 Sabbath Operation

There are two ways to initiate Sabbath operation:

- Turn on a key that is configured to an input.
- The clock on the controller reaches the Sabbath start time on Friday.

Once in Sabbath operation, the car goes to each door that has a valid Sabbath opening and skip those without a valid Sabbath opening. Sabbath operation has a separate door dwell timer. The door remains open based on the Sabbath timer and not the original door dwell timer. The car exits Sabbath operation if the Sabbath key is turned off or once the controller clock reaches the Sabbath end time on Saturday. For the list of parameters, see the *Hydro:Evolved Parameter List*.

The following procedure describes how to set the Sabbath operation.

1. Navigate to MAIN MENU | SETUP (See Figure 44).
2. To setup the Sabbath operation by Key Enable Only, Timer Enable Only, or Key or Timer Enable:
 - i. If the Sabbath operation is being set by Key Enable Only, go to step 3.
 - ii. If the Sabbath operation is being set by Timer Enable Only, go to step 35.
 - iii. If the Sabbath operation is being set by Key or Timer Enable, go to step 51.
3. Navigate to SETUP | SETUP I/O (See Figure 56).
4. From the SETUP I/O menu, scroll and select Setup Inputs.

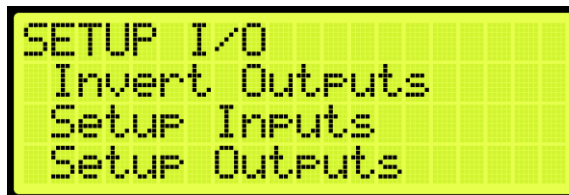

Figure 179: SETUP I/O Menu – Setup Inputs

5. From the SELECT BOARD menu, scroll and select the board the Sabbath key is wired to.

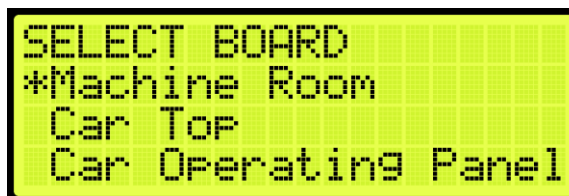

Figure 180: SELECT BOARD Menu – Machine Room

6. From the Input menu, scroll and select the configuration to be used as the Sabbath input.

NOTE: the X input is a representation of a number between 3-8.



Figure 181: Input Menu

7. Scroll right.
8. Scroll and select Auto Operation (See Figure 181).
9. Scroll right.
10. Scroll and select Sabbath (See Figure 181).
11. Scroll right and press Save.
12. Press the left button and navigate to SETUP | SABBATH (See Figure 62).
13. To setup the Sabbath operation with Key Enable Only or Key or Timer Enable Only:
 - i. If the Sabbath Operation is being setup for Key Enable Only, go to step 14.
 - ii. If the Sabbath Operation is being setup for Key or Timer Enable, go to step 18.
14. From the SABBATH menu, scroll and select Key Enable Only.

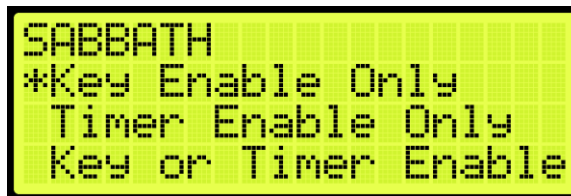

Figure 182: SABBATH Menu – Key Enable Only

15. From the KEY ENABLE ONLY menu, press the up button and select On.

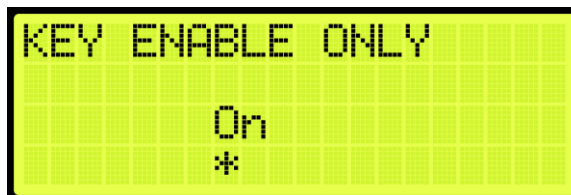

Figure 183: KEY ENABLE ONLY Menu

16. Scroll right and press Save.
17. Press the left button until the SABBATH menu is displayed.
18. From the SABBATH menu, scroll and select Floors Opening (F).



Figure 184: SABBATH Menu – Floors Opening (F)

19. From the FLOOR OPENING (Front) menu, scroll and select the front doors for each floor that opens during the Sabbath.

NOTE: the doors, that open, must be set to On.

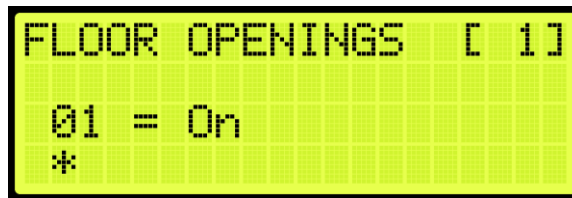

Figure 185: FLOOR OPENINGS (Front) Menu

20. Scroll right and press Save.

21. Press the left button until the SABBATH menu is displayed.

22. From the SABBATH menu, scroll and select Floors Opening (R).

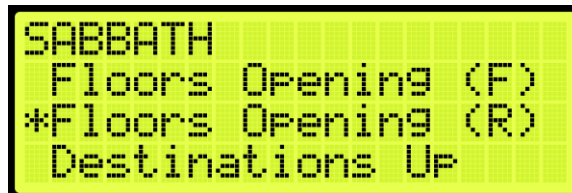

Figure 186: SABBATH Menu – Floors Opening (R)

23. From the FLOOR OPENING (Rear) menu, scroll and select the rear doors for each floor that opens during the Sabbath.



Figure 187: FLOORS OPENINGS (Rear) Menu

24. Scroll right and press Save.

25. Press the left button until the SABBATH menu is displayed.

26. From the SABBATH menu, scroll and select Destinations Up.



Figure 188: SABBATH Menu – Destinations Up

27. From the UP DESTINATIONS menu, scroll and select the up destination for the Sabbath.

- Ensure the highest down destination is below the highest up destination.
- Ensure the lowest down destination is above the lowest up destination.
- Up destinations should be different from down destinations.

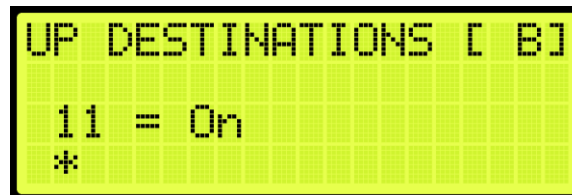

Figure 189: UP DESTINATIONS Menu

28. Scroll right and press Save.

29. Press the left button until the SABBATH menu is displayed.

30. From the SABBATH menu, scroll and select Destinations Down.

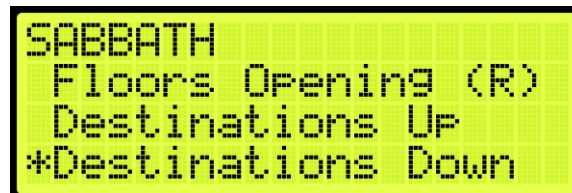

Figure 190: SABBATH Menu – Destinations Down

31. From the DOWN DESTINATIONS menu, scroll and select the down destination for the Sabbath.



Figure 191: DOWN DESTINATION Menu

32. To setup the Sabbath Operation for Key Enable Only, Timer Enable Only, or Key or Timer Enable:

- If the Sabbath Operation is being setup for Key Enable Only, go to step 34.

- ii. If the Sabbath Operation is being setup for Timer Enable Only, go to step 34.
 - iii. If the Sabbath Operation is being setup for Key or Timer Enable, go to step 33.
33. To setup the Sabbath Operation for Key or Timer Enable complete:
- i. If the setup for Sabbath for Key or Timer Enable is complete, go to step 34.
 - ii. If the setup for Sabbath for Key or Timer Enable is not complete go to step 38.
34. Scroll right and press Save. The process ends.
35. Navigate to SETUP | SABBATH (See Figure 62).
36. From the Sabbath menu, scroll and select Timer Enable Only.

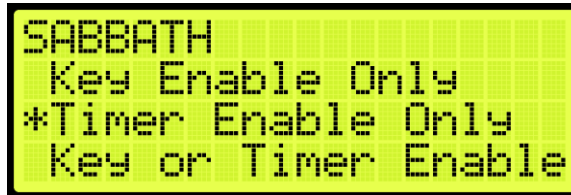

Figure 192: SABBATH Menu – Timer Enable Only

37. From the TIMER ENABLE ONLY menu, press the up button and select On.

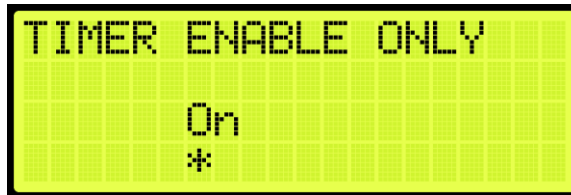

Figure 193: TIMER ENABLE ONLY Menu

38. Scroll right and press Save.
39. Press the left button until the SABBATH menu is displayed.
40. From the SABBATH menu, scroll and select Friday Start Time.

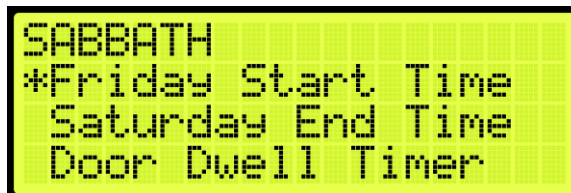

Figure 194: SABBATH Menu – Friday Start Time

41. Set the time the Sabbath starts.



Figure 195: FRIDAY START TIME Menu

42. Scroll right and press Save.
43. Press the left button until the SABBATH menu is displayed.
44. From the SABBATH menu, scroll and select Saturday End Time.

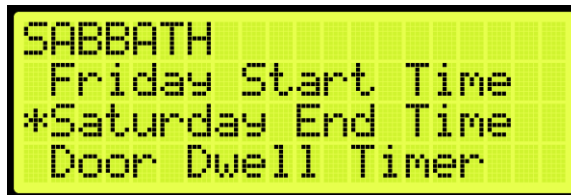

Figure 196: SABBATH Menu – SATURDAY END Time

45. Set the time the Sabbath ends.



Figure 197: SATURDAY END TIME Menu

46. Scroll right and press Save.
47. Press the left button until the SABBATH menu is displayed.
48. From the SABBATH menu, scroll and select Door Dwell Timer.

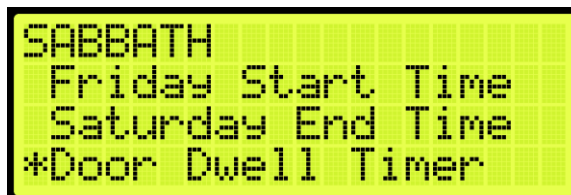

Figure 198: SABBATH Menu – Door Dwell Timer

49. From the DOOR DWELL TIMER menu, set the time the door stays open.



Figure 199: DOOR DWELL TIMER Menu

50. Scroll right and press Save. Go to step 17.
51. Navigate to SETUP | SABBATH (See Figure 62).
52. From the Sabbath menu, scroll and select Key or Timer Enable.

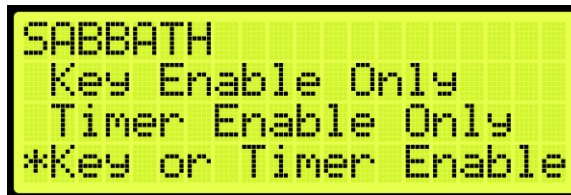

Figure 200: SABBATH Menu – Key or Timer Enable

53. From the KEY OR TIMER ENABLE menu, press the up button, and select On.

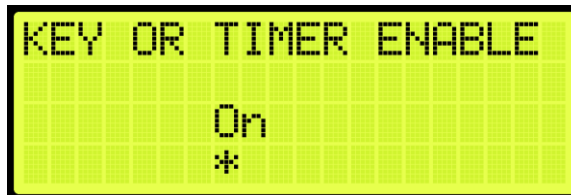

Figure 201: Key or Timer Enable Menu

54. Scroll right and press Save.
55. Press the left button until the SETUP menu is displayed and go to step 3.

15 Doors

The table below lists door symbols for each state.

Table 26: Door Symbols for Each State

State	Symbol
Unknown	"[?]"
Closed	"[]"
Closed With DC	
Opening	"[<]"
Opening With GSW	"[<]"
Opening With PHE	"[<*>]"
Open	"[]"
Open With DO	
Open With PHE	"[*]"
Open With PHE DO	
Partially Open	"[]"
Partially Open with PHE	"[*]"
Closing	"[>]"
Closing With GSW	"[>]"
Closing With PHE	"[>*>]"
Nudging	"[>!<]"

15.1 Control Doors

Doors can be manually controlled to open, close, or nudge.

The following procedure describes how to manually control the doors.

1. Navigate to MAIN MENU | SETUP | DOOR SETUP (See Figure 57).
2. From the DOORS menu, scroll and select Control Doors.

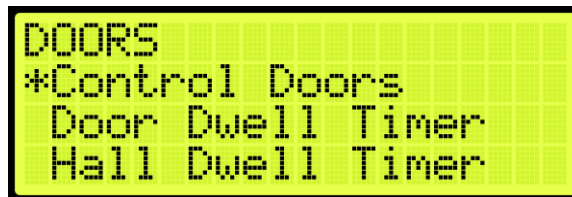

Figure 202: DOORS Menu – Control Doors

3. From the CONTROL DOORS menu, the user can:
 - Press and hold the middle button on the MR board to assert a Door Close command.
 - Under the Door Open option, the user can assert a Door Open Command to the Front or Rear doors.

- Under the Nudge option, the user can assert a Nudge command to the Front or Rear door.



Figure 203: CONTROL DOORS Menu

15.2 Door Dwell Timer

The door dwell timer is the time the car doors stay open when answering car calls.

The following procedure describes how to set the door dwell timer.

1. Navigate to MAIN MENU | SETUP | DOOR SETUP (See Figure 57).
2. From the DOORS menu, scroll and select Door Dwell Timer.

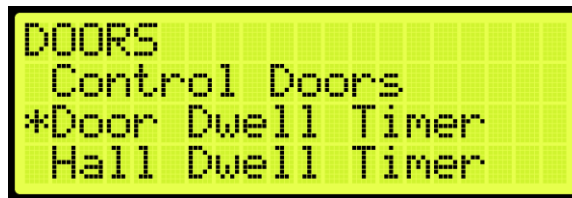

Figure 204: DOORS Menu –Door Dwell Timer

3. From the DOOR DWELL TIMER menu, set the time the doors stay open (See Figure 199).
4. Scroll right and press Save.

15.3 Hall Dwell Timer

The hall dwell timer is the time the doors stay open when responding to hall calls.

The following procedure describes how to set the hall dwell timer.

1. Navigate to MAIN MENU | SETUP | DOOR SETUP (See Figure 57).
2. From the DOORS menu, scroll and select Hall Dwell Timer.

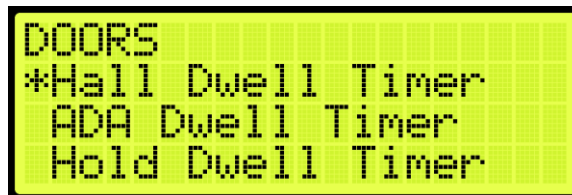

Figure 205: DOORS Menu – Hall Dwell Timer

3. From the HALL DWELL TIMER menu, set the time the doors stay open.



Figure 206: HALL DWELL TIMER Menu

4. Scroll right and press Save.

15.4 ADA Dwell Timer

The America's with Disabilities Act (ADA) timer is the time the doors stay open when answering calls from disabled passengers.

The following procedure describes how to set the ADA dwell timer.

1. Navigate to MAIN MENU | SETUP | DOOR SETUP (See Figure 57).
2. From the DOORS menu, scroll and select ADA Dwell Timer.

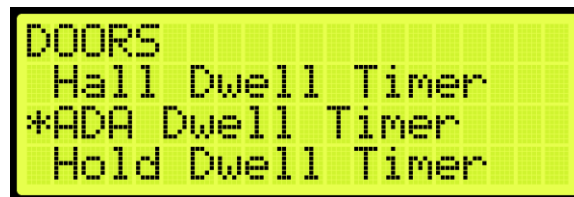

Figure 207: DOORS Menu – ADA Dwell Timer

3. From the ADA DWELL TIMER menu, set the time the doors stay open.



Figure 208: ADA DWELL TIMER Menu

4. Scroll right and press Save.

15.5 Hold Dwell Timer

The hold dwell timer is the time the doors stay open after a hold door button has been pressed.

The following procedures describe how to set the hold dwell timer.

1. Navigate to MAIN MENU | SETUP | DOOR SETUP (See Figure 57).

- From the DOORS menu, scroll and select Hold Dwell Timer.

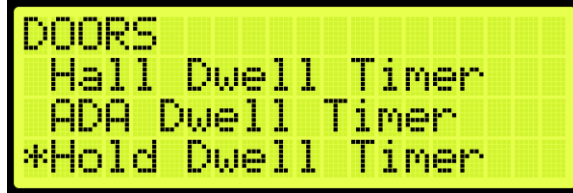

Figure 209: DOORS Menu – Hold Dwell Timer

- From the HOLD DWELL TIMER menu, set the time the doors stay open.

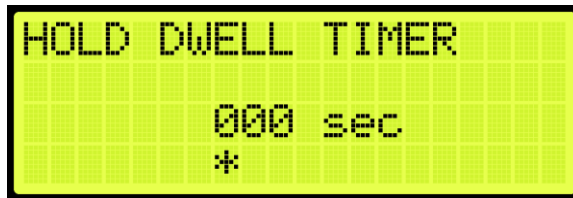

Figure 210: HOLD DWELL TIMER Menu

- Scroll right and press Save.

15.6 Lobby Dwell Timer

The lobby dwell timer is the time the doors stay open when the car answers calls at the lobby.

The following procedures describe how to set the lobby dwell timer.

- Navigate to MAIN MENU | SETUP | DOOR SETUP (See Figure 57).
- From the DOORS menu, scroll and select Lobby Dwell Timer.

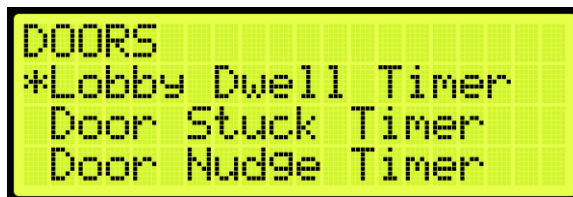

Figure 211: DOORS Menu – Lobby Dwell Timer

- From the LOBBY DWELL TIMER menu, set the time the doors stay open.



Figure 212: LOBBY DWELL TIMER Menu

4. Scroll right and press Save.

15.7 Door Stuck Timer

The door stuck timer is the time limit for the doors to completely open or close before a fault occurs.

The following procedures describe how to set the door stuck timer.

1. Navigate to MAIN MENU | SETUP | DOOR SETUP (See Figure 57).
2. From the DOORS menu, scroll and select Door Stuck Timer.

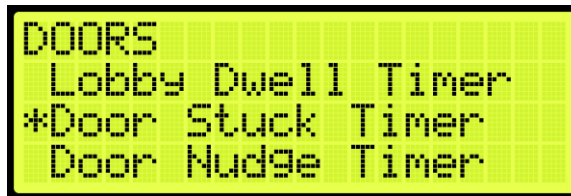

Figure 213: DOORS Menu – Door Stuck Timer

3. From the DOOR STUCK TIMER menu, set the time the doors completely open or close before faulting.

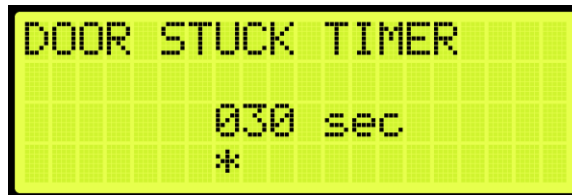

Figure 214: DOOR STUCK TIMER Menu

4. Scroll right and press Save.

15.8 Door Nudge Timer

The door nudge timer is the time the doors try to close after the door has been held open past a certain period. If set to zero, nudging is disabled.

The following procedures describe how to set the door nudge timer.

1. Navigate to MAIN MENU | SETUP | DOOR SETUP (See Figure 57).
2. From the DOORS menu, scroll and select Door Nudge Timer.

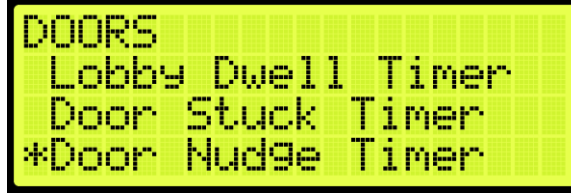

Figure 215: DOORS Menu – Door Nudge Timer

3. From the DOOR NUDGE TIMER menu, set the time the door tries to close after the period of time that the door has been opened elapsed.

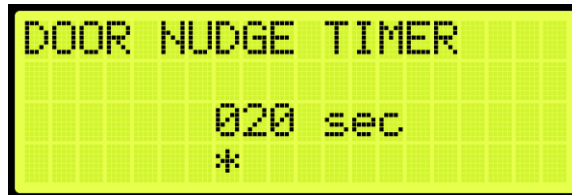

Figure 216: DOOR NUDGE TIMER Menu

4. Scroll right and press Save.

15.9 Rear Doors

The rear doors can be configured to be enabled or disabled. When enabled the rear door opens at designated landings.

The following procedure describes how to enable rear doors to open.

1. Navigate to MAIN MENU | SETUP | DOOR SETUP (See Figure 57).
2. From the DOORS menu, scroll and select Rear Doors.

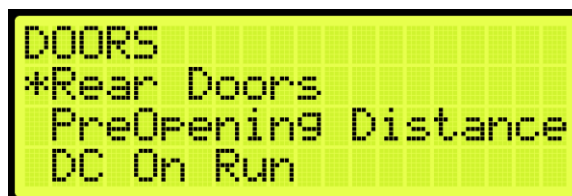

Figure 217: DOORS Menu – Rear Doors

3. From the REAR DOORS menu, scroll and select On for the rear doors to open.

NOTE: If rear doors are set to Off, the rear doors do not open.



Figure 218: REAR DOORS Menu

4. Scroll right and press Save.

15.10 PreOpening Distance

Preopening distance is the distance the doors start to open prior to the landing. The opening distance is limited by the door zone. Setting the distance outside of the door zone signal will cause the doors to begin opening as soon as DZ is active.

The following procedure describes how to set the preopening distance.

1. Navigate to MAIN MENU | SETUP | DOOR SETUP (See Figure 57).
2. From the DOORS menu, scroll and select PreOpening Distance.



Figure 219: DOORS Menu – PreOpening Distance

3. From the PREOPENING DISTANCE menu, set the distance from the landing the doors start to open.



Figure 220: PREOPENING DISTANCE Menu

4. Scroll right and press Save.

15.11 DC On Run

The DC On Run activates a door close output when the car is in motion. This can be useful if doors require constant pressure to prevent relaxing.

The following procedure describes how to set the DC on Run.

1. Navigate to MAIN MENU | SETUP | DOOR SETUP (See Figure 57).
2. From the DOORS menu, scroll and select DC On Run.

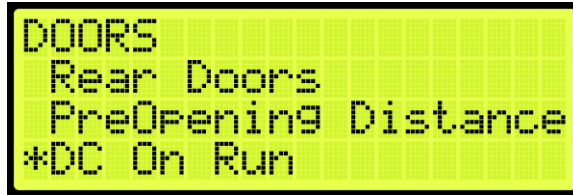

Figure 221: DOORS Menu – DC On Run

3. From the DC ON RUN menu, scroll and select On to enable the doors to close when the car is in motion.



Figure 222: DC ON RUN Menu

4. Scroll right and press Save.

15.12 DC On Close

The DC On Close activates a door close output while the doors are in a closed state. This can be useful if doors require constant pressure to prevent relaxing.

The following procedure describes how to set the DC on Close.

1. Navigate to MAIN MENU | SETUP | DOOR SETUP (See Figure 57).
2. From the DOORS menu, scroll and select DC On Close.

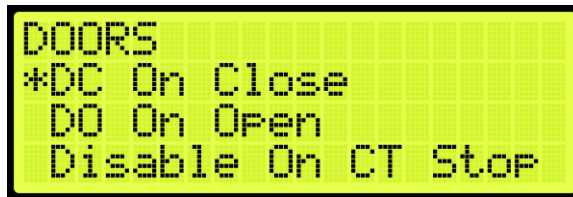

Figure 223: DOORS Menu – DC On Close

3. From the DC ON DOOR CLOSE menu, scroll and select On to enable the doors to close.



Figure 224: DC ON DOOR CLOSE Menu

4. Scroll right and press Save.

15.13 DO On Open

The DO On Open activates a door open output while the doors are in an open state. This can be useful if doors require constant pressure to prevent relaxing.

The following procedure describes how to set the DO on Open.

1. Navigate to MAIN MENU | SETUP | DOOR SETUP (See Figure 57).
2. From the DOORS menu, scroll and select DO On Open.



Figure 225: DOORS Menu – DO On Open

3. From the DO ON DOOR OPEN menu, scroll and select On to enable the doors to open.



Figure 226: DO ON DOOR OPEN Menu

4. Scroll right and press Save.

15.14 Disable on CT Stop

Door outputs are disabled when the top CT Stop switch is enabled.

The following procedure describes how to disable all door outputs.

1. Navigate to MAIN MENU | SETUP | DOOR SETUP (See Figure 57).
2. From the DOORS menu, scroll and select Disable On CT Stop.



Figure 227: DOORS Menu – Disable On CT Stop

- From the DISABLE ON CT STOP menu, scroll and select On to disable all door outputs.



Figure 228: DISABLE ON CT STOP Menu

- Scroll right and press Save.

15.15 Disable on HA

Door outputs are disabled when the Hoistway Access (HA) is active.

The following procedure describes how to disable all door outputs.

- Navigate to MAIN MENU | SETUP | DOOR SETUP (See Figure 57).
- From the DOORS menu, scroll and select Disable On HA.



Figure 229: DOORS Menu – Disable On HA

- From the DISABLE ON HA menu, scroll and select On to disable all door outputs.



Figure 230: DISABLE ON HA Menu

- Scroll right and press Save.

15.16 AT400 Doors

If the job is configured with an AT400 door operator, this option needs to be enabled.

The following procedure describes how to enable AT400 interface.

1. Navigate to MAIN MENU | SETUP | DOOR SETUP (See Figure 57).
2. From the DOORS menu, scroll and select AT400 Doors.



Figure 231: DOORS Menu – AT400 Doors

3. From the ENABLE AT400 DOOR menu, scroll and select On.

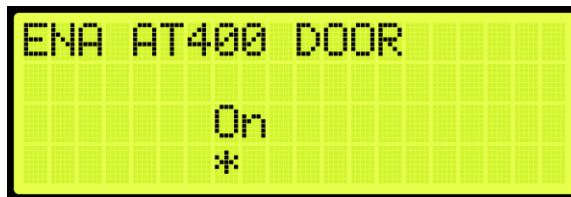

Figure 232: ENABLE AT400 DOOR Menu

4. Scroll right and press Save.

15.17 No Demand Doors Open

The No Demand Doors Open option allows the car doors to stay open while the car is idle.

The following procedure describes how to set the doors to remain open when the car is idle.

1. Navigate to MAIN MENU | SETUP | DOOR SETUP (See Figure 57).
2. From the DOORS menu, scroll and select No Demand Doors Open.



Figure 233: DOORS Menu – No Demand Doors Open

3. From the NO DEMAND DOORS OPEN menu, scroll and select On to keep the doors open while the car is idle.



Figure 234: NO DEMAND DOORS OPEN Menu

4. Scroll right and press Save.

15.18 Jumper Timer

The jumper timer detects if the GSW or door locks are still jumped. When jumpers are detected after a configured amount of time, a fault occurs. This time is added to a fixed 1.6 second timeout.

The following description describes how to set the time for verifying jumpers prior to a fault.

1. Navigate to MAIN MENU | SETUP | DOOR SETUP (See Figure 57).
2. From the DOORS menu, scroll and select Jumper Timer.

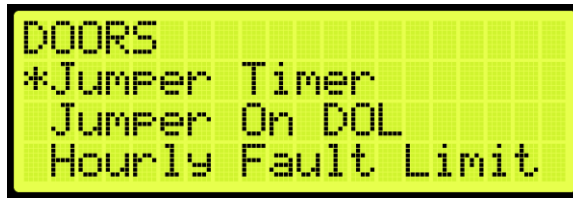

Figure 235: DOORS Menu – Jumper Timer

3. From the JUMPER TIMEOUT menu, set the time to verify there are no jumpers attached to the GSW or door locks.

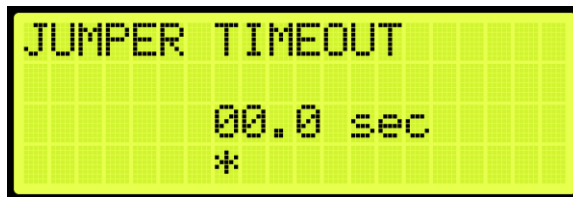

Figure 236: JUMPER TIMEOUT Menu

4. Scroll right and press Save.

15.19 Jumper on DOL

The door open limit (DOL) and GSW send signals to determine whether the door is open or closed. When the Jumper on DOL is enabled, the controller detects a jumper on an open DOL instead of the GSW.

The following procedure describes how to verify if there are jumpers on an open DOL.

1. Navigate to MAIN MENU | SETUP | DOOR SETUP (See Figure 57).
2. From the DOORS menu, scroll and select Jumper On DOL.

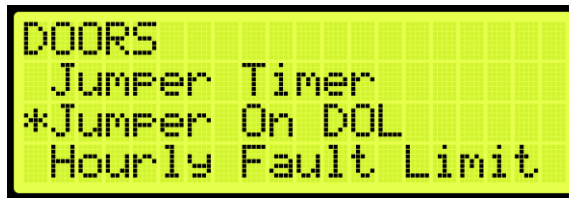

Figure 237: DOORS Menu – Jumper On DOL

3. From the LOCK JUMPED ON DOL menu, scroll and select On to verify jumpers are detected on the DOL.

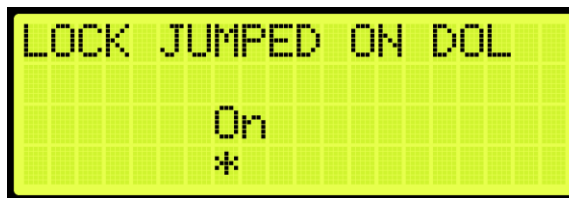

Figure 238: LOCKS JUMPED ON DOL Menu

4. Scroll right and press Save.

15.20 Hourly Fault Limit

The hourly fault is the number of door faults allowed per hour prior to the car going out of service. The car remains out of service until the hour window elapses.

The following procedure describes how to set the hourly fault limit.

1. Navigate to MAIN MENU | SETUP | DOOR SETUP (See Figure 57).
2. From the DOORS menu, scroll and select Hourly Fault Limit.

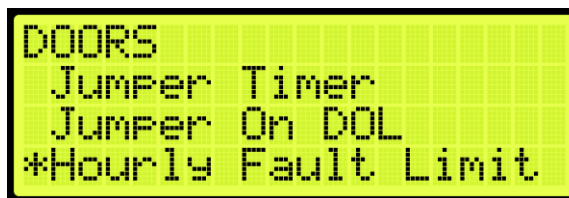

Figure 239: DOORS Menu – Hourly Fault Limit

3. From the DOOR HOURLY FAULT LIMIT menu, set the number of logged faults allowed per hour before the car goes out of service.



Figure 240: DOOR HOURLY FAULT LIMIT Menu

4. Scroll right and press Save.

15.21 Nudge – Buzzer Only

When enabled during nudging, the Nudge (NDG) output is disabled and only the buzzer sounds.

The following procedure describes how to only enable the buzzer during nudging.

1. Navigate to MAIN MENU | SETUP | DOOR SETUP (See Figure 57).
2. From the DOORS menu, scroll and select Nudge – Buzzer Only.

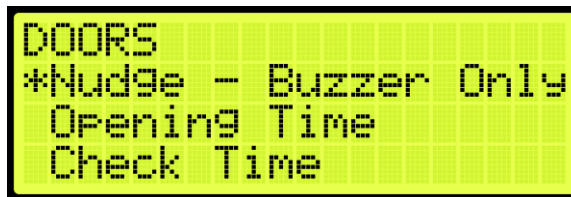

Figure 241: DOORS Menu – Nudge – Buzzer Only

3. From the NUDGE – BUZZER ONLY menu, scroll and select On if the buzzer sounds when nudging.

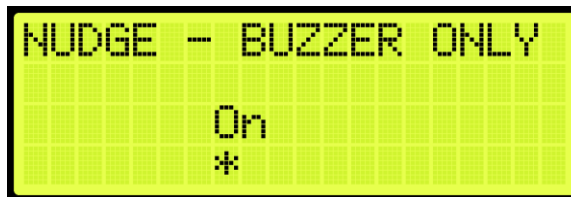

Figure 242: NUDGE – BUZZER ONLY Menu

4. Scroll right and press Save.

15.22 Opening Time

The opening time is the time for a door to go from fully closed to fully open. This allows the controller to estimate door opening time for use during preflight operation.

The following procedure describes how to set the time to fully open the doors.

1. Navigate to MAIN MENU | SETUP | DOOR SETUP (See Figure 57).

- From the DOORS menu, scroll and select Opening Time.



Figure 243: DOORS Menu – Opening Time

- From the OPENING TIME menu, set the time for the doors to fully open.

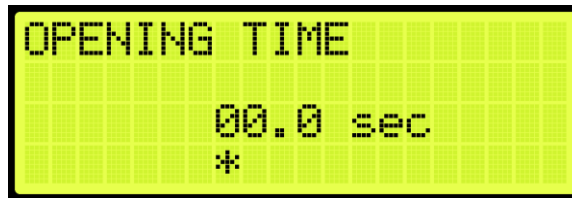

Figure 244: OPENING TIME Menu

- Scroll right and press Save.

15.23 Check Time

The check time is the configured amount of time that the doors need to be considered safe before the car is allowed to run on automatic operation.

The following procedure describes how to set the check time.

- Navigate to MAIN MENU | SETUP | DOOR SETUP (See Figure 57).
- From the DOORS menu, scroll and select Check Time.

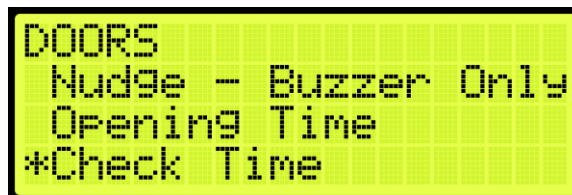

Figure 245: DOORS Menu – Check Time

- From the CHECK TIME menu, set the time to check if the doors are considered safe.

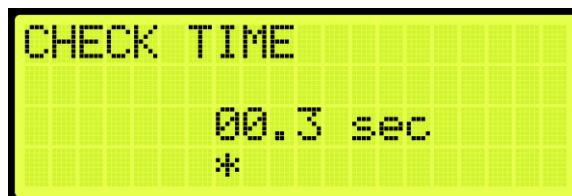

Figure 246: CHECK TIME Menu

4. Scroll right and press Save.

15.24 Door Type

The door type is the type of door used on the front or rear landing. The user can set the controller for a different type of door used on all front landings and all rear landings. The type of doors are as follows:

- Automatic
- Freight
- Manual
- Swing

The following procedure describe how to select the front or rear door type.

1. Navigate to MAIN MENU | SETUP | DOOR SETUP (See Figure 57).
2. From the DOORS menu, scroll and select Door Type (Front or Rear).

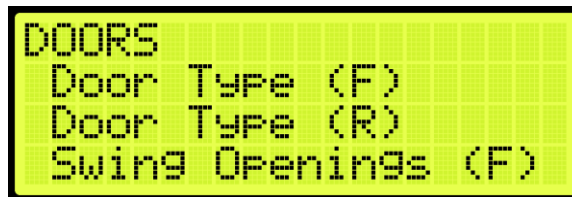

Figure 247: DOORS Menu – Door Type (Front or Rear)

3. From the DOOR TYPE menu, select the type of door used on the front and the type of door used on the rear landing as applicable.

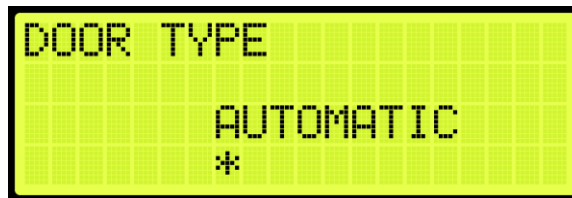

Figure 248: DOOR TYPE Menu

4. Scroll right and press Save.

15.25 Lock and CAM Timeout

Sets the timeout which accounts for the delay between CAM activation and locks being made for manual doors. The units are in 100 ms counts. If set to zero, value defaults to 4 seconds.

The following procedure describes how to set the lockout time for lock and cam.

1. Navigate to MAIN MENU | SETUP | DOOR SETUP (See Figure 57).

- From the DOORS menu, scroll and select Lock and CAM Timeout.



Figure 249: DOORS Menu – Lock and CAM Timeout

- From the TIMEOUT LOCK AND CAM menu, set the amount of time for the timeout.

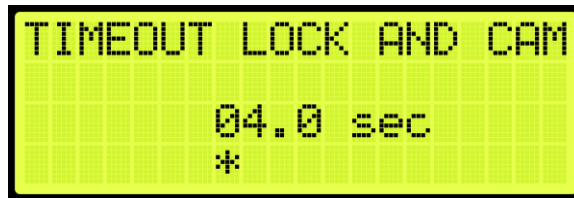

Figure 250: TIMEOUT LOCK AND CAM Menu

- Scroll right and press Save.

15.26 Retiring CAM

When set to ON, the CAM output controls hall interlocks. When set to OFF, interlocks are controlled by the door operator.

The following procedure describes how to set the retiring CAM on.

- Navigate to MAIN MENU | SETUP | DOOR SETUP (See Figure 57).
- From the DOORS menu, scroll and select Retiring CAM.



Figure 251: DOORS Menu – Retiring CAM

- From the RETIRING CAM menu, scroll and select On.



Figure 252: RETIRING CAM Menu

4. Scroll right and press Save.

15.27 Fixed CAM

When set to ON, the door has a fixed hall CAM. The car is allowed to start a run without hall locks (hall closed contacts still required). The car is allowed to move for the duration set in 08-137 (TimeoutLockAndCAM_100ms), defaulting to 4 seconds if set to zero, before faulting.

The following procedure describes how to set the fixed CAM on.

1. Navigate to MAIN MENU | SETUP | DOOR SETUP (See Figure 57).
2. From the DOORS menu, scroll and select Fixed CAM.



Figure 253: DOORS Menu – Fixed CAM

3. From the FIXED CAM menu, scroll and select On.



Figure 254: FIXED CAM Menu

4. Scroll right and press Save.

15.28 Swing Lock GSW Timeout

Sets the timeout between GSW and locks. If the value is zero, the timeout is set to 500 ms.

The following procedure describes how to set the timeout for the Swing Lock Gate switch.

1. Navigate to MAIN MENU | SETUP | DOOR SETUP (See Figure 57).
2. From the DOORS menu, scroll and select SWING LOCK GSW TIMEOUT.



Figure 255: DOORS Menu – Swing Lock GSW Timeout

- From the SWING LOCK GSW TIMEOUT menu, set the amount of time for the Swing Lock Gate switch will timeout.



Figure 256: SWING LOCK GSW TIMEOUT Menu

- Scroll right and press Save.

15.29 Swing Contacts Timeout

Sets the timeout between CAM being energized and closed contacts being made. If value is zero, timeout is set to 500 ms.

The following procedure describes how to set the timeout for swing contacts.

- Navigate to MAIN MENU | SETUP | DOOR SETUP (See Figure 57).
- From the DOORS menu, scroll and select Swing Contacts Timeout.



Figure 257: DOORS Menu – Swing Contacts Timeout

- From the SWING CONTACTS TIMEOUT menu, set the amount of time for the swing contacts to timeout.



Figure 258: SWING CONTACTS TIMEOUT Menu

- Scroll right and press Save.

15.30 Disable DOB Rear

When set to ON, the rear DOB will be disabled.

The following procedure describes how to disable the rear DOB.

1. Navigate to MAIN MENU | SETUP | DOOR SETUP (See Figure 57).
2. From the DOORS menu, scroll and select Disable DOB Rear.



Figure 259: DOORS Menu – Disable DOB Rear

3. From the DISABLE REAR DOB menu, scroll and select ON to disable rear door.



Figure 260: DISABLE REAR DOB Menu

4. Scroll right and press Save.

15.31 Front Door State

The front door state displays the current state of the car with front door opening.

The following procedure describes how to view the state of the front door.

1. Navigate to MAIN MENU | DEBUG | VIEW DEBUG DATA (Figure 66).
2. From the VIEW DEBUG DATA menu, press the right button.
3. Scroll up and right until code 043 is displayed.



Figure 261: VIEW DEBUG DATA Menu – Front Door

4. View the state of the front door.

The Door State menus display the following:

- Front or Rear Door State: the symbol for the state of the door (See Table 26).
- Current Door Command: the current door command being issued to the door module (See Table 27).
- Last Door Command: the last door command issued to the door module (See Table 27).
- Current Door Timer: the counter tracking when the door state should change. Each count is 200 ms.
- Door Timer Limit: the limit the Current Door Timer needs to reach before proceeding to the next door state. Each count is 200 ms.

The table below lists the door command issued to the Door Module.

Table 27: Door Command Issued to the Door Module

Command Index	Door Command
0	None
1	OPEN UI REQUEST
2	OPEN IN CAR REQUEST
3	OPEN ADA MODE
4	OPEN SABBATH MODE
5	OPEN HALL REQUEST
6	OPEN HOLD REQUEST
7	OPEN CONSTANT PRESSURE
8	CLOSE
9	CLOSE CONSTANT PRESSURE
10	NUDGE
11	NUDGE CONSTANT PRESSURE
12	FAULT
13	OPEN HOLD DWELL REQUEST
14	OPEN LOBBY REQUEST
15	OPEN RECALL DWELL REQUEST

15.32 Rear Door State

The rear door state displays the current state of the car with rear door opening.

The following procedure describes how to view the state of the rear door.

1. Navigate to MAIN MENU | DEBUG | VIEW DEBUG DATA (Figure 66).
2. From the View Debug Data menu, press the right button.
3. Scroll up and right until code 044 is displayed.

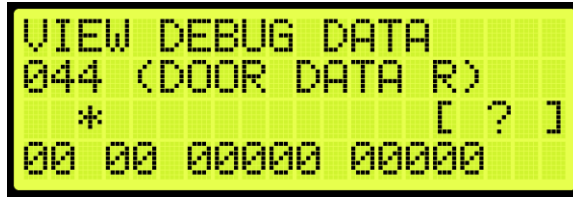

Figure 262: VIEW DEBUG DATA Menu – Rear Door

4. View the state of the rear door.

See Section 15.31 Front Door State for the door state, commands, and command descriptions.

16 Car Data

The Car Data can be used to view important dispatching and car status information passed between grouped cars. It can be used to debug dispatching issues.

16.1 Car Data Overview

The following procedure describes how to view the car status overview.

1. Navigate to MAIN MENU | DEBUG | CAR DATA (See Figure 67)
2. View the Car Data Overview Status.

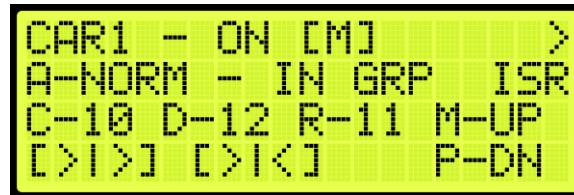

Figure 263: Car Data Overview Status

The Car Data Overview shows:

- **Car ID:** displays the selected cars ID number. Valid from 1 to 8.
- **Online Status:** displays ON if the car is online and broadcasting on the group network, otherwise it reads OFF.
- **Master Status:** displays [M] if the car is acting as the master dispatcher for the group.
- **Class and Mode of Operation:** displays the cars class of operation as a single letter abbreviation, followed by the mode of operation.
- **In Group Status:** displays IN GRP if the car is in group and currently accepting hall calls.
- **ISR Flags:** a flag is displayed depending on the status of the car.
 - If the car is idle and able to perform a direction change, the “I” displays instead of “.”.
 - If the car is stopped or decelerating, the “S” displays instead of “.”.
 - If the car door reopening is blocked in preparation for a run, the “R” displays instead of “.”.
- **Current Landing:** displays the car’s current landing number, preceded by C-.
- **Destination Landing:** displays the car’s destination landing number, preceded by D-.
- **Reachable Landing:** displays the car’s estimated closest reachable landing number, preceded by R-. This landing is calculated based on the cars ability to slow down with current Digital S-curve Technology™ (U.S. Patent Pending) values.
- **Motion Status:** displays the car’s motion status. If the car is not moving up (M-UP) or moving down (M-DN), then the car motion displays M-ST.

- **Direction Priority:** displays the car’s direction priority. If the car is serving up calls it appears as P-UP, otherwise it will appear P-DN.

The table below lists the Car Status codes.

Table 28: Car Status Codes

Code	Description
Unknown	
U-UNK	Unknown
Manual	
M-UNK	Unknown
M-INV	Invalid
M-NON	None
M-CT	Car Top Inspection
M-IC	In-Car Inspection
M-HA	Hoistway Access
M-MR	Machine Room Inspection
M-PIT	Pit Inspection
M-LND	Landing Inspection
M-CON	Construction
M-HAT	Hoistway Access (Top)
M-HAB	Hoistway Access (Bottom)
Learn	
L-UNK	Unknown
L-INV	Invalid
L-NON	None
L-G ₂ T	Go to A Terminal
L-RB ₁	L-SSD (code)
L-RB ₂	L-LSD (code)
L-BHA	Bypass Term Limits
L-RHA	Hold UP/DN To Start
L-LB ₁	L-SSU (code)
L-LB ₂	L-LSU (code)
L-LHU	Learning BTM To TOP
L-LHD	Learning TOP To BTM
L-EBP	L-LHU (code)
L-INV	L-LHD (code)
L-CMP	Learn Complete
Automatic	
A-UNK	Unknown
A-NON	None
A-NORM	Normal
A-FIR ₁	Fire Phase 1

Code	Description
A-FIR ₂	Fire Phase 2
A-EMS ₁	EMS Phase 1
A-EMS ₂	EMS Phase 2
A-ATTD	Attendant
A-INDP	Independent Service
A-SEIS	Seismic
A-CWDR	Counterweight Derail
A-SABB	Sabbath
A-EPWR	Emergency Power
A-EVAC	Invalid
A-OOS	Out of Service
A-C2L	Car To Lobby
A-BATR	Battery Rescue
A-PRS1	Prison Transport 1
A-PRS2	Prison Transport 2
A-R2F	Recall To Floor
A-WG	Wander Guard
A-HUGS	HUGS
A-ER2F	Emergency Recall
A-TEST	Test Mode
A-WIND	Wind Operation
A-FLD	Flood Operation
A-SWING	Swing Operation
A-CUST	Custom Operation
A-ACTS	Code: A-SHOO
A-MARS	Marshal Mode
A-VIP	VIP Mode
A-T2T	Normal Terminal To Terminal
A-F2F	Normal Floor To Floor
A-RAND	Normal Random
A-STI	Shunt Trip Mode

16.2 Hall Call Mask Status

Hall call mask status displays the status of front, rear, and latchable hall calls.

The following procedure describes how to view the hall call mask status.

1. Navigate to MAIN MENU | DEBUG | CAR DATA (See Figure 67).
2. From the Car Data Overview Status (See Figure 263), press the right button.
3. View the Hall Mask Status.



Figure 264: Hall Mask Status

The table below lists the Hall Mask Status definitions.

Table 29: Hall Mask Status Definitions

Hall Mask Code	Definition	Description
HMF	Front hall mask	Marks which front hall calls can be taken
HMR	Rear hall mask	Marks which rear hall calls can be taken
HML	Latchable hall mask	Marks which hall calls can be latched

To view hall mask errors, see Section 17.12 Split Group Masks

When a different Hall Mask and EMS Mask is required, the “Override Group Hall Mask” input should be activated. This will cause the cars within the group to split, allowing a different EMS mask and a different Hall Mask to be applied. The Override Group Hall Mask (08-0146) and the Override Group Medical Mask (08-0273) will replace the previously used Hall Call Mask (08-0209) and Hall Medical Mask (08-0210), respectively.

Errors.

16.3 Opening Map Status

The opening map status displays which landings have front or rear openings enabled.

16.3.1 Front Opening Map Status

The following procedure describes how to view the front opening map status.

1. Navigate to MAIN MENU | DEBUG | CAR DATA (See Figure 67).
2. From the Car Data Overview Status (See Figure 263), press the right button.
3. From the Hall Mask Status (See Figure 264), press the right button.
4. View the Front Opening Map Status. Opening Map Front 1 (OMF1) represents the hex value for the first 32 landings that have front openings. OMF2 represents landings 33-64 and OMF3 represents landings 65-96.



Figure 265: Front Opening Map Status

16.3.2 Rear Opening Map Status

The following procedure describes how to view the rear opening map status.

1. Navigate to MAIN MENU | DEBUG | CAR DATA (See Figure 67).
2. From the Car Data Overview Status (See Figure 263), press the right button.
3. From the Hall Mask Status (See Figure 264), press the right button.
4. From the Front Opening Map Status (See Figure 265), press the right button.
5. View the Rear Opening Map Status. Opening Map Rear 1 (OMR1) represents the hex value for the first 32 landings that have rear openings. OMR2 represents landings 33-64 and OMR3 represents landings 65-96.



Figure 266: Rear Opening Map Status

16.4 Security Map Status

The security map status displays the status of secure landings.

16.4.1 Front Security Map Status

The following procedure describes how to view the front security map status.

1. Navigate to MAIN MENU | DEBUG | CAR DATA (See Figure 67).
2. From the Car Data Overview Status (See Figure 263), press the right button.
3. From the Hall Mask Status (See Figure 264), press the right button.
4. From the Front Opening Map Status (See Figure 265), press the right button.
5. From the Rear Opening Map Status (See Figure 266), press the right button.
6. View the Front Security Map Status. Security Mask Front 1 (SMF1) represents hex value for first 32 front openings that have security enabled. SMF2 represents the next 32 front openings.



Figure 267: Front Security Map Status

16.4.2 Rear Security Map Status

The following procedure describes how to view the rear security map status.

1. Navigate to MAIN MENU | DEBUG | CAR DATA (See Figure 67).
2. From the Car Data Overview Status (See Figure 263), press the right button.
3. From the Hall Mask Status (See Figure 264), press the right button.
4. From the Front Opening Map Status (See Figure 265), press the right button.
5. From the Rear Opening Map Status (See Figure 266), press the right button.
6. From the Front Security Map Status (See Figure 267), press the right button.
7. View the Rear Security Map Status. Security Mask Rear 1 (SMR1) represents hex value for first 32 rear openings that have security enabled. SMR2 represents the next 32 rear openings.



Figure 268: Rear Security Map Status

16.5 Linked Hall Mask Status

The linked hall call masks are used to tie together the lamps of separate hall buttons. Each paired mask must be set to the sum of the hall call masks for each of the paired boards. The paired hall call parameters addresses are located at 08-0178 – 08-0181. For the list of parameters, see the *Hydro:Evolved Parameter List*.

The linked hall mask status displays which Hall board outputs are tied together.

The following procedure describes how to view the linked hall mask status.

1. Navigate to MAIN MENU | DEBUG | CAR DATA (See Figure 67).
2. From the Car Data Overview Status (See Figure 263), press the right button.
3. From the Hall Mask Status (See Figure 264), press the right button.
4. From the Front Opening Map Status (See Figure 265), press the right button.

5. From the Rear Opening Map Status (See Figure 266), press the right button.
6. From the Front Security Map Status (See Figure 267), press the right button.
7. From the Rear Security Map Status (See Figure 268), press the right button.
8. View the Linked Hall Mask status.

NOTE: the following example shows:

- First mask (LM1) pairs the front Hall Call boards.
- Second mask (LM2) pairs the rear Hall Call boards.

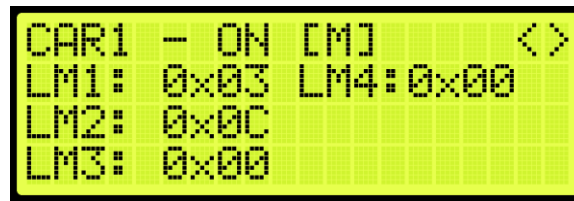

Figure 269: Linked Hall Mask Status

16.6 Hall Security Map Status

The hall security map marks the landings that require hall security contacts. The front hall security map parameters are 16-0940 – 16-0945 and the rear hall security map parameters are located under address 16-1035 – 16-1040. For the list of parameters, see the *Hydro:Evolved Parameter List*.

16.6.1 Front Hall Security Map Status

The following procedure describes how to view the front hall security map status.

1. Navigate to MAIN MENU | DEBUG | CAR DATA (See Figure 67).
2. From the Car Data Overview Status (See Figure 263), press the right button.
3. From the Hall Mask Status (See Figure 264), press the right button.
4. From the Front Opening Map Status (See Figure 265), press the right button.
5. From the Rear Opening Map Status (See Figure 266), press the right button.
6. From the Front Security Map Status (See Figure 267), press the right button.
7. From the Rear Security Map Status (See Figure 268), press the right button.
8. From the Linked Hall Mask Status (See Figure 269), press the right button.
9. View the Front Hall Security Map Status.



Figure 270: Front Hall Security Map Status

16.6.2 Rear Hall Security Map Status

The following procedure describes how to view the rear hall security map status.

1. Navigate to MAIN MENU | DEBUG | CAR DATA (See Figure 67).
2. From the Car Data Overview Status (See Figure 263), press the right button.
3. From the Hall Mask Status (See Figure 264), press the right button.
4. From the Front Opening Map Status (See Figure 265), press the right button.
5. From the Rear Opening Map Status (See Figure 266), press the right button.
6. From the Front Security Map Status (See Figure 267), press the right button.
7. From the Rear Security Map Status (See Figure 268), press the right button.
8. From the Linked Hall Mask Status (See Figure 269), press the right button.
9. From the Front Hall Security Map Status (See Figure 270), press the right button.
10. View the Rear Hall Security Map Status.

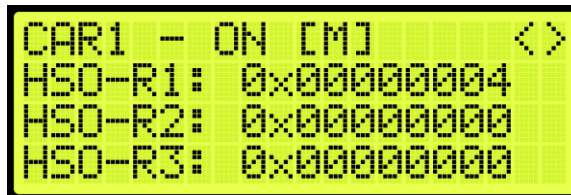

Figure 271: Rear Hall Security Map Status

16.7 Hall Security Mask Status

The hall security mask displays the status of all enabled secured hall calls.

The hall security bypass status (BYP) is ON if the hall security is disabled. This occurs if the Enable Hall Security option is OFF (parameter 01-0138) or the Enable All HC input is programmed and active. For the list of parameters, see the *Hydro:Evolved Parameter List*.

The following procedure describes how to view the hall security mask status.

1. Navigate to MAIN MENU | DEBUG | CAR DATA (See Figure 67).
2. From the Car Data Overview Status (See Figure 263), press the right button.

3. From the Hall Mask Status (See Figure 264), press the right button.
4. From the Front Opening Map Status (See Figure 265), press the right button.
5. From the Rear Opening Map Status (See Figure 266), press the right button.
6. From the Front Security Map Status (See Figure 267), press the right button.
7. From the Rear Security Map Status (See Figure 268), press the right button.
8. From the Linked Hall Mask Status (See Figure 269), press the right button.
9. From the Front Hall Security Map Status (See Figure 270), press the right button.
10. From the Rear Hall Security Map Status (See Figure 271), press the right button.
11. View the Front and Rear Hall Security Mask Status.

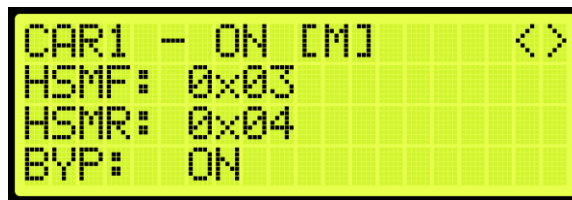

Figure 272: Front and Rear Hall Security Mask Status

16.8 Dispatching Timer Status

The dispatching timer status displays the configured amount of time the car has to respond to hall calls before being taken out of the group.

The following procedure describes how to view the dispatching timer status.

1. Navigate to MAIN MENU | DEBUG | CAR DATA (See Figure 67).
2. From the Car Data Overview Status (See Figure 263), press the right button.
3. From the Hall Mask Status (See Figure 264), press the right button.
4. From the Front Opening Map Status (See Figure 265), press the right button.
5. From the Rear Opening Map Status (See Figure 266), press the right button.
6. From the Front Security Map Status (See Figure 267), press the right button.
7. From the Rear Security Map Status (See Figure 268), press the right button.
8. From the Linked Hall Mask Status (See Figure 269), press the right button.
9. From the Front Hall Security Map Status (See Figure 270), press the right button.
10. From the Rear Hall Security Map Status (See Figure 271), press the right button.
11. From the Front and Rear Hall Security Mask Status (See Figure 272), press the right button.
12. View the Dispatching Timers Status.

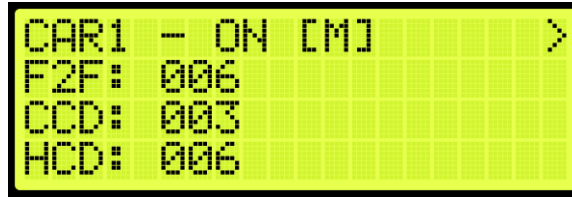

Figure 273: Dispatching Timers Status

The Dispatching Timers Status menu displays the following:

- **F2F:** the car's estimated floor to floor (worst-case) time.
- **CCD:** the period the doors remain open when responding to car calls (See Section 15.2 Door Dwell Timer).
- **HCD:** the period the doors remain open when responding to hall calls (See Section 15.3 Hall Dwell Timer).

16.9 VIP Flags

The VIP flags define the status of the VIP Mode of the car within the group.

The following procedure describes how to view the status of VIP.

1. Navigate to MAIN MENU | DEBUG | CAR DATA (See Figure 67).
2. From the Car Data Overview Status (See Figure 263), press the right button.
3. From the Hall Mask Status (See Figure 264), press the right button.
4. From the Front Opening Map Status (See Figure 265), press the right button.
5. From the Rear Opening Map Status (See Figure 266), press the right button.
6. From the Front Security Map Status (See Figure 267), press the right button.
7. From the Rear Security Map Status (See Figure 268), press the right button.
8. From the Linked Hall Mask Status (See Figure 269), press the right button.
9. From the Front Hall Security Map Status (See Figure 270), press the right button.
10. From the Rear Hall Security Map Status (See Figure 271), press the right button.
11. From the Front and Rear Hall Security Mask Status (See Figure 272), press the right button.
12. From the Dispatching Timers Status (See Figure 273), press the right button.
13. View the VIP Flags Status.



Figure 274: VIP Flags Status

The VIP Flags menu displays the following:

- **bVIP:** when the setting is 1, the VIP Mode has been enabled.
- **bCarCapture:** when the setting is 1, the car is being captured prior to a VIP call assignment.
- **bCarReady:** when the setting is 1, the car is captured and ready to take a VIP call assignment.

16.10 VIP Masks

The VIP masks mark which hall riser functions the car can serve in VIP Mode.

The following procedure describes how to view the VIP masks.

1. Navigate to MAIN MENU | DEBUG | CAR DATA (See Figure 67).
2. From the Car Data Overview Status (See Figure 263), press the right button.
3. From the Hall Mask Status (See Figure 264), press the right button.
4. From the Front Opening Map Status (See Figure 265), press the right button.
5. From the Rear Opening Map Status (See Figure 266), press the right button.
6. From the Front Security Map Status (See Figure 267), press the right button.
7. From the Rear Security Map Status (See Figure 268), press the right button.
8. From the Linked Hall Mask Status (See Figure 269), press the right button.
9. From the Front Hall Security Map Status (See Figure 270), press the right button.
10. From the Rear Hall Security Map Status (See Figure 271), press the right button.
11. From the Front and Rear Hall Security Mask Status (See Figure 272), press the right button.
12. From the Dispatching Timers Status (See Figure 273), press the right button.
13. From the VIP Flag Status (See Figure 274), press the right button.
14. View the VIP (Front and Rear) Mask Status.

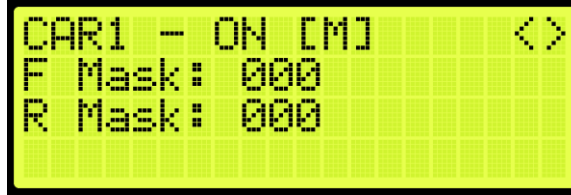

Figure 275: VIP Mask Status

16.11 Car Call Enable Bitmap Status

The car call enable signals (signals that bypass car call security) active on the car in bitmap form. Each bit in the map represents a front or rear opening for a different group landing.

16.11.1 Front Car Call Enable Bitmap Status

The following procedure describes how to view the Front Car Call Enable Bitmap Status.

1. Navigate to MAIN MENU | DEBUG | CAR DATA (See Figure 67).
2. From the Car Data Overview Status (See Figure 263), press the right button.
3. From the Hall Mask Status (See Figure 264), press the right button.
4. From the Front Opening Map Status (See Figure 265), press the right button.
5. From the Rear Opening Map Status (See Figure 266), press the right button.
6. From the Front Security Map Status (See Figure 267), press the right button.
7. From the Rear Security Map Status (See Figure 268), press the right button.
8. From the Linked Hall Mask Status (See Figure 269), press the right button.
9. From the Hall Security Map Status (See Figure 270), press the right button.
10. From the Front Hall Security Map Status (See Figure 270), press the right button.
11. From the Rear Hall Security Map Status (See Figure 271), press the right button.
12. From the Dispatching Timers Status (See Figure 273), press the right button..
13. From the VIP Flags Status (See Figure 363), press the right button.
14. View the VIP (Front and Rear) Mask Status (See Figure 275), press the right button.
15. View the Front Car Call Enable Bitmap Status.

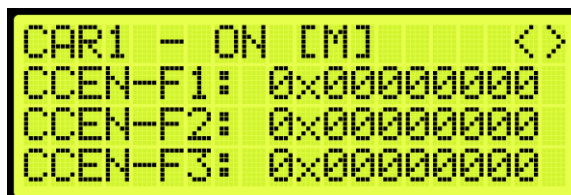

Figure 276: Front Car Call Enable Bitmap Status

16.11.2 Rear Car Call Enable Bitmap Status

The following procedure describes how to view the Rear Car Call Enable Bitmap Status.

1. Navigate to MAIN MENU | DEBUG | CAR DATA (See Figure 67).
2. From the Car Data Overview Status (See Figure 263), press the right button.
3. From the Hall Mask Status (See Figure 264), press the right button.
4. From the Front Opening Map Status (See Figure 265), press the right button.
5. From the Rear Opening Map Status (See Figure 266), press the right button.
6. From the Front Security Map Status (See Figure 267), press the right button.
7. From the Rear Security Map Status (See Figure 268), press the right button.
8. From the Linked Hall Mask Status (See Figure 269), press the right button.
9. From the Hall Security Map Status (See Figure 270), press the right button.
10. From the Front Hall Security Map Status (See Figure 270), press the right button.
11. From the Rear Hall Security Map Status (See Figure 271), press the right button.
12. From the Dispatching Timers Status (See Figure 273), press the right button.
13. From the VIP Flags Status (See Figure 363), press the right button.
14. View the VIP (Front and Rear) Mask Status (See Figure 275), press the right button.
15. From the Front Car Call Enable Bitmap Status (See Figure 276), press the right button.
16. View the Rear Car Call Enable Bitmap Status.

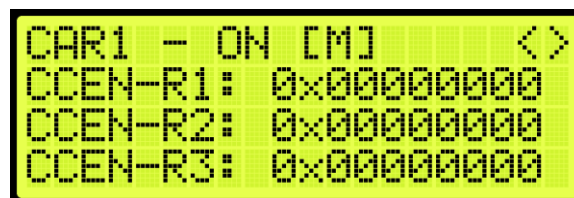

Figure 277: Rear Car Call Enable Bitmap Status Menu

16.12 Emergency Medical Call Mask and Landing

The Emergency Medical Call Mask and Landing is the status of a car in the group that is designated for emergencies.

The following procedure describes how to view the Emergency Medical Call Mask and Landing.

1. Navigate to MAIN MENU | DEBUG | CAR DATA (See Figure 67).
2. From the Car Data Overview Status (See Figure 263), press the right button.
3. From the Hall Mask Status (See Figure 264), press the right button.

4. From the Front Opening Map Status (See Figure 265), press the right button.
5. From the Rear Opening Map Status (See Figure 266), press the right button.
6. From the Front Security Map Status (See Figure 267), press the right button.
7. From the Rear Security Map Status (See Figure 268), press the right button.
8. From the Linked Hall Mask Status (See Figure 269), press the right button.
9. From the Hall Security Map Status (See Figure 270), press the right button.
10. From the Front Hall Security Map Status (See Figure 270) press the right button.
11. From the Rear Hall Security Map Status (See Figure 271), press the right button.
12. From the Dispatching Timers Status (See Figure 273), press the right button.
13. From the VIP Flags Status (See Figure 363), press the right button.
14. View the VIP (Front and Rear) Mask Status (See Figure 275), press the right button.
15. From the Front Car Call Enable Bitmap Status (See Figure 276), press the right button.
16. From the Rear Car Call Enable Bitmap Status (See Figure 277), press the right button.
17. View the Emergency Medical Call Mask and Landing Status.

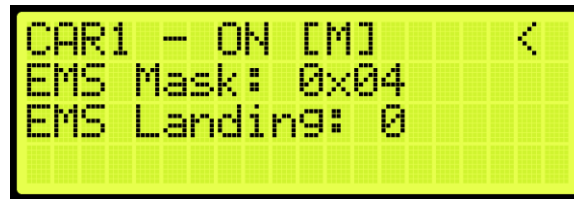

Figure 278: Emergency Medical Call Mask and Landing

View the Emergency Medical Call Mask and Landing StatusThe Emergency Medical Call Mask and Landing menu displays the following:

- **EMS Mask:** the hall mask for the hall risers that are interpreted as hall medical calls by this car.
- **EMS Landing:** if an emergency medical call has been assigned to the car, this field reflect the landing of the call, where “1” is the lowest landing served by the group and “0” is no assignment.

17 Hall Network

The hall network is a group of Hall boards connected by a CAN bus.

17.1 CAN Bus

Each Hall board communicates over a CAN bus to a Riser board located in the machine room.

The figure below shows a standard CAN network. For optimal performance, the cable stub lengths should be kept short and only node 1 and node 4 on the CAN bus line should be terminated.

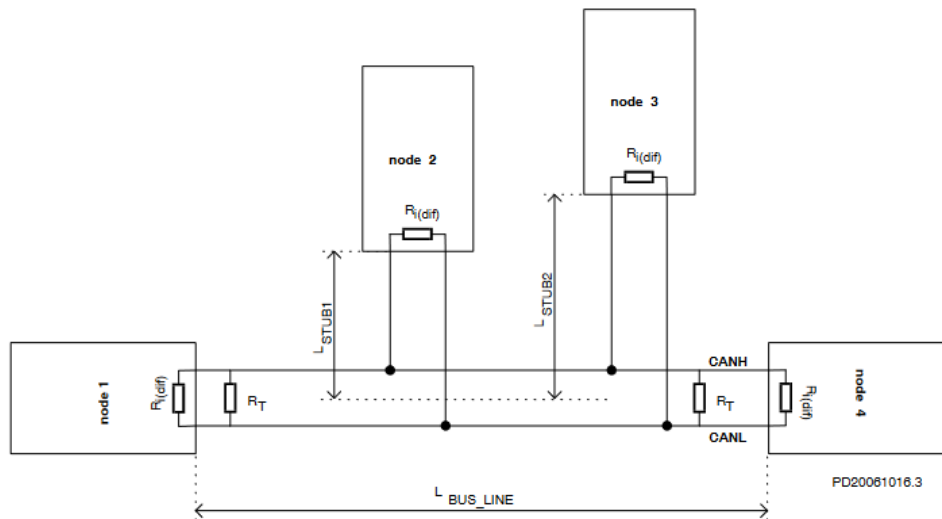

Figure 279: Standard CAN Bus²

Termination: the first and last boards within each CAN network are terminated. See Section 2.3 I/O Board/Riser Board SR3031 for more information.

- **Example 1:** a single set of hall buttons are wired to Riser board 1.
 - The Riser board's CAN2 termination and the bottom landing Hall board's termination is set.
- **Example 2:** two sets of Hall buttons are both wired to Riser board 1.
 - The bottom landing Hall board for each Hall board set is terminated. The Riser board's CAN2 is NOT terminated. For tall buildings, the second set of Hall boards may need to be split off and connected to a second Riser board. Both networks are terminated as described in example 1.

² See <https://www.onsemi.com/pub/Collateral/AND8376-D.PDF> for CAN Bus with Unterminated Stubs

NOTE: for most Hydro:Evolved PCB boards, a jumper is used to terminate the CAN bus. For Hall boards, the termination is set by switching DIP 10 or DIP 12 to ON depending on the type of Hall board. See Table 10 and Table 11 for switch settings.

Stub Length: a CAN bus resembles a long branch with only short ‘stubs’ coming out of it. These stubs are kept shorter than 1 ft in length. See Figure 279.

Connections: a twisted pair is used over CAT5 splitters whenever possible. For networks with over 20 Hall boards, additional power and REF connections will be needed to mitigate voltage drops.

17.2 Hall Board Status

If problems occur due to hall calls, start by checking the Hall board Status UI menu.

The Hall board status display gives information on each board’s communication status, error state, connected Riser board, I/O and DIP addressing.

The following procedure describes how to verify Hall board status.

1. Navigate to MAIN MENU | STATUS | HALL BOARD STATUS (See Figure 48).
2. The example below shows the Status of the Hall board.

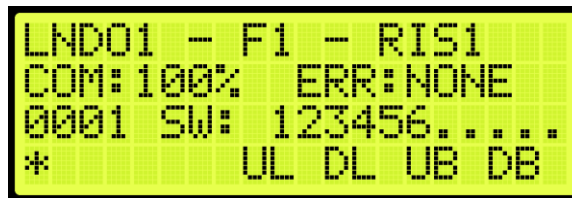

Figure 280: Hall Board Status

The Hall Board Status shows the following:

- Belongs to the first function range of Hall boards.
 - Connected to Riser board 1 in the machine room.
 - There are no errors.
 - Both up and down button are currently being pressed.
 - Both up and down lamps are currently lit.
3. The figure below shows an example of the status of an uninitialized Hall board.

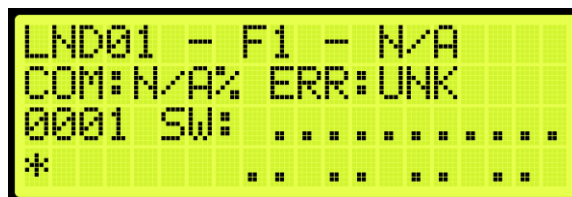

Figure 281: Uninitialized Hall Board Status

NOTE: once communication has been established with a Hall board and the communication is lost, the com status is 0% instead of N/A.

17.3 Enable Hall Security

When hall security is enabled, access to designated floors is restricted to authorized users.

The following procedure describes how to enable hall security.

1. Navigate to MAIN MENU | SETUP | GROUP SETUP (See Figure 61).
2. From the GROUP SETUP menu, scroll and select Enable Hall Security.



Figure 282: MISCELLANEOUS Menu – Enable Hall Security

3. From the ENABLE HALL SECURITY menu, scroll and select On to enable hall security.

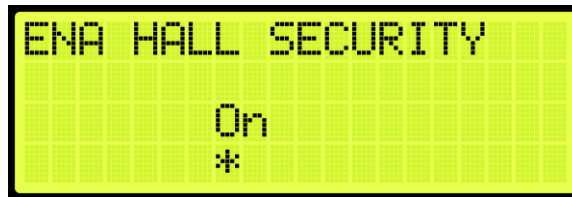

Figure 283: ENABLE HALL SECURITY Menu

4. Scroll right and press Save.

17.4 Hall Security Mask

The hall security mask marks what hall call masks require hall security contacts. Each bit corresponds to a different Hall board function ID. This mask is separated between front and rear masks (HSMF and HSMR) by the Hall Rear Door Mask (see Section 17.11 Hall Rear Door Mask. The hall security mask parameter is 08-0208. For the list of parameters, see the *Hydro:Evolved Parameter List*.

The following procedure describes how to set Hall Security Mask.

1. Navigate to MAIN MENU | SETUP | GROUP SETUP (See Figure 61).
2. From the GROUP SETUP menu, scroll and select Hall Security Mask.



Figure 284: GROUP SETUP Menu – Hall Security Mask

- From the HALL SECURITY MASK menu, scroll and turn ON the Hall board functions that need to be secured.

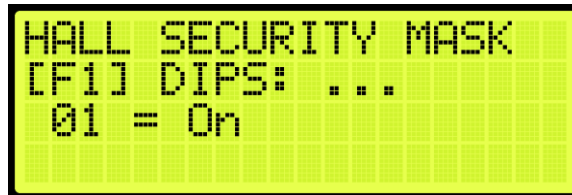

Figure 285: HALL SECURITY MASK Menu

- Scroll right and press Save.

17.5 Hall Security Map

The hall security map marks the landings that require hall security contacts. The configuration of the master group car (the car with the lowest group car ID) is used. However, all cars should share the same hall call security configuration parameters in case the master group car is taken offline. The front hall security map parameters are 16-0940 to 16-0945 and the rear hall security map parameters are 16-1035 to 16-1040. For the list of parameters, see the *Hydro:Evolved Parameter List*.

The following procedure describes how to set hall security map.

- Navigate to MAIN MENU | SETUP | GROUP SETUP (See Figure 61).
- From the GROUP SETUP menu, scroll and select Hall Security Map (Front or Rear).



Figure 286: GROUP SETUP Menu – Hall Security Map (Front or Rear)

- From the HALL SECURITY MAP menu, scroll and select the front or rear landings that require security access. Setting the landing to ON enables security for that landing.



Figure 287: HALL SECURITY MAP FRONT Menu

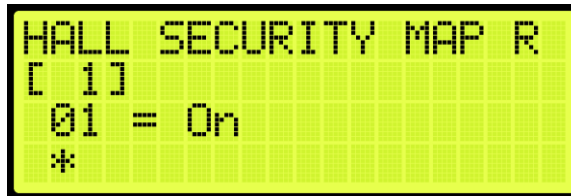

Figure 288: HALL SECURITY MAP REAR Menu

4. Scroll right and press Save.

17.6 Hall Security Status

The Hall Security status displays the status of the hall call security hall boards.

The following procedure describes how to view the Hall Security status.

1. Navigate to MAIN MENU | STATUS | HALL SECURITY STATUS (See Figure 49).
2. From the Hall Security menu, scroll up or down to view the floors that are set for hall security (See Figure 280).

17.7 Hall Call Mask

Hall call mask must be set to enable regular hall calls for a car. The hall call mask setting is located under address 08-0209 – 08-0212. The value for the address varies depending on the Function IDs of the Hall board installed. For the list of parameters, see the *Hydro:Evolved Parameter List*.

The following procedure describes how to set hall call mask.

1. Navigate to MAIN MENU | SETUP | GROUP SETUP (See Figure 61).
2. From the GROUP SETUP menu, scroll and select Hall Call Mask.



Figure 289: GROUP SETUP Menu – Hall Call Mask

- From the HALL CALL MASK menu, scroll and select if the function is enabled.



Figure 290: HALL CALL MASK Menu

- Scroll right and press Save.

To determine the value of the address, use the table below and add the corresponding values of each of the function IDs serviced by the car.

The table below lists the Hall board 10 DIP Hall Mask Mapping switch settings.

Table 30: Hall Board 10 DIP Hall Mask Mapping Switch Settings

DIP Switch 7-8-9	Function ID	Mask Value (Decimal)
OFF-OFF-OFF	1	1
ON-OFF-OFF	2	2
OFF-ON-OFF	3	4
ON-ON-OFF	4	8
OFF-OFF-ON	5	16
ON-OFF-ON	6	32
OFF-ON-ON	7	64
ON-ON-ON	8	128

The table below lists the Hall board 12 DIP Hall Mask Mapping switch settings.

Table 31: Hall board 12 DIP Hall Mask Mapping Switch Settings

DIP Switch 8-9-10	Function ID	Mask Value (Decimal)
OFF-OFF-OFF	1	1
ON-OFF-OFF	2	2
OFF-ON-OFF	3	4
ON-ON-OFF	4	8
OFF-OFF-ON	5	16
ON-OFF-ON	6	32
OFF-ON-ON	7	64
ON-ON-ON	8	128

17.8 Linked Hall Buttons

To get two sets of hall buttons to light up together, the paired hall mask parameter must be set. This parameter is set on each group car. This setting is located under address 08-0178. The value of the parameter varies the function IDs of the paired Hall boards. If additional pairings are required, addresses

08-0179 to 08-0181 are available for use. For the list of parameters, see the *Hydro:Evolved Parameter List*.

- **Example 1:** paired Hall boards with function ID 0 (DIP 7, DIP 8 and DIP 9 OFF) and function ID 2 (DIP 7 ON). Set 08-0178 to x03 (3 in decimal).
- **Example 2:** paired Hall boards with function ID 3 (DIP 8 ON) and function ID 4 (DIP 7 and DIP 8 ON). Set 08-0178 to x0C (12 in decimal).

The following procedure describes how to set linked hall mask.

1. Navigate to MAIN MENU | SETUP | GROUP SETUP (See Figure 61).
2. From the GROUP SETUP menu, scroll and select Linked Hall Mask.

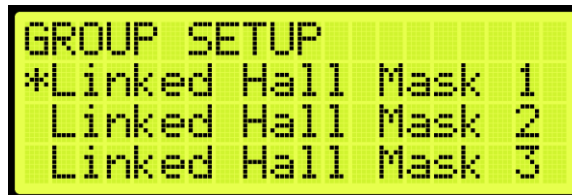

Figure 291: GROUP SETUP Menu – Linked Hall Mask

3. From the LINKED HALL MASK 1 menu, scroll and select the Hall boards within the group that are linked.

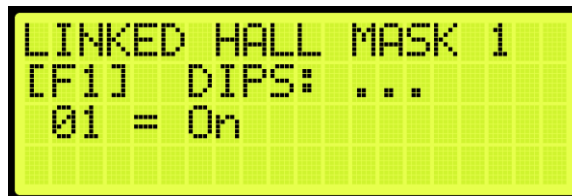

Figure 292: LINKED HALL MASK 1 Menu

4. Scroll right and press Save.

17.9 Hall Medical Mask

The Hall Medical Mask configures hall boards for emergency medical service calls. These calls put the nearest car on Emergency Medical Service mode of operation.

The following procedure describes how to set hall medical mask.

Consider two scenarios:

CASE I: the Hall Medical Rear Door Mask is not activated, and a front hall call is initiated from a medical floor with both front and rear openings, both front and rear doors will open.

CASE II: the Hall Medical Rear Door Mask is activated, and a front hall call is initiated from a medical floor with both front and rear openings, only the front door will open.

1. Navigate to MAIN MENU | SETUP | GROUP SETUP (See Figure 61).

2. From the GROUP SETUP menu, scroll and select Hall Medical Mask.



Figure 293: GROUP SETUP Menu – Hall Medical Mask

3. From the HALL MEDICAL MASK menu, scroll and select which cars are set for emergency service calls.

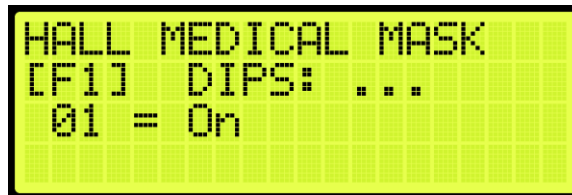

Figure 294: HALL MEDICAL MASK Menu

4. Scroll right and press Save.

17.10 Hall Medical Rear Door Mask

The Hall Medical Rear Door Mask configures hall boards for rear emergency medical service calls. These calls put the nearest car on Emergency Medical Service mode of operation.

The following procedure describes how to set hall medical mask.

Consider two scenarios:

CASE I: the Hall Medical Rear Door Mask is not activated, and a front hall call is initiated from a medical floor with both front and rear openings, both front and rear doors will open.

CASE II: the Hall Medical Rear Door Mask is activated, and a front hall call is initiated from a medical floor with both front and rear openings, only the front door will open.

1. Navigate to MAIN MENU | SETUP | GROUP SETUP (See Figure 61).
2. From the GROUP SETUP menu, scroll and select Hall Medical Rear Door Mask.



Figure 295: GROUP SETUP Menu – Hall Medical Rear Door Mask

3. From the HALL MEDICAL REAR DOOR MASK menu, scroll and select which cars are set for rear emergency service calls.

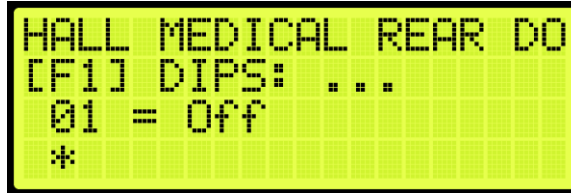

Figure 296: HALL MEDICAL REAR DOOR MASK Menu

4. Scroll right and press Save.

17.11 Hall Rear Door Mask

The hall rear door mask sets which hall boards function as rear door calls. Hall boards that are configured as rear door calls will be latched.

The following procedure describes how to set hall rear door mask.

1. Navigate to MAIN MENU | SETUP | GROUP SETUP (See Figure 61).
2. From the GROUP SETUP menu, scroll and select Hall Rear Door Mask.

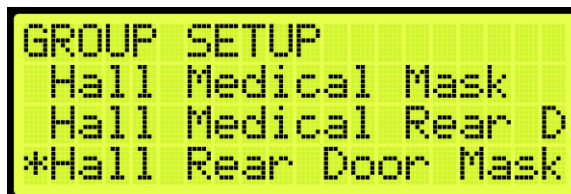

Figure 297: GROUP SETUP Menu – Hall Rear Door Mask

3. From the HALL REAR DOOR MASK menu, scroll and select hall calls that service landings where only the rear door opens.

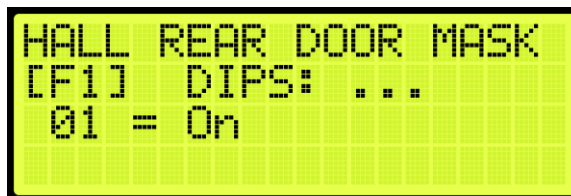

Figure 298: HALL REAR DOOR MASK Menu

4. Scroll right and press Save.

17.12 Split Group Masks

When a different Hall Mask and EMS Mask is required, the “Override Group Hall Mask” input should be activated. This will cause the cars within the group to split, allowing a different EMS mask and a different Hall Mask to be applied. The Override Group Hall Mask (08-0146) and the Override Group Medical Mask (08-0273) will replace the previously used Hall Call Mask (08-0209) and Hall Medical Mask (08-0210), respectively.

17.13 Errors

The following are possible errors that can occur:

- **UNK:** the board is uninitialized.
- **NONE:** the board has no errors.
- **POR:** the board is starting up.
- **WDT:** the board stalled and triggered a reset.
- **BOR:** the board power was insufficient and triggered a reset.
- **COM:** the board is not receiving commands.
- **DIP:** the board has the same address as another board on the network.
- **BUS:** the board is resetting its CAN transceiver.

17.14 Compatibility

The Hydro:Evolved Hall board and V2 Hall board are NOT compatible. The Hydro:Evolved Hall boards have 10 or 12 DIP switches (depending on the configuration), while the V2 Hall board has 8 DIP switches.

18 Serial Hall Lanterns

Serial Hall Lantern Hall boards, which are interchangeable with Hall Call boards, connect to the CAN network of the MR board. Since the Serial Hall Lantern Hall boards and the Hall Call boards share the same hardware and software, this manual references Hall boards.

18.1 CAN BUS

The Serial Hall Lantern Hall board CAN bus follows the same CAN bus guidelines as the Hall boards.

By default, the CAN network is terminated on the MR board so only terminate the lowest landings Serial Hall Lantern Hall board. If a CE Driver board is being used within the network, the termination on this board is removed.

18.2 Hall Lantern Masks

To enable hall lantern communications, the car’s hall lantern mask must be set. The setting is located under address 08-0213. The value for the address varies depending on the function IDs of the Serial Hall Lantern Hall boards installed. To determine the value of the address, use Table 30 or Table 31 and add the corresponding values of each of the Function IDs serviced by the car. See Section 5 Parameters to set the decimal format for Hall Lantern Masks.

To configure the Serial Hall Lantern Hall Call boards to serve as rear calls, set the rear hall lantern mask located under address 32-0036 to the corresponding value. Use the values in Table 30 to determine the value by adding the mask values of each of the function IDs that serve as rear calls. For the list of parameters, see the *Hydro:Evolved Parameter List*.

18.3 Serial Hall Lantern Status

If any issues occur with the Serial Hall Lantern Hall boards, start by checking the Hall Lantern status. The STATUS menu displays information about each board’s communication status, error state, I/O and DIP addressing.

The following procedure describes how to verify Hall Lantern status.

1. Navigate to MAIN MENU | STATUS | HALL LANTERN STATUS (See Figure 48)
2. The example below shows the status of the Hall Lantern.

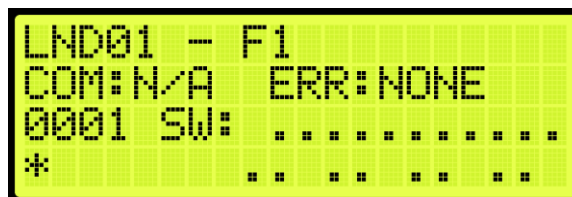

Figure 299: Hall Lantern Status

The figure below shows an example of the status of an uninitialized Hall Lantern Status.



Figure 300: Uninitialized Hall Lantern Status

18.4 Errors

For Hall Lantern Mask errors, see Section 17.12 Split Group Masks.

19 Hydro

Hydraulic elevators are powered by a piston that travels inside a cylinder. Electrical valves control the release of the oil which makes the car moves in either direction.

19.1 Valve Type Select

The valve type allows the user to select which type of valve is being used on the system.

The following procedure describes how to select the type of valve.

1. Navigate to MAIN MENU | SETUP | HYDRO (See Figure 63).
2. From the HYDRO SETUP menu, scroll and select Valve Type Select.

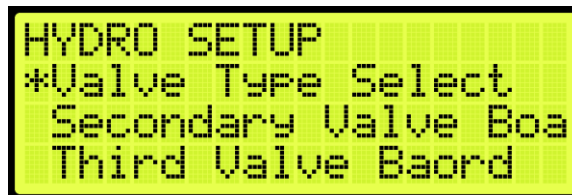

Figure 301: HYDRO SETUP Menu – Valve Type Select

3. From the VALVE TYPE SELECT menu, scroll and select the type of valve being used on the system.

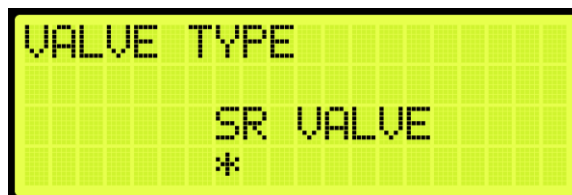

Figure 302: VALVE TYPE Menu

4. Scroll right and press Save.

19.2 Secondary Valve Board

A secondary valve can be used on the system for when there is a requirement for a high-capacity elevator which requires dual motors. Only the SR Valve type is supported for secondary valve control.

Perform the following procedure to enable the secondary Valve board.

1. Navigate to MAIN MENU | SETUP | HYDRO (See Figure 63).

2. From the HYDRO SETUP menu, scroll and select Secondary Valve Board.

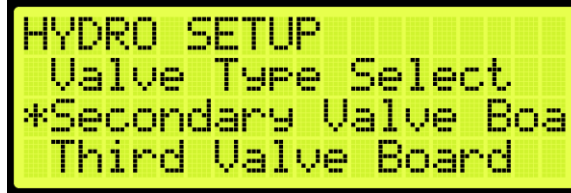

Figure 303: HYDRO SETUP Menu – Secondary Valve Board

3. From the SECONDARY VALVE BOARD menu, select ON to enable the Valve board.



Figure 304: SECONDARY VALVE BOARD Menu

4. Scroll right and press Save.

19.3 Third Valve Board

A third valve can be used on the system for when there is a requirement for a high-capacity elevator which requires triple motors. Only the SR Valve type is supported for third valve control.

Perform the following procedure to enable the third Valve board.

1. Navigate to MAIN MENU | SETUP | HYDRO (See Figure 63).
2. From the HYDRO SETUP menu, scroll and select Third Valve Board.

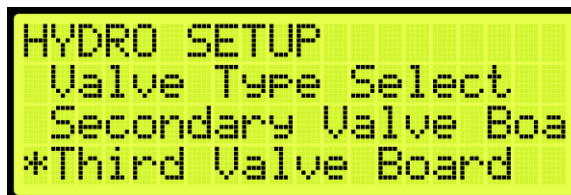

Figure 305: HYDRO SETUP Menu – Third Valve Board

3. From the THIRD VALVE BOARD menu, select ON to enable the Valve board.

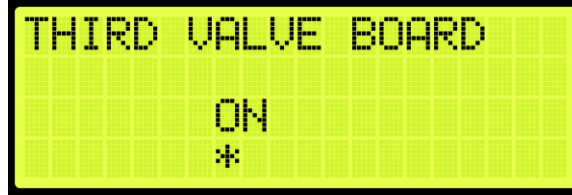

Figure 306: THIRD VALVE BOARD Menu

4. Scroll right and press Save.

19.4 Fourth Valve Board

A fourth valve can be used on the system for when there is a requirement for a high-capacity elevator which requires quadruple motors. Only the SR Valve type is supported for fourth valve control.

Perform the following procedure to enable the fourth Valve board.

1. Navigate to MAIN MENU | SETUP | HYDRO (See Figure 63).
2. From the HYDRO SETUP menu, scroll and select Fourth Valve Board.



Figure 307: HYDRO SETUP Menu – Fourth Valve Board

3. From the FOURTH VALVE BOARD menu, select ON to enable the Valve board.

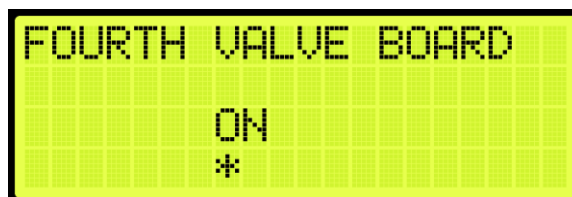

Figure 308: FOURTH VALVE BOARD Menu

4. Scroll right and press Save.

19.5 Soft Starter

A soft starter provides phase, over-voltage, and under-voltage protection. This protection helps prevent the motor during phase loss and enhances motor life.

19.5.1 Primary

The primary soft starter must have the ramp up, over voltage, over current, over temperature configured.

19.5.1.1 Ramp Up Time

The ramp up time is the time it takes for the primary soft starter to ramp up to full voltage that eventually increases the amount of current applied to the motor to reduce torque.

The following procedure describes how to set the soft starter ramp up time.

1. Navigate to MAIN MENU | SETUP | HYDRO C
2. From the HYDRO SETUP menu, scroll and select Soft Starter.



Figure 309: HYDRO SETUP – Soft Starter

3. From the SOFT STARTER menu, scroll and select Primary.



Figure 310: SOFT STARTER Menu – Primary

4. From the PRIMARY menu, scroll and select Ramp Up Time.

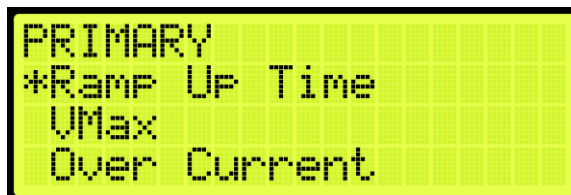

Figure 311: PRIMARY Menu – Ramp Up Time

- From the RAMP UP TIME menu, set the time for the soft starter to ramp up to full voltage.



Figure 312: RAMP UP TIME Menu

- Scroll right and press Save.

19.5.1.2 Vmax

Maximum voltage is the percentage of voltage that is allowed to limit the amount of current and torque to the motor.

The following procedure describes how to set the maximum voltage.

- Navigate to MAIN MENU | SETUP | HYDRO (See Figure 63).
- From the HYDRO SETUP menu, scroll and select Soft Starter (See Figure 309)
- From the SOFT STARTER menu, scroll and select Primary (See Figure 310).
- From the PRIMARY menu, scroll and select Vmax.

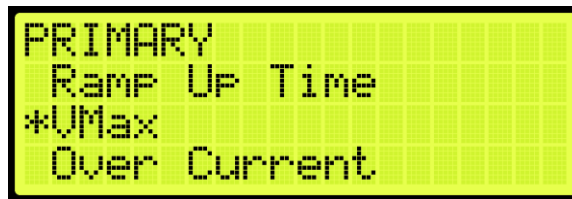

Figure 313: PRIMARY Menu – Vmax

- From the VMAX AC VOLTAGE menu, set the percentage of the maximum voltage.



Figure 314: VMAX AC VOLTAGE Menu

- Scroll right and press Save.

19.5.1.3 Over Current

Current limitations are set to prevent the motor from overheating. See the manufacturers *Soft Starter User Manual* for more information.

The following procedure describes how to set the overcurrent limit.

1. Navigate to MAIN MENU | SETUP | HYDRO (See Figure 63).
2. From the HYDRO SETUP menu, scroll and select Soft Starter (See Figure 309).
3. From the SOFT STARTER menu, scroll and select Primary (See Figure 310).
4. From the PRIMARY menu, scroll and select Over Current.

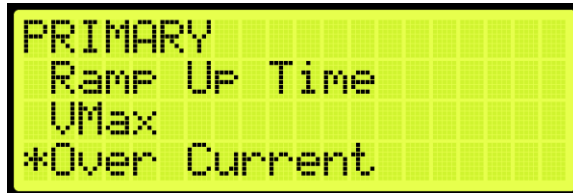

Figure 315: PRIMARY Menu – Over Current

5. From the OVERCURRENT menu, enter the maximum current allowed.

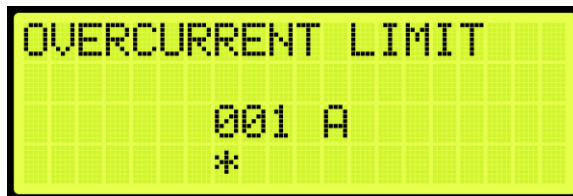

Figure 316: OVERCURRENT Menu

6. Scroll right and press Save.

19.5.1.4 Over Temperature

When an over temperature condition occurs, the soft starter goes into recovery mode. This will in turn shut down the motor to prevent internal damage to the motor.

The following procedure describes how to set the over temperature limit.

1. Navigate to MAIN MENU | SETUP | HYDRO (See Figure 63).
2. From the HYDRO SETUP menu, scroll and select Soft Starter (See Figure 309).
3. From the SOFT STARTER menu, scroll and select Primary (See Figure 310).
4. From the PRIMARY menu, scroll and select Over Temperature.

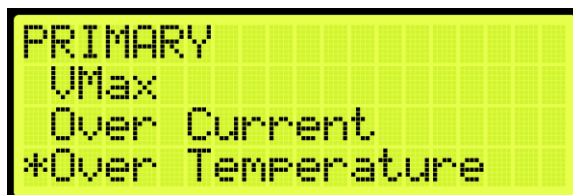

Figure 317: PRIMARY Menu – Over Temperature

- From the OVERTEMPERATURE LIMIT menu, enter the maximum temperature.

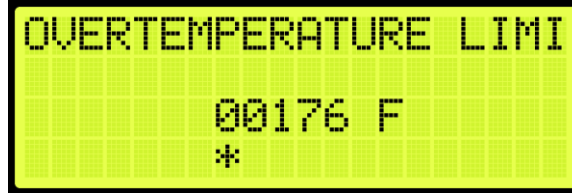

Figure 318: OVERTEMPERATURE LIMIT Menu

- Scroll right and press Save.

19.5.2 Secondary

If a secondary soft starter is available, the soft starter must be configured.

19.5.2.1 Enable Secondary

When enabled, the secondary soft starter is used when a dual motor is required to lift a car with a high-capacity load.

The following procedure describes how to enable the secondary soft starter.

- Navigate to MAIN MENU | SETUP | HYDRO (See Figure 63).
- From the HYDRO SETUP menu, scroll and select Soft Starter (See Figure 309).
- From the SOFT STARTER menu, scroll and select Secondary.



Figure 319: SOFT STARTER Menu – Secondary

- From the SECONDARY menu, scroll and select Enable Secondary.



Figure 320: SECONDARY Menu – Enable Secondary

- From the ENABLE SECONDARY SOFT STARTER menu, select ON to enable the secondary soft starter.

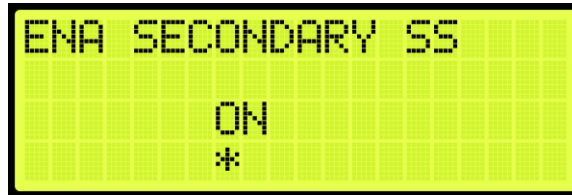

Figure 321: ENABLE SECONDARY SOFT STARTER Menu

- Scroll right and press Save.

19.5.2.2 Ramp Up Time

The ramp up time is the time it takes for the secondary soft starter to ramp up to full voltage, that eventually increases the amount of current applied to the motor to reduce torque.

The following procedure describes how to set the soft starter ramp up time.

- Navigate to MAIN MENU | SETUP | HYDRO (See Figure 63).
- From the HYDRO SETUP menu, scroll and select Soft Starter (See Figure 309).
- From the SOFT STARTER menu, scroll and select Secondary (See Figure 319).
- From the SECONDARY menu, scroll and select Ramp Up Time.



Figure 322: SECONDARY Menu – Ramp Up Time

- From the RAMP UP TIME menu, set the time for the soft starter to ramp up to full voltage (See Figure 312).
- Scroll right and press Save.

19.5.2.3 Vmax

Maximum voltage is the percentage of voltage that is allowed to limit the amount of current and torque to the motor for the secondary soft starter.

The following procedure describes how to set the maximum voltage.

- Navigate to MAIN MENU | SETUP | HYDRO (See Figure 63).
- From the HYDRO SETUP menu, scroll and select Soft Starter (See Figure 309).
- From the SOFT STARTER menu, scroll and select Secondary (See Figure 319).

4. From the SECONDARY menu, scroll and select Vmax.



Figure 323: SECONDARY Menu – VMax

5. From the VMAX AC VOLTAGE menu, set the percentage of the maximum voltage (See Figure 314).
6. Scroll right and press Save.

19.5.2.4 Over Current

Current limitations for the secondary soft starter are set to prevent the motor from overheating. See the manufacturers *Soft Starter User Manual* for more information.

The following procedure describes how to set the overcurrent limit.

1. Navigate to MAIN MENU | SETUP | HYDRO (See Figure 63).
2. From the HYDRO SETUP menu, scroll and select Soft Starter (See Figure 309).
3. From the SOFT STARTER menu, scroll and select Secondary (See Figure 319).
4. From the SECONDARY menu, scroll and select Over Current.

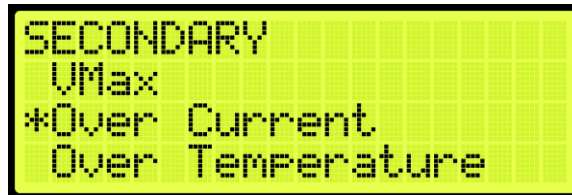

Figure 324: SECONDARY Menu – Over Current

5. From the OVERCURRENT menu, enter the maximum current allowed (See Figure 316).
6. Scroll right and press Save.

19.5.2.5 Over Temperature

When an over temperature condition occurs in the secondary soft starter, the soft starter goes into recovery mode. This will in turn shut down the motor to prevent internal damage to the motor.

The following procedure describes how to set the over temperature limit.

1. Navigate to MAIN MENU | SETUP | HYDRO (See Figure 63).
2. From the HYDRO SETUP menu, scroll and select Soft Starter (See Figure 309).
3. From the SOFT STARTER menu, scroll and select Secondary (See Figure 319).

4. From the SECONDARY menu, scroll and select Over Temperature.

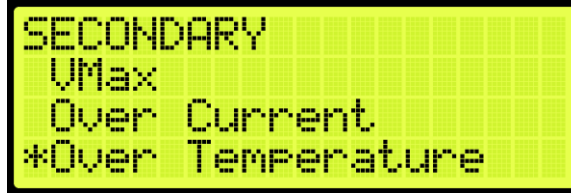

Figure 325: SECONDARY Menu – Over Temperature

5. From the OVERTEMPERATURE LIMIT menu, enter the maximum temperature (See Figure 318).
6. Scroll right and press Save.

19.5.3 Third

If a third soft starter is available, the soft starter must be configured.

19.5.3.1 Enable Third

When enabled, the third soft starter is used when a triple motor is required to lift a car with a high-capacity load.

The following procedure describes how to enable the third soft starter.

1. Navigate to MAIN MENU | SETUP | HYDRO (See Figure 63).
2. From the HYDRO SETUP menu, scroll and select Soft Starter (See Figure 309).
3. From the SOFT STARTER menu, scroll and select Third.



Figure 326: SOFT STARTER Menu – Third

4. From the THIRD menu, scroll and select Enable Third.

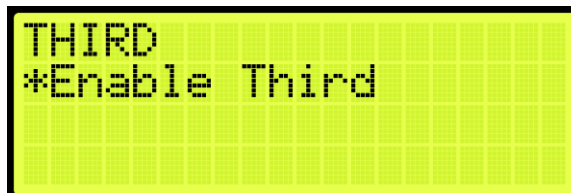

Figure 327: THIRD Menu – Enable Third

- From the ENABLE THIRD SOFT STARTER menu, select ON to enable the third soft starter.



Figure 328: ENABLE THIRD SOFT STARTER Menu

- Scroll right and press Save.

19.5.4 Run With One Soft Starter

When a particular job supports more than one soft starter, and this parameter is ON, the car will be allowed to run even if one of the soft starters is faulted, only if the faults are not soft starter specific. In this situation, soft starter faults will instead be asserted as alarms. This option is only available if the secondary or third soft starter is enabled.

The following procedure describes how to run the elevator with one soft starter.

- Navigate to MAIN MENU | SETUP | HYDRO (See Figure 63).
- From the HYDRO SETUP menu, scroll and select Soft Starter (See Figure 309).
- From the SOFT STARTER menu, scroll and select Run With One Soft Starter.

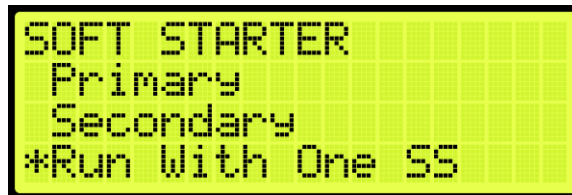

Figure 329: SOFT STARTER Menu – Run With One Soft Starter

- From RUN WITH ONE SOFT STARTER menu, select ON to run with only one soft starter.



Figure 330: Run With One Soft Starter Menu

- Scroll right and press Save.

19.6 Slowdown

Several peripherals affect the acceleration rate, deceleration rate, and speed of the car in the up or down direction which includes, the temperature and viscosity of the oil, and weight.

Once all faults and alarms have been resolved during Construction and Inspection Mode, place the DZ magnet 2” above the floor level for the bottom floor and 2” below the floor level for the top floor. This creates an extra precaution for the car not to hit the ring buffer while travelling in up direction and car buffer when traveling in down direction to avoid any unexpected scenarios.

For proper operation, the controller and valves must be configured so the car has the proper acceleration and slowdown time.

For a better/faster performance, the acceleration time should be less than 1 second.

If the deceleration rate of the car is slow and the car hits the Terminal Stopping Distance (TSRD), reduce the deceleration rate of the valve (transition rate from High valve to Leveling valve).

The following is a graphical image of the parameters that are being adjusted.

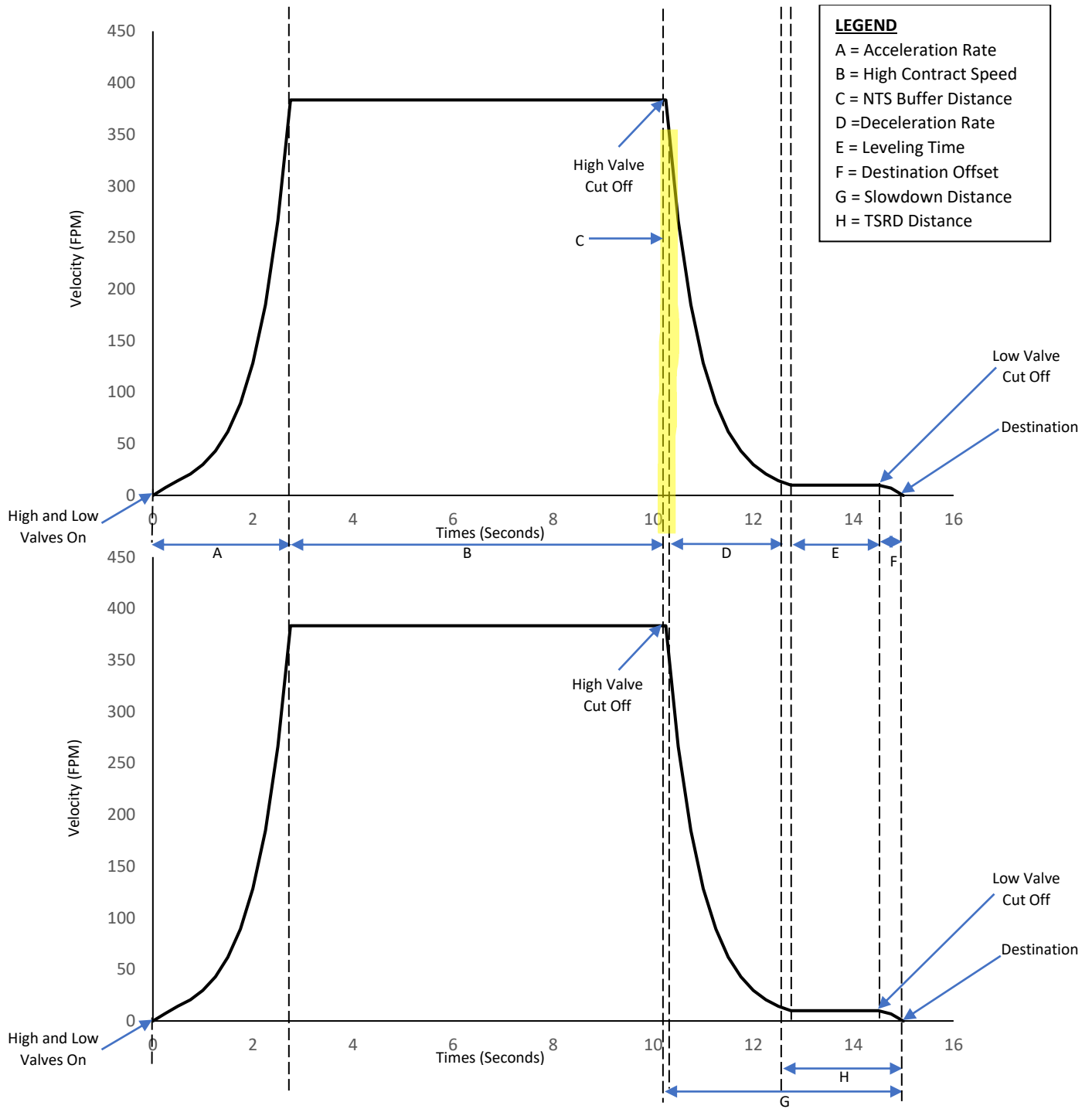

Figure 331: Slowdown Distance

- A. **Acceleration Rate** - Rate at which the car accelerates before reaching maximum speed.
- B. **High Contract Speed** - The maximum speed the car will achieve based on the contract speed setting and the high valve setting.
- C. **NTS Buffer Distance**: The distance added to the slowdown distance to cut off the high valves.
- D. **Deceleration Rate** - Rate at which the car decelerates after it reaches maximum speed.
- E. **Leveling Time** - The duration the car moves during level speed before reaching the destination.
- F. **Destination Offset** - The distance from the destination position that the car will cut its leveling valve when moving on a non-releveling run/correction run.
- G. **Slowdown Distance** - Sets the distance from its destination where the car must cut its high-speed valves when moving at a speed above the speed threshold.
- H. **TSRD Distance** - The safe distance from the top and bottom floor level for a car to stop before it hits the buffer. If the car is traveling more than 50 fpm within this distance, a TSRD fault occurs and the car performs an emergency stop.

Place the car in Normal Operation. Prior to learning the hoistway verify the number of floors and openings are correct. Learning the hoistway allows for learning the positioning of all floors.

19.6.1 Level Maximum Run Distance

Set the maximum run distance where level valve speed run is allowed. Longer runs outside of door zones may start with a higher speed valve. When set to zero, a short distance run will start with the higher valve and have a high likelihood of overshooting the destination.

The following procedure describes how to set the level maximum run distance.

1. Navigate to MAIN MENU | SETUP | HYDRO (See Figure 63).
2. From the HYDRO SETUP menu, scroll and select Level Maximum Run Distance.

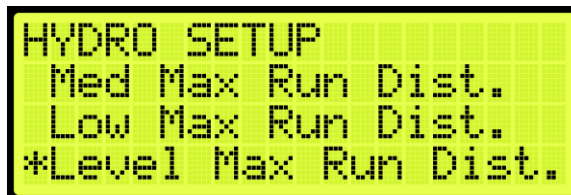

Figure 332: HYDRO SETUP Menu – Level Maximum Run Distance

3. From LEVEL MAXIMUM RUN DISTANCE menu, enter the maximum run distance.



Figure 333: LEVEL MAXIMUM RUN DISTANCE Menu

4. Scroll right and press Save.

19.6.2 NTS Buffer Distance Up and Down

An NTS alarm may be generated in any direction during normal mode of operation. When this occurs, the NTS buffer distance needs to be increased.

The following procedure describes how to set the NTS buffer distance up and down.

1. Navigate to MAIN MENU | SETUP | HYDRO (See Figure 63).
2. From the HYDRO SETUP menu, scroll and select NTS Buffer Distance Up or NTS Buffer Distance Down.



Figure 334: HYDRO SETUP Menu – NTS Buffer Distance Up or Down

3. From the NTS BUFFER DISTANCE UP or NTS BUFFER DISTANCE DOWN menu, enter the buffer distance.



Figure 335: NTS BUFFER DISTANCE UP Menu

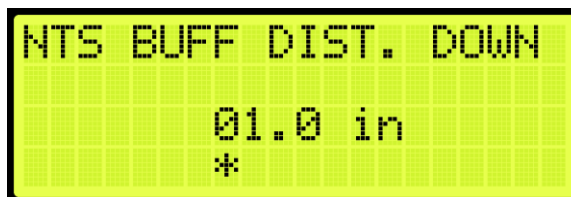

Figure 336: NTS BUFFER DISTANCE DOWN Menu

4. Scroll right and press Save.

19.6.3 Destination and Relevel Offsets

There is some delay at the end of a run between cutting the leveling speed valve and the coming to a stop. By default, the user may see the car overshoot its destinations and relevel back. To address this situation, the car's destination offset has to be adjusted. The offset destinations cause the car to stop its run shy of the ON position in order to compensate for the movement that occurs after the leveling valve is cut.

19.6.3.1 Destination Offset

The destination offset determines when to cut the leveling valves, when the car is leveling towards the destination landing. This is the sliding distance after the leveling valves are cut and the car comes to a stop to the destination landing.

If the car has a proper steady state leveling time but still overshoots the learned floor position and stops outside the dead zone and relevels, set the destination offset up or destination offset down depending on which direction the car is moving.

Perform the following procedure to set the up or down offset.

1. Navigate to MAIN MENU | SETUP | HYDRO (See Figure 63).
2. From the HYDRO SETUP menu, scroll and Destination Offset Up or Down. The values are set after determining how far the cars have overshoot the landing.

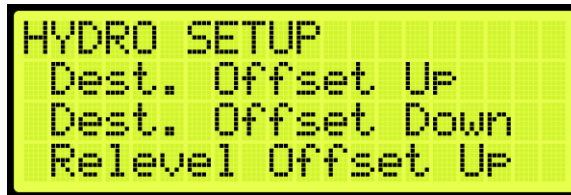

Figure 337: HYDRO SETUP Menu – Destination Offset (Up or Down)

3. Does the car stop outside the dead zone?
 - i. If the car is moving in up direction and stops outside the dead zone, got to step 4.
 - ii. If the car is moving in down direction and stops outside the dead zone, go to step 5.
4. Increase the up offset by 0.5in. Go to step 6.



Figure 338: DESTINATION OFFSET UP Menu

5. Increase the down offset by 0.5in.



Figure 339: DESTINATION OFFSET Down Menu

6. Scroll right and press Save.

19.6.3.2 Relevel Offset

Relevel Offset is the distance from the destination position that the car cuts its leveling valve when moving in the up or down direction on a releveling run.

Perform the following procedure to set the up or down offset.

1. Navigate to MAIN MENU | SETUP | HYDRO (See Figure 63).
2. From the HYDRO SETUP menu, scroll and Relevel Offset Up or Down. The values are set after determining how far the cars have overshot the landing.

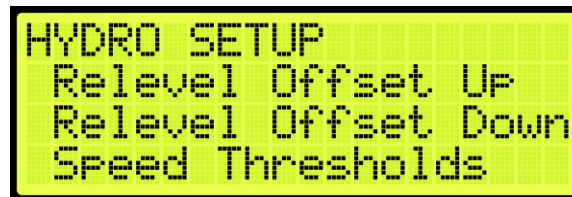

Figure 340: HYDRO SETUP Menu – Relevel Offset (Up or Down)

3. From the RELEVEL OFFSET UP or RELEVEL OFFSET DOWN menu, enter the offset. The values are set after determining how far the cars have overshot the landing.



Figure 341: RELEVEL OFFSET UP Menu



Figure 342: Relevel Offset Down Menu

4. Scroll right and press Save.

19.6.4 Speed Thresholds

The speed threshold is compared to the current speed to determine the slowdown distance used to reach the destination. This distance determines when to slow the car in either the up or down direction.

The following procedure describes how to set the speed threshold.

1. Navigate to MAIN MENU | SETUP | HYDRO (See Figure 63).
2. From the HYDRO SETUP menu, scroll and select Speed Thresholds



Figure 343: HYDRO SETUP Menu – Speed Thresholds

3. From the SPEED THRESHOLD menu, scroll and select the slowdown distance.



Figure 344: SPEED THRESHOLD Menu

4. Scroll right and press Save.

19.6.5 Slowdown Distance

The slowdown distance is the distance in which the car transitions from high speed to leveling speed in the up or down direction. If adjusting the Slowdown Distance when weights are added to the car, see section 19.6.8.3 Monitoring Adaptive Slowdown™ system (U.S. Patent Pending).

The actual slowdown average distances can be monitored by navigating to MAIN MENU | DEBUG | VIEW DEBUG DATA |, Indexes 070 (UP) and 071 (DN).

These displays are updated at the end of each run. The Up distance average appears under index 070. The Down distance average appears under index 071.

These distances will increase after TSRD or NTS events.

NOTE: if the distances are not stable, the car may be experiencing NTS alarms at the terminal landings. Check the Leveling Time distances. If the average distances on the Debug Data screens drop too far below the Leveling Time distances, the system may trigger NTS alarms. To correct this, either decrease the Leveling Time setting or increase the NTS timeout via MAIN MENU | SAFETY | NTS ODL.

19.6.6 Slowdown Distance After Adjustments

The following procedure describes how to set the slowdown distance.

1. Navigate to MAIN MENU | SETUP | HYDRO (See Figure 63).
2. From the HYDRO SETUP menu, scroll and select Slowdown Distance UP or DOWN.

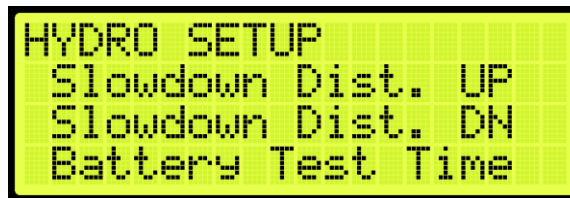

Figure 345: HYDRO SETUP Menu – Slowdown Distance UP or DOWN

3. From the SLOWDOWN DISTANCE UP or SLOWDOWN DISTANCE DOWN menu, scroll and select the slowdown distance.



Figure 346: SLOWDOWN DISTANCE UP Menu



Figure 347: SLOWDOWN DISTANCE DOWN Menu

4. Scroll right and press Save.

19.6.7 Hydro Speed Setup

The Hydro Speed Setup takes the slowdown factor of the distance and time relative to the speed to generate the slowdown distances and threshold for each landing. The up and down adjustments depend upon the selected factor in which the greater the factor the greater the distance.

For Example: if the factor is 1 second, the slowdown distance will be 2' 1", whereas if the factor is 1.78 seconds, the slowdown distance will be 3' 8". Depending on the high speed and type of valve setup, the factor can be determined.

To have a proper slowdown for up or down direction, adjust the up and down time.

NOTE: changes made on Up Adjustment and Down Adjustment will not take effect while Adaptive Slowdown™ system (U.S. Patent Pending) is active - turn off Adaptive Slowdown™ system (U.S. Patent Pending) before proceeding.

1. Navigate to MAIN MENU | SETUP | HYDRO | HYDRO SPEED SETUP | UP and DOWN ADJUSTMENT (need to set both).

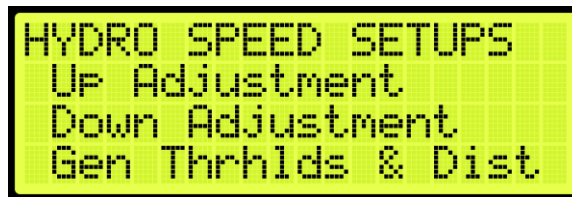

Figure 348: HYDRO SETUP Menu – Hydro Speed Setup

2. From the Up Distance or Down Distance menu, select the time for which the car is expected to transition from high speed to low speed.



Figure 349: Up Distance Menu



Figure 350: Down Distance Menu

3. Scroll back to GENERATE THRESHOLDS AND DISTANCES and select YES. If YES is not selected, new thresholds and slowdowns are not generated.



Figure 351: GENERATE THRESHOLDS AND SLOWDOWNS? Menu

4. Selecting yes will generate the values for slowdown distance up, slow down distance down, and threshold.
 - i. if overshooting occurs, following instructions under Section 19.6.7.1 Car Overshooting and repeat steps 1-4.
 - ii. If leveling time is too long or short, follow instructions under Section 19.6.7.2 Adjust Leveling Time and repeat steps 1-4.

19.6.7.1 Car Overshooting

Overshooting is where the car goes beyond floor level. To prevent overshooting, increase the time. This causes the car to slow down sooner which increases the slowdown distance.

The following procedure describes how to resolve car steady state if overshooting occurs:

1. Navigate to MAIN MENU | SETUP | HYDRO | HYDRO SPEED SETUP | UP and DOWN ADJUSTMENT (need to set both).
2. Adjust the up or down distance by increasing the time. Increasing the time causes the car to slow down sooner which increases the slowdown distance.

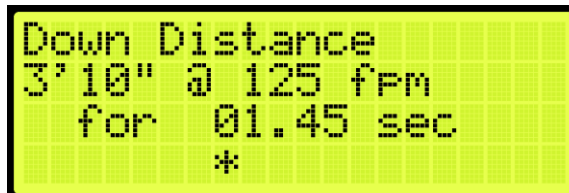

Figure 352: Down Distance Menu – Overshooting Adjustment

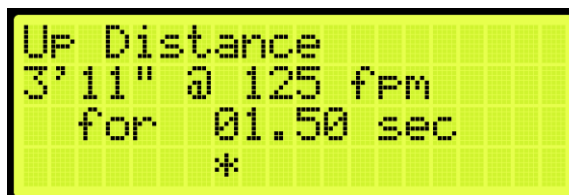

Figure 353: Up Distance Menu – Overshooting Adjustment

3. Scroll back to GENERATE THRESHOLDS AND DISTANCES and select YES. If YES is not selected, new thresholds and slowdowns are not generated.



Figure 354: GENERATE THRESHOLDS AND SLOWDOWNS? Menu

19.6.7.2 Adjust Leveling Time

When weight is added to the car, it might take longer than normal (three to five seconds) for the car to level. Decreasing the slowdown distance decreases the time it takes for the car to level. The speed threshold to adjust is dependent upon the speed the car is traveling.

The following procedure describes how to resolve car steady state if leveling is longer:

1. Navigate to MAIN MENU | SETUP | HYDRO | HYDRO SPEED SETUP | UP and DOWN ADJUSTMENT (need to set both).
2. Adjust the up or down distance by decreasing the time.
3. Decreasing the time causes the car to have a shorter slow down period which decreases the slowdown distance.



Figure 355: Down Distance Menu – Steady State of Leveling Longer Adjustment



Figure 356: Up Distance Menu – Steady State of Leveling Longer Adjustment

4. Scroll back to GENERATE THRESHOLDS AND DISTANCES and select YES. If YES is not selected, new thresholds and slowdowns are not generated.



Figure 357: GENERATE THRESHOLDS AND SLOWDOWNS? Menu

19.6.8 Adaptive Slowdown™ system (U.S. Patent Pending)

The following feature operates on top of the Hydro Evolved Setup Slowdown Distance instructions. When active, the Adaptive Slowdown™ system (U.S. Patent Pending) monitors the operation of each run. After each run, the software adjusts a reference slowdown distance variable based on previous runs so that subsequent runs result in leveling times closer to the target Leveling Time selected. Run-to-run variances in elevator operations will not have a significant effect on the reference slowdown distance.

19.6.8.1 Procedure

Complete the following steps after successfully setting the adjusted slow down distance:

1. Measure the Leveling Time from when the car reaches the level speed until the car stops. The measured Leveling Time will be used as the base line for the Target Time used in step 2.
2. Navigate to MAIN MENU | SETUP | HYDRO | ADAPTIVE SLOWDOWN™ SYSTEM (U.S. PATENT PENDING) | LEVELING TARGET.
3. Set the Slowdown Target Time to the measured time on step 1 then select save.



Figure 358: LEVELING TARGET Menu – Slowdown Target

4. Navigate to MAIN MENU | SETUP | HYDRO | ADAPTIVE SLOWDOWN™ SYSTEM (U.S. PATENT PENDING) | ENABLE SLOWDOWN.
5. Set to ON.



Figure 359: ENABLE SLOWDOWN Menu – Slowdown Learn

6. Allow the car to run from Floor to Floor for 2 full cycles to adjust the slowdown distance. It is recommended to run the car empty during the first 2 cycles to allow the car to measure the slowdown distance accurately.

19.6.8.2 Troubleshoot Adaptive Slowdown™ system (U.S. Patent Pending)

The following steps are used to troubleshoot the car based on different occurrences:

- **The car is overshooting the landing:** overshooting occurs if the leveling time is set too short to allow for the weight fluctuation in slowdown distance, then car will take a significant step back by increasing the slowdown distance. The Adaptive Slowdown™ system (U.S. Patent Pending) will decrease the distance until an overshoot occurs.
 - Increase the Target Time in increments of .5 seconds and repeat step 4 of the procedure.



Figure 360: Slowdown Target- Increase

- **Car is taking too long arriving to the landing:** the car will decrease the leveling time in increments of .1 seconds based on the initial Hydro Speed Setup until the Target Time on Adaptive Slowdown™ system (U.S. Patent Pending) is met and will continue to fluctuate between the range. Decreasing the range will decrease the fluctuation of the learning distance.
 - Decrease the Target Time in increments of .5 seconds and repeat step 4 of the procedure.



Figure 361: Slowdown Target- Decrease

- **The car is misaligned with the landing:** the car is at the door zone, but slightly above or below the landing.
 - Follow instructions on the for Floor Adjustment to adjust the floor height to align the car with the landing.
- **Car is getting a TSRD fault when you are reaching the landing:** fault occurs when the range of the TSRD distance to the landing is too high for the Slow Down Distance.
 - Navigate to MAIN MENU | SETUP | HYDRO | TSRD DISTANCE



Figure 362: HYDRO SETUP-TSRD Distance

- Decrease the TSRD Distance to a lower value and repeat step 4 of the procedure.

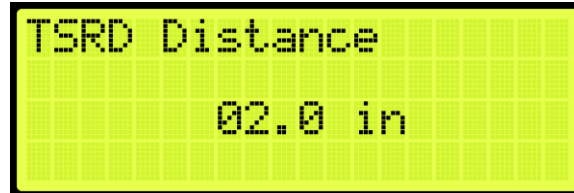

Figure 363: TSRD Distance

19.6.8.3 Monitoring Adaptive Slowdown™ system (U.S. Patent Pending)

The actual slowdown average distances can be monitored by navigating to MAIN MENU | DEBUG | VIEW DEBUG DATA | Indexes 070 (UP) and 071 (DN).

These displays are updated at the end of each run. The Up distance average appears under index 070. The Down distance average appears under index 071.

These distances will increase after TSRD or NTS events.

NOTE: if the distances are not stable, the car may be experiencing NTS alarms at the terminal landings. Check the Leveling Time distances. If the average distances on the Debug Data screens drop too far below the Leveling Time distances, the system may trigger NTS alarms. To correct this either decrease the Leveling Time setting or increase the NTS timeout via MAIN MENU | SAFETY | NTS ODL.

19.6.9 Slowdown Distance After Adjustments

Once the initial setup has been completed for an empty car, weights must be added to verify leveling under a full load.

The same settings for the slowdown distance and speed of an empty car are used with a car which has various amounts of load added until the car is fully loaded.

To verify the slowdown distance and speed of a car with a load, add a 500-pound load to the car. Place a car call for one floor and a multi floor run in both directions. Observe if the car overshoots and relevels or has a long leveling time. If the valves are not regulated, the deceleration rate or the steady state of leveling are affected. The deceleration rate will increase or the leveling speed will decrease as the weight of the car increases.

There are three conditions which can occur while adding weights:

- If the car overshoots, increase the slowdown distance.

- If the leveling time is too long, decrease the slowdown distance. I
- If the valves are not regulated and leveling time is longer, do not change the slowdown distance.

DO NOT generate the threshold and distance after fine tuning the slowdown distance. This will override the fine-tuning values and generate new slowdowns depending on the factor in the up/down adjustments.

For fine tuning the slow down distance, observe what is the maximum speed of the car before it starts slowing down.

The following procedure describes how to view maximum speed of the car.

1. Navigate to MAIN MENU | SETUP | HYDRO (See Figure 63).
2. From the HYDRO SETUP menu, scroll and select Slowdown Distance UP or DOWN (See Figure 345).
3. Due to multiple speed thresholds and slowdown distances, select the slowdown distance for the speed the car is running at.



Figure 364: View Slowdown Distance Up



Figure 365: View Slowdown Distance Down

If adjusting the car for a different threshold with weights added and the car is overshooting or the leveling time is greater than the empty car, increase or decrease the slowdown distance.

There are seven speed thresholds and slowdown distances. Select the correct speed threshold to adjust so the speed of the car matches high speed.

19.6.9.1 Overshooting

The slowdown distance is dependent upon the speed of the car. As more weight is added to the car, the speed and the slow down time of the car may decrease. If the car overshoots, the slow down distance needs to increase to give the car more time to slow down. If the valves are regulated, the speed of the car may not change.

The following procedure describes how to resolve car overshooting.

1. Navigate to MAIN MENU | SETUP | HYDRO (See Figure 63).
2. From the HYDRO SETUP menu, scroll and select Slowdown Distance Up (See Figure 345).
3. Select the slowdown distance for the speed the car is running at. Scroll to find the correct slowdown distance to adjust (See Figure 346).
4. The high speed of the car must be less than the speed threshold. For example, after adding weights the high speed of the car is 100 fpm, select the speed threshold with speed of 105 fpm.
5. Increase the slowdown distance up from 2' 09" to 3' 02". Place a car calls in up direction and see if the car still overshoots the floor. Repeat these steps if the car still overshoots the floor.



Figure 366: SLOWDOWN DISTANCE UP – Adjustment

6. Scroll right and press Save.

Continue adding a load to the car and verifying the slowdowns until the car is fully loaded.

19.6.9.2 Steady State of Leveling is Longer

When weight is added to the car, it might take longer than normal for the car to level. Decreasing the slowdown distance decreases the time it takes for the car to level. The speed threshold too adjust is dependent upon the speed the car is traveling.

The following procedure describes how to resolve car steady state of leveling is longer.

1. Navigate to MAIN MENU | SETUP | HYDRO (See Figure 63).
2. From the HYDRO SETUP menu, scroll and select Slowdown Distance Down (See Figure 345).
3. Select the slowdown distance for the speed the car is running at. Scroll to find the correct slowdown distance to adjust (See Figure 347).
4. The high speed of the car must be less than the speed threshold. For example, after adding weights the high speed of the car is 100 fpm, select the speed threshold with speed of 105 fpm.
5. Decrease the slowdown distance up from 3' 06" to 2' 09". Place a car calls in down direction and see if the car still has longer steady state of leveling to the floor. Repeat these steps, if the car still has longer steady state of leveling to the floor.



Figure 367: SLOWDOWN DISTANCE DOWN – Adjustment

Continue adding a load to the car and verifying the slowdowns until the car is fully loaded.

19.6.10 TSRD Distance

The TSRD is the safe distance from the top and bottom floor level for a car to stop before it hits the ring buffer in the up direction and the buffer in the down direction. If the car is traveling for more than 50 fpm within this distance, a TSRD fault occurs and the car performs an emergency stop.

The following procedure describes how to set the TSRD Distance from the learned position.

1. Navigate to MAIN MENU | SETUP | HYDRO (See Figure 63).
2. From the HYDRO SETUP menu, scroll and select TSRD Distance.

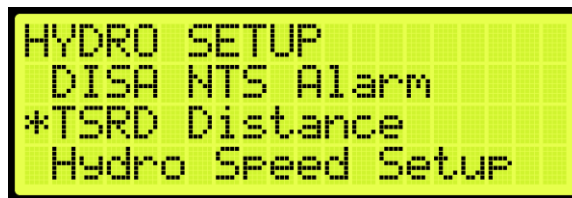

Figure 368: HYDRO SETUP Menu – TSRD Distance

3. From the TSRD Distance menu, set the distance.



Figure 369: TSRD Distance Menu

19.7 Battery Test Time

The battery test time is the time of day the controller searches for a battery fault signal and creates an emergency battery fault if the fault occurs for three consecutive days.

The following procedure describes how to set the time the batteries.

1. Navigate to MAIN MENU | SETUP | HYDRO (See Figure 63).
2. From the HYDRO SETUP menu, scroll and select Battery Test Time.



Figure 370: HYDRO SETUP Menu – Battery Test Time

3. From the BATTERY TEST TIME menu, enter the time the controller searches for a battery fault.



Figure 371: Battery Test Time Menu

4. Scroll right and press Save.

19.8 Jack Resync Time

Jack resync is required for hydro elevators that have dual jacks. Over time, the jacks can get out of sync, causing one to be higher than the other and making the car off level. A resync operation is done to remove all the oil from both jack cylinders which synchronizes the plungers back to the same level.

This is normally done as a timed operation. The mechanic sets a time (for example, 3:00 AM) when the car shall perform a resync operation.

The following procedure describes how to set the jack resync time.

1. Navigate to MAIN MENU | SETUP | HYDRO (See Figure 63).
2. From the HYDRO SETUP menu, scroll and select Jack Resync.

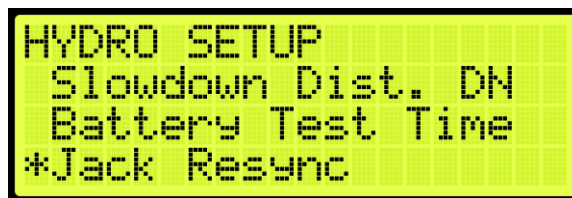
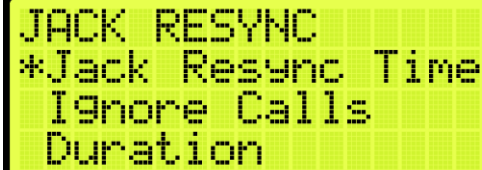

Figure 372: HYDRO SETUP Menu – Jack Resync

3. From the JACK RESYNC Menu, select Jack Resync Time.



```
JACK RESYNC
*Jack Resync Time
Ignore Calls
Duration
```

Figure 373: JACK RESYNC Menu – Jack Resync Time

4. From the JACK RESYNC TIME menu, enter the time jack resync is performed.



```
JACK RESYNC TIME

00:00
*
```

Figure 374: JACK RESYNC TIME Menu

5. Scroll right and press Save.

19.9 Disable NTS Alarm

By default, the NTS alarm is disabled. The NTS alarm is enabled during the NTS acceptance test.

The following procedure describes how to disable the NTS alarm.

1. Navigate to MAIN MENU | SETUP | HYDRO (See Figure 63).
2. From the HYDRO SETUP menu, scroll and select Disable NTS Alarm.

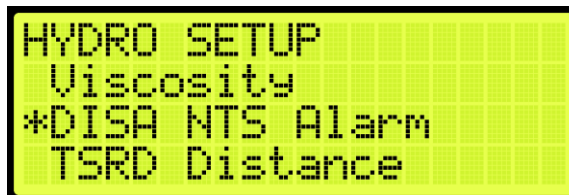

```
HYDRO SETUP
Viscosity
*DISA NTS Alarm
TSRD Distance
```

Figure 375: HYDRO SETUP Menu – Disable NTS Alarm

3. From the DISABLE NTS ALARM menu, select ON to disable the alarm.



```
DISA NTS ALARM

ON
*
```

Figure 376: DISABLE NTS ALARM Menu

4. Scroll right and press Save.

19.10 Viscosity

Viscosity comes into play when the oil is too cold. To enable this operation, set the Run Time, the Rest Time, the number of Cycles Allowed, and whether to Allow Calls or not.

19.10.1 Run Time

To set the run time for viscosity operation, follow this procedure:

1. Navigate to MAIN MENU | SETUP | HYDRO (See Figure 63).
2. From the HYDRO SETUP menu, scroll and select Viscosity.

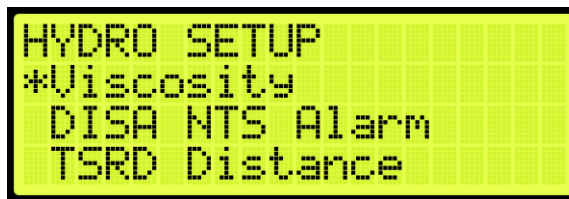

Figure 377:HYDRO SETUP Menu – Viscosity

3. From the VISCOSITY menu, select Run Time 1min.

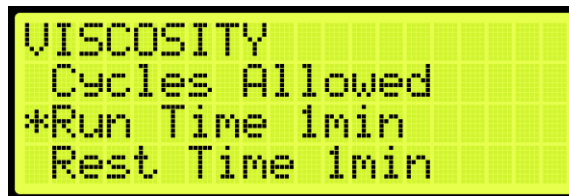

Figure 378: VISCOSITY Menu – Run Time 1min

4. From the RUN TIME 1MIN menu, set the desired run time in minutes.

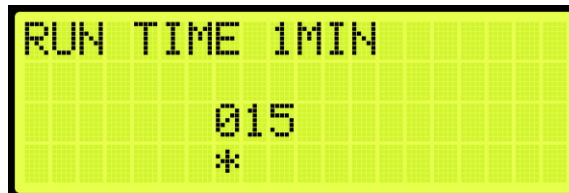

Figure 379: RUN TIME 1MIN Menu

5. Scroll right and press Save.

19.10.2 Rest Time

To set the rest time for viscosity operation, follow this procedure:

1. Navigate to MAIN MENU | SETUP | HYDRO (See Figure 63).

- From the HYDRO SETUP menu, scroll and select Viscosity.



Figure 380:HYDRO SETUP Menu – Viscosity

- From the VISCOSITY menu, select Rest Time 1min.



Figure 381: VISCOSITY Menu – Rest Time 1min

- From the REST TIME 1MIN menu, set the desired rest time in minutes.

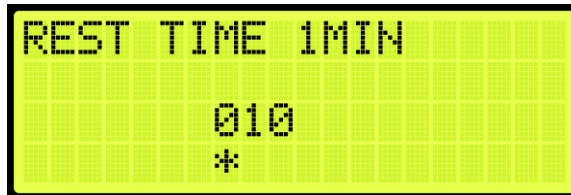

Figure 382: REST TIME 1MIN Menu

- Scroll right and press Save.

19.10.3 Cycles Allowed

To set the number of cycles allowed during viscosity operation, follow this procedure:

- Navigate to MAIN MENU | SETUP | HYDRO (See Figure 63).
- From the HYDRO SETUP menu, scroll and select Viscosity.

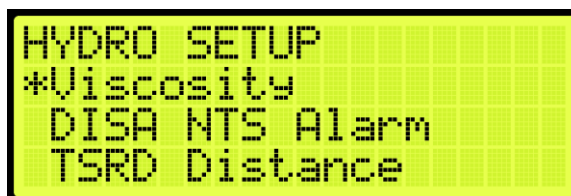

Figure 383:HYDRO SETUP Menu – Viscosity

- From the VISCOSITY menu, select Cycles Allowed.



Figure 384: VISCOSITY Menu – Cycles Allowed

4. From the CYCLES ALLOWED menu, set the desired number of cycles.



Figure 385: CYCLES ALLOWED Menu

5. Scroll right and press Save.

19.10.4 Allow Calls

To allow calls during viscosity operation, follow this procedure:

1. Navigate to MAIN MENU | SETUP | HYDRO (See Figure 63).
2. From the HYDRO SETUP menu, scroll and select Viscosity.

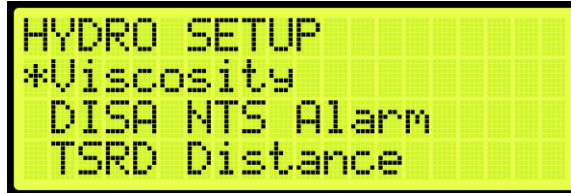

Figure 386: HYDRO SETUP Menu – Viscosity

3. From the VISCOSITY menu, select Allow Calls.



Figure 387: VISCOSITY Menu – Allow Calls

4. From the ALLOW CALLS menu, select ON to allow calls during viscosity operation.



Figure 388: ALLOW CALLS Menu

5. Scroll right and press Save.

19.11 Low Oil

The Low Oil feature renders the elevator on normal operation inoperative if, for any reason, the liquid level in the tank falls below the permissible minimum.

This feature is manually activated via an input - see Section 21.3 Types of Inputs.

This feature is automatically activated when the predefined Max Run Time is exceeded. In this case, the MRA will indicate a Low Oil MLT Fault- see Section 42.4 List of Faults.

Actuation of the means shall automatically bring the car down to the lowest landing when the doors are closed.

20 Data Acquisition Device Unit

Each Smartrise Controller comes wired to a DAD unit that comes equipped with a Graphical User Interface Application (GUI). The following section explains how to connect wirelessly to the DAD unit and access its application using a laptop or a tablet. See *Hydro:Evolved GUI Manual* for more information.

20.1 DAD Status

The DAD status displays the status and communication of the DAD unit.

The following procedure describes how to view the DAD status.

1. Navigate to MAIN MENU | STATUS | DAD STATUS (See Figure 50).
2. From the DAD STATUS menu, view the status of the DAD unit.



Figure 389: DAD STATUS Menu

The DAD STATUS menu displays the following:

- **DAD STATUS:** shows if the DAD unit is ONLINE or OFFLINE.
- **ERROR:** displays the current fault the DAD unit is experiencing if a red LED light is blinking on the DAD unit.
- **Version:** shows the current software version of the DAD unit.
- **RX Count:** displays the communication packets the controller is receiving from the DAD unit.

21 Assigning Inputs and Outputs

Like previous Smartrise controllers, the Hydro:Evolved retains the ability to change, add, remove, or move inputs and outputs if they are not fixed (inputs/outputs that cannot be changed due to safety issues). Any UNUSED input or output can be assigned a feature if the installer needs additional features or needs to move an input or output.

Inputs can only be assigned to the 500's and outputs to the 600's. As such, if an output is being searched for and attempted to assign it to a 500 section, the feature will not be found.

21.1 Adding an Input or Output

The following procedure describes how to add an input or output.

1. Navigate to MAIN MENU | SETUP | SETUP I/O (See Figure 56).
2. From the SETUP I/O menu, select Setup Inputs for the Input menu or Setup Outputs for the Output Menu (See Figure 179).
3. From the SELECT BOARD menu, select which board the input or output is assigned to (See Figure 180).
4. Press the up button until there is an unused input/output available.

NOTE: for this example, we are showing the input.



Figure 390: Unused Input/Output

The Unused Input/Output displays the following:

- The second and third lines display unused.
 - The number on top indicates which input/output is currently being viewed. For example, Figure 390 shows an example of an unused input.
 - 503 is the input that is currently being viewed.
 - 508 states how many inputs there are for that specific board.
5. Scroll right.
 6. Scroll and select the desired category of the input or output. See Table 32 and Table 42 for types of inputs and outputs.

NOTE: the category is the second line.

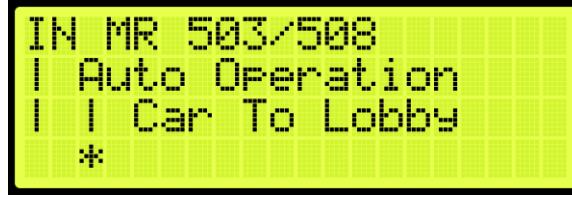

Figure 391: Category and Input

7. Scroll right.
8. Scroll and select the desired input or output. Figure 391 shows the Auto Operation category to assign Car to Lobby to an unused input.
9. Scroll right and press Save.

21.2 Removing an Input or Output

The following procedure describes how to remove an input or output.

1. Navigate to MAIN MENU | SETUP | SETUP I/O (See Figure 56).
2. From the SETUP I/O menu, select Setup Inputs for the Input menu or Setup Outputs for the Output Menu (See Figure 179).
NOTE: the input and output steps are the same.
3. From the SELECT BOARD menu, select which board the input or output is being removed from (See Figure 180).
4. Scroll and select the input or output to be removed (See Figure 391).
5. Scroll right.
6. Scroll and select the current input or output to unused.
7. Scroll right.
8. Scroll and select the desired category of the input/output to unused.
9. Scroll right and press Save.

21.3 Types of Inputs

The tables below list the definition for the types of inputs per category.

Table 32: Description of Auto Operation Inputs

Input	Description
Active Shooter	Places all cars in a group into Active Shooter Mode (must be programmed to a shared group input on each car).

Input	Description
Attd Byp	When active, attendant operation causes the car to skip past all hall calls between its current position and current destination.
Attd Down	Sets the next direction the car will try to move when doors are closed on attendant operation.
Attd On	Puts the car on attendant operation.
Attd Up	Sets the next direction the car will try to move when doors are closed on attendant operation.
Bypass Wanderguard Next CC	Bypasses Wanderguard from inside the car for the next car call only.
Car To Lobby	Captures car and sends it to the lobby where it will hold doors open.
Clear Latched Calls	Clears all latched Calls
Custom Operation	Puts car on custom operation mode.
DISA All HC	Disables all hall calls on the car when active.
DISA Pass Chime	Disables passing chime when active.
Distress Ack	At a central control console, a distress and light buzzer is provided for each elevator and an acknowledge button common to all elevators. Pressing the distress alarm button, triggering the emergency stop switch, if a dispatched car remains at a landing for >30 seconds, or if the electrical safety circuit is open, will turn on the distress light and pulse the distress buzzer. The Distress light will remain lit until the acknowledge button is pressed.
Distress BTN	At a central control console, a distress and light buzzer is provided for each elevator and an acknowledge button common to all elevators. Pressing the distress alarm button, triggering the emergency stop switch, if a dispatched car remains at a landing for >30 seconds, or if the electrical safety circuit is open, will turn on the distress light and pulse the distress buzzer. The Distress light will remain lit until the acknowledge button is pressed.
EMS2 On	Holds car on EMS Phase 2 operation after activation of EMS Phase 1 operation.
Enable All CC	Bypasses car call security on all floors.
Enable All CC F	Enables all car call front buttons, bypassing car call security on all front car call buttons.
Enable All CC R	Enables all car call rear buttons, bypassing car call security on all rear car call buttons.
Enable All HC	Bypasses hall call security on all landings.

Input	Description
ENA Down Peak	Causes the car to park at the top floor when idle.
ENA Lobby Peak	Causes the car to park at the lobby floor when idle.
ENA Up Peak	Causes the car to park at the bottom floor when idle.
Enable Swing	Puts car on swing operation, removing the car from regular group calls and allowing it to take swing hall calls.
Indep Srv	Puts car on independent service operation.
Light Load	Analog load weigher signal indicating weight below configured threshold. Used for anti-nuisance features.
Marshal Mode	Puts the car on marshal mode operation.
Parking Off	Disables parking.
Sabbath	Puts car on Sabbath operation where car will automatically move to configured floors and cycle doors, without user intervention.
Wander Guard	Puts the car on wander guard operation.
Enable HC Timed Security	Activation will enable the HC timed security
Terminal Express	Activation of terminal express mode of operation
Single Automation Push Button	Activation of Single Automatic Push Button (SAPB) feature
Buffered HC	Activation of Buffered HC dispatch logic
MA EMS1	Activation of EMS1 service via key switch
Override Group Hall Mask	Overrides the Hall call group mask by a car specific hall mask
Ignore All CC Front	Ignoring of all car calls front
Bypass Wanderguard Next CC	Bypasses Wanderguard from inside the car for the next car call only

Table 33: Description of Car Call (Front and Rear) Inputs

Input	Description
Buttons 1-96	Front car call buttons.
Buttons 1-96	Rear car call buttons.

Table 34: Description of Car Call Enable (Front and Rear) Inputs

Input	Description
Keys 1-96	Input that is required to be activated whenever there is a front car call to a secured floor.
Keys 1-96	Input that is required to be activated whenever there is a rear car call to a secured floor.

Table 35: Description of Controller Inputs

Input	Description
Auto Rescue	When active, and the car is put on battery rescue operation, car will recall to the landing requiring the least energy to reach. When inactive, car will fault until the manual rescue procedure is executed.
Battery Fault	When active, car will assert a battery fault (F656).
Battery Power	Puts the car on battery rescue operation.
Brake1 BPS	AC primary brake BPS input. Signals that the brake has fully picked. Only checked if programmed.
Brake2 BPS	AC secondary brake BPS input. Signals that the brake has fully picked. Only checked if programmed.
Delta	(Hydro Only) Feedback input from the Delta relay which picks the Run Contactor in a Wye Delta starter configuration.
DNH Valve Mon	(Hydro Only) Monitoring of safety relay for cutting the down high valve 's neutral side. If the input is high, the valve's neutral side is disconnected. Only checked if programmed.
DSD Run Engaged	This is a redundant message from the DSD drive that it has control of the sheave and the brakes can be lifted. Only checked if programmed.
Fan And Light	When active, causes the output LIGHT FAN to also activate.
Fault	Generic fault that will stop the car with F713.
Insp Valve Mon	(Hydro Only) Monitoring of safety relay for cutting the inspection valve 's neutral side. If the input is high, the valve's neutral side is disconnected. Only checked if programmed.
Manual Pick	Indication to the controller that a manual rescue is occurring.
OOS	Puts the car in out of service operation.
Phase Flt	Line monitoring hardware has detected voltage lines are out of phase or missing. Only checked if programmed.
Rec Trv Dir	When the car is on automatic battery rescue operation. For Magnetek drives, this indicates to the car that the easiest direction to move is down. When inactive, this indicates that the easiest direction is up.
Rec Trv On	When the car is on automatic battery rescue operation. For Magnetek drives, this indicates to the car that it has determined the easiest direction for the car to move, indicated by REC TRV DIR.

Input	Description
Regen Flt	When active, causes the C4 car to assert a regen fault (F254).
SS Flt	(Hydro Only) Primary soft starter signaling a generic fault. Only checked if programmed.
SS2 Flt	(Hydro Only) Secondary soft starter signaling a generic fault. Only checked if programmed.
Start OVLD	(Hydro Only) Feedback input from the contactor starter overload relay. Used for jobs with a contactor starter.
UPH Valve Mon	(Hydro Only) Monitoring of safety relay for cutting the up high valve 's neutral side. If the input is high, the valve's neutral side is disconnected. Only checked if programmed.
Valve Flt	(Hydro Only) Valve controller generic fault.
Inching Enable	Enables Inching operation, which is a special mode of operation permitting the car to move within DZ while doors are open.
Inching Up	Moves car up when inching operation is enabled. Activated by constant pressure.
Inching Down	Moves car down when inching operation is enabled. Activated by constant pressure.
Inching Safe	Safety input enables up/down movement on inching operation
SS3 Fault	(Hydro Only) Third soft starter signaling a generic fault. Only checked if programmed.

Table 36: Description of Front Doors Inputs

Input	Description
BCL	Indicates that the manual hall doors for the bottom floor front opening are closed.
DCB	Door close button, requests that the front door closes.
DCL	Car door, door close limit input indicating that the front door is closed.
DOB	Door open button, requests that the front door opens.
DOL	Car door, door open limit input indicating the front door is open.
DPM	Car door position monitor input indicating front door is closed. Checked only if programmed.
HOLD	Door hold button, requests that the front door opens and remains open for a longer than usual dwell period.
Marshl DCB	For Marshal Mode Only DCB Front for remote console
Marshl DOB	For Marshal Mode Only DOB Front for remote console

Input	Description
MCL	Indicates that the manual hall doors for all the middle floors front openings are closed.
PHE	Car door photoeye input indicating that the front door light curtain is obstructed and doors are not permitted to close.
PHE ALT	Alternate photoeye input logically AND'ed with the primary photoeye. Photoeye is active if either signal is low. Used with Peelle light curtain.
Safety Edge	Indicates that the safety edge is obstructed and doors are not permitted to close. For freight doors only.
TCL	Indicates that the manual hall doors for the top floor front opening are closed.
Front Doors Gateswitch	Car door gateswitch contact indicating front door is closed.
Front Doors Zone	Car door door zone input indicating the front door can open.

Table 37: Description of Rear Doors Inputs

Input	Description
BCL	Indicates that the manual hall doors for the bottom floor rear opening are closed.
DCB	Door close button, requests that the rear door closes.
DCL	Car door, door close limit input indicating that the rear door is closed.
DOB	Door open button, requests that the rear door opens.
DOL	Car door, door open limit input indicating the rear door is open.
DPM	Car door position monitor input indicating rear door is closed. Checked only if programmed.
HOLD	Door hold button, requests that the rear door opens and remains open for a longer than usual dwell period.
Marshl DCB	For Marshal Mode Only DCB Rear for remote console
Marshl DOB	For Marshal Mode Only DOB Rear for remote console
MCL	Indicates that the manual hall doors for all the middle floors rear openings are closed.
PHE	Car door photoeye input indicating that the rear door light curtain is obstructed and doors are not permitted to close.
PHE ALT	Alternate photoeye input logically AND'ed with the primary photoeye. Photoeye is active if either signal is low. Used with Peelle light curtain.
Safety Edge	Indicates that the safety edge is obstructed and doors are not permitted to close. For freight doors only.

Input	Description
TCL	Indicates that the manual hall doors for the top floor rear opening are closed.
Rear Doors Gateswitch	Car door gateswitch contact indicating rear door is closed.
Rear Doors Door Zone	Car door door zone input indicating the rear door can open.

Table 38: Description of Emergency Power Inputs

Input	Description
AutoSelect	After all cars have completed their recall, a preconfigured number of cars are released to go back to automatic operation. These cars are auto selected.
EP On	Car is moving from generator power back to main line power, cars should stop at their nearest reachable landings and hold doors open.
Pretransfer	Car is moving from generator Description back to main line power. Cars should stop at their nearest reachable landings and hold doors open.
Select1	After all cars have completed their recall, a preconfigured number of cars are released to go back in to automatic operation. These cars are manually selected via the select inputs if Auto Select is inactive.
Select2	After all cars have completed their recall, a preconfigured number of cars are released to go back in to automatic operation. These cars are manually selected via the select inputs if Auto Select is inactive.
Select3	After all cars have completed their recall, a preconfigured number of cars are released to go back in to automatic operation. These cars are manually selected via the select inputs if Auto Select is inactive.
Select4	After all cars have completed their recall, a preconfigured number of cars are released to go back in to automatic operation. These cars are manually selected via the select inputs if Auto Select is inactive.
Select5	After all cars have completed their recall, a preconfigured number of cars are released to go back in to automatic operation. These cars are manually selected via the select inputs if Auto Select is inactive.
Select6	After all cars have completed their recall, a preconfigured number of cars are released to go back in to automatic operation. These cars are manually selected via the select inputs if Auto Select is inactive.

Input	Description
Select7	After all cars have completed their recall, a preconfigured number of cars are released to go back in to automatic operation. These cars are manually selected via the select inputs if Auto Select is inactive.
Select8	After all cars have completed their recall, a preconfigured number of cars are released to go back in to automatic operation. These cars are manually selected via the select inputs if Auto Select is inactive.
UpToSpeed	Car is on generator power. Generator has spun up and cars can begin recalling one at a time to the lobby where they will hold doors open.

Table 39: Description of Fire/Earthquake Inputs

Input	Description
EQ Hoistway Scan	Initiates the hoistway scan for earthquake at low speed.
Fire2 Cncl	In car Fire Phase 2 cancel keyswitch is ON. The car will cancel its current destination and not take calls until the input is deactivated.
Fire2 Hold	In car Fire Phase 2 keyswitch is in the HOLD position.
Fire2 Off	In car Fire Phase 2 keyswitch is in the OFF position.
Fire2 On	In car Fire Phase 2 keyswitch is in the ON position.
Fire Recall Off	Car is being commanded to go on fire phase 1 recall via the main keyswitch. Fire Recall Rst activation takes priority of this status.
Fire Recall Rst	Car is commanded to exit Fire Phase 1 recall via the main keyswitch.
Mashal Fire Ovl	When active, in the "Secure" position, all "Fireman's Recall" devices for the elevator shall be deactivated.
Remote Fire Key	Car is being commanded to go on Fire Phase 1 recall via a remote keyswitch. Only checked when programmed.
Seismic	Seismic activity detected, puts car on Seismic Mode of operation.
Smoke Alt	Alternate recall floor smoke detector indicating fire is detected.
Smoke HA	Hoistway smoke sensor indicating fire is detected.
Smoke HA 2	Secondary hoistway smoke sensor indicating fire is detected. Used for a jobsite where the group is split between two machine rooms.
Smoke Main	Main recall floor smoke detector indicating fire is detected.
Smoke MR	Machine room smoke detector indicating fire is detected.

Input	Description
Smoke MR 2	Secondary machine room smoke detector indicating fire is detected. Used for a jobsite where the group is split between two machine rooms.
Smoke Pit	Pit smoke sensor indicating fire is detected. Not checked if not programmed.
Shunt Trip Intent	When active, the shunt trip recall mode of operation is activated

Table 40: Description of Inspection Inputs

Input	Description
IL Down	Moves the car down when on in car inspection mode.
IL Up	Moves the car up when on landing inspection mode.
IP Down	Moves the car down when on pit inspection mode.
IP Up	Moves the car up when on pit inspection mode.
Pit Inspection Operation	When MR SRU DIP B4 is ON, parameter Enable_Pit_Inspection (01-37) is ON, and 501 is activated, this input puts the car on Pit inspection operation. NOTE: 501 is normally closed; to activate the input, disconnect 24 V.
Landing Inspection Operation	When MR SRU DIP B3 is ON, parameter Enable_Landing_Inspection (01-38) is ON, and 502 is activated, this input puts the car on Landing inspection operation. NOTE: 502 is normally closed; to activate the input, disconnect 24 V.
CT UP	Moves the car up when activated with the INSP__CT_EN input also active and on car top inspection mode.
CT DN	Moves the car down when activated with the INSP__CT_EN input also active and on car top inspection mode.
IC UP	Moves the car up when on in car inspection mode.
IC DN	Moves the car down when on in car inspection mode.
CT Enable	Enables the INSP__CT_UP and INSP__CT_DN inputs.

Table 41: Description of Safety Inputs

Input	Description
Flood	Puts car on flood operation.
Full Load	Analog load weigher signal indicating the weight is above the configured threshold and the car cannot take additional passengers, car will remove itself from group (stop taking hall calls).

Input	Description
Low Oil	(Hydro Only) N/C input signals low oil.
Low PRESS	(Hydro Only) N/C input signals low pressure.
Motor OVHT	N/C input signals motor overheat.
Over Load	Analog load weigher signal indicating the weight is above the configured threshold and the car cannot move. Car will remain stopped with an overload fault F246.
Phone Failure	Indicates if in car emergency phone has failed. A17-2013, 2.27.1.1.6
Phone Reset	Resets the emergency phone failure buzzer. A17-2013, 2.27.1.1.6
TLoss Reset	Alternate method of resetting a latched traction loss fault via moveable input.
Viscosity	(Hydro Only) N/C input signals cold oil.
Flood Reset	Resets flood operation when programmed.
Glass Window Switch	Glass window switch input.
Rupture Switch	Rupture switch input.
Pressure Switch	Pressure switch input.
Collapsible Fully Stowed	Collapsible fully stowed input for CT inspection
Collapsible Fully Extended	Collapsible fully extended input for CT inspection
Tfl2	Top Final Limit 2 input
Enable Tfl2	Bypass TFL when on CT-inspection mode
Clear Warning Light	When active, it clears warning light
Oil Overheat	(Hydro Only) N/C input signals High temp oil.
BYPASS LWD	Bypass LWD signals

21.4 Types of Outputs

The tables below list the definitions for the types of outputs per category.

Table 42: Description of Auto Operation Outputs

Output	Description
Accelerating	Activates when the car is in the acceleration stage of its run.
Active Shooter	Output activated whenever the "Active shooter" mode input is on.
At Landing Lamp	Output indicates car is at landing and idle in automatic normal mode.
Arrival DN 1	Discrete arrival lantern output, set 1. See 08-197 and 01-175.
Arrival DN 2	Discrete arrival lantern output, set 2. See 08-198 and 01-176.

Output	Description
Arrival DN 3	Discrete arrival lantern output, set 1. See 08-199 and 01-177.
Arrival DN 4	Discrete arrival lantern output, set 2. See 08-200 and 01-178.
Arrival DN 5	Discrete arrival lantern output, set 2. See 08-201 and 01-179.
Arrival UP 1	Discrete arrival lantern output, set 1. See 08-197 and 01-175.
Arrival UP 2	Discrete arrival lantern output, set 2. See 08-198 and 01-176.
Arrival UP 3	Discrete arrival lantern output, set 1. See 08-199 and 01-177.
Arrival UP 4	Discrete arrival lantern output, set 2. See 08-200 and 01-178.
Arrival UP 5	Discrete arrival lantern output, set 2. See 08-201 and 01-179.
Buzzer	Triggers an audible in car buzzer when the car is overloaded, on fire, nudging, on EMS Phase 1, or when on Attendant and there is a demand.
Car To Lobby	This output activates if the car has finished its recall triggered by the car to lobby input.
CC Acknowledge	Activates when a car call is placed. This is used in Canada for blind people.
Chime	Activates when the car is in an automatic mode of operation and the passing chime disable Output is inactive. The chime is triggered for 500ms every time the car's PI changes.
Decelerating	Activates when the car is in the deceleration stage of its run.
Distress Buzzer	At a central control console, a distress and light buzzer will be provided for each elevator and an acknowledge button common to all elevators. Pressing the distress alarm button, triggering the emergency stop switch, if a dispatched car remains at a landing for >30 seconds, or if the electrical safety circuit is open will turn on the distress light, and pulse the distress buzzer. The Distress light will remain lit until the acknowledge button is pressed.

Output	Description
Distress Lamp	At a central control console, a distress and light buzzer will be provided for each elevator and an acknowledge button common to all elevators. Pressing the distress alarm button, triggering the emergency stop switch, if a dispatched car remains at a landing for >30 seconds, or if the electrical safety circuit is open will turn on the distress light, and pulse the distress buzzer. The Distress light will remain lit until the acknowledge button is pressed.
In Service	Activates if hall calls are not disabled and the car is not faulted.
In Use	Activates when the car is not in normal operation, is in motion, or has its doors open.
Group Redundancy	Switches power to a redundant set of Riser boards.
Lamp At Recall	Activates when the car has completed EMS, Fire, or emergency power recall.
Lamp Attnd Above	Activates when the car is in attendant operation and there is a hall call at a floor above.
Lamp Attnd Below	Activates when the car is in attendant operation and there is a hall call at a floor below.
Lamp EMS	Activates when the car is in EMS Phase 1 or Phase 2.
Lamp Indp Srv	Activates when the car is in independent service operation.
Lamp Parking	Triggers when the car is in normal operation and is parked.
Lamp Sabbath	Activates when the car is in Sabbath operation.
Overloaded	Activates when the car is in an automatic mode of operation and the load weigher has flagged an overloaded state.
Travel Dn	Triggers when the car is moving down.
Travel Up	Triggers when the car is moving up.
VIP Mode	This output is activated when car is on VIP mode of operation
Near Capacity Lamp	Output activated when full load input is activated

Table 43: Description of Car Call (Front and Rear) Outputs

Output	Description
Lamp 1-96	Front car call lamps.
Lamp 1-96	Rear car call lamps.

Table 44: Description of Controller Outputs

Output	Description
Auto Rescue	Lamp output when auto rescue is active.
Battery Pwr	Output signaling car is on battery power.
BPS Status	Activates when the primary brake pick switch signals the brake is open. Used for TKE UBS DD project.
BPS2 Status	Activates when the secondary brake pick switch signals the brake is open. Used for TKE UBS DD project.
Brake1 Pick	AC primary brake pick output.
Brake2 Pick	AC secondary brake pick output.
CEDES Fan	CEDES Maintenance Fan output. Blows air at Cedes tape when in motion to clear accumulated dust.
Delta	(Hydro Only) Output to the Delta relay which picks the Run Contactor in a Wye Delta starter configuration.
Drive HW Enable	Triggers prerun energizing of the DSD DC drive.
Hoistway Lamp	Output indicates car in hoistway/access/inspection mode or fire phase 2 mode.
Light Fan	Turns on car light and fan hardware.
MR Fan	Fan output that will remain active for an adjustable period of time after each run.
Rec Trv Enable	Enables recommended travel direction of Magnetek drives.
Regen Enable	Activates the regen.
Regen Reset	Triggers a reset of an active regen fault.
Safety Rescue	Triggers manual rescue in event of power loss.
SS Reset	(Hydro Only) Output to the cycle power to a faulted soft starter.
Start Motor	(Hydro Only) Output to start pump motor.
Start Motor 2	(Hydro Only) Output to start pump motor (secondary soft starter).
Valve High Down	(Hydro Only) Output to trigger the high speed valve in the down direction.
Valve High Up	(Hydro Only) Output to trigger the high speed valve in the up direction.
Valve Insp	(Hydro Only) Output to signal to blaine valve controller that the car is attempting an inspection run.
Valve Level Down	(Hydro Only) Output to trigger the leveling speed valve in the down direction. For V2 this is the DNL valve.
Valve Level Up	(Hydro Only) Output to trigger the leveling speed valve in the up direction. For V2 this is the UPL valve.
Valve Low Down	(Hydro Only) Output to trigger the low speed valve in the down direction. This is not the DNL valve for V2, that is marked CTRL__VALVE_LEVEL_DOWN valve for C4.

Output	Description
Valve Low Up	(Hydro Only) Output to trigger the low speed valve in the up direction. This is not the UPL valve for V2, that is marked CTRL__VALVE_LEVEL_UP valve for C4.
Valve Mid Down	(Hydro Only) Output to trigger the medium speed valve in the down direction.
Valve Mid Up	(Hydro Only) Output to trigger the medium speed valve in the up direction.

Table 45: Description of Front Doors Outputs

Output	Description
Arrival Down	Arrival down turns on when the car arrives at a floor then opens its doors and intends to continue moving down.
Arrival Up	Arrival up turns on when the car arrives at a floor then opens its doors and intends to continue moving up.
CAM	Retiring CAM. For swing hall doors and some freight doors, this output controls the hall locks. This output turns on when the car is in motion.
DC	Door close.
DCL	Door closed limit status. This output turns ON when the door closed limit switch signals the door is closed.
DCM	Used by Peelle door operator. Triggers door operator fast open/close where landing and car door movement will occur simultaneously.
DCP	Door close protection.
DO	Door open.
DOL	Door open limit status. This output turns ON when the door open limit switch signals the door is open.
Gate Release	Gate release.
Hold Lamp	Door hold.
NDG	Door nudge. After a specified timeout, if the door has not closed, the doors will move to a nudging state where the PHE is ignored and the nudging output will turn on.
Restrictor	Door restrictor.
Safety Edge	Safety edge broken status. This output turns ON when the safety edge or photoeye is broken.
Test	Used by Peelle light curtain to test for photoeye failure prior to each close attempt.

Output	Description
Warning Buzzer	Used by Peelle door operator. Activates 5 seconds before starting door close and remains on until doors fully closed.
Start Motor	(hydro only) states that motor running and moving upward

Table 46: Description of Rear Doors Outputs

Output	Description
Arrival Down	Arrival down turns on when the car arrives at a floor then opens its doors and intends to continue moving down.
Arrival Up	Arrival up turns on when the car arrives at a floor then opens its doors and intends to continue moving up.
CAM	Retiring CAM. For swing hall doors and some freight doors, this output controls the hall locks. This output turns on when the car is in motion.
DC	Door close.
DCL	Door closed limit status. This output turns ON when the door closed limit switch signals the door is closed.
DCM	Used by Peelle door operator. Triggers door operator fast open/close where landing and car door movement will occur simultaneously.
DCP	Door close protection.
DO	Door open.
DOL	Door open limit status. This output turns ON when the door open limit switch signals the door is open.
Gate Release	Gate release.
Hold Lamp	Door hold.
NDG	Door nudge. After a specified timeout, if the door has not closed, the doors will move to a nudging state where the PHE is ignored and the nudging output will turn on.
Restrictor	Door restrictor.
Safety Edge	Safety edge broken status. This output turns ON when the safety edge or photoeye is broken.
Test	Used by Peelle light curtain to test for photoeye failure prior to each close attempt.
Warning Buzzer	Used by Peelle door operator. Activates 5 seconds before starting door close and remains on until doors fully closed.

Table 47: Description of Emergency Power Outputs

Output	Description
Lamp On EP	Car is on emergency power operation.

Output	Description
Select 1	Car is on emergency power operation and is recalling or has been released back into automatic operation.
Select 2	Car is on emergency power operation and is recalling or has been released back into automatic operation.
Select 3	Car is on emergency power operation and is recalling or has been released back into automatic operation.
Select 4	Car is on emergency power operation and is recalling or has been released back into automatic operation.
Select 5	Car is on emergency power operation and is recalling or has been released back into automatic operation.
Select 6	Car is on emergency power operation and is recalling or has been released back into automatic operation.
Select 7	Car is on emergency power operation and is recalling or has been released back into automatic operation.
Select 8	Car is on emergency power operation and is recalling or has been released back into automatic operation.

Table 48: Description of Fire/Earthquake Outputs

Output	Description
EQ Slow Lamp	Activates when the car is in EQ Hoistway Scan operation.
Fire I Active	Used by Peelle door operator. Active if Fire Phase 1 is active and recall has not completed.
Fire I Hold	Activates when the car has arrived at the fire recall floor and is on Fire Phase 1.
Fire II Active	Used by Peelle door operator. Active if Fire Phase 2 is active.
Fire II Hold	Used by Peelle door operator. Active if on Fire Phase 2 hold operation.
Fire Shunt	Activates when the car is on fire service and has completed its recall.
Lamp EQ	Turns on when the car is on seismic or counterweight derail modes of operation.
Lamp Fire	Activates when the car is in fire service operation. Depending on the configuration, it will either flash every 500 ms or stay ON the whole time.
Lamp Fire Lobby	Activates when the car is in fire service operation. Depending on the configuration it will either flash every 500 ms or stay ON the whole time.
Lamp Seismic Status	Activates when the car is on Seismic.

Table 49: Description of Inspection Output

Output	Description
Lamp Insp	Signals when the car is on inspection.

Table 50: Description of Safety Outputs

Output	Description
Lamp Flood	Car's flood sensor has detected a flood.
Phone Fail Lamp	Lamp indicating emergency phone has failed. A17-2013, 2.27.1.1.6
Phone Fail Buzzer	Buzzer indicating emergency phone has failed. A17-2013, 2.27.1.1.6
Ebrake Status	Output that reflects Ebrake status output
Warning Light	Output activated when an unauthorized car call is detected

21.5 Invert Inputs

After a type of input has been assigned, the input may need to have the system to monitor the state of the input either to active or inactive. The invert inputs allow for changing the monitoring of the assigned input.

The following procedure describes how to change the state of the input.

1. Navigate to MAIN MENU | SETUP | SETUP I/O (See Figure 56).
2. From the SETUP I/O menu, scroll and select Invert Inputs.

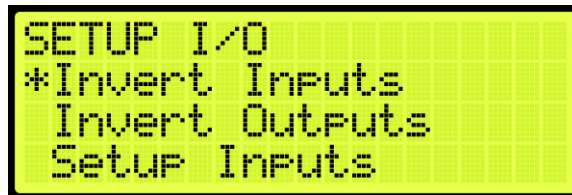

Figure 392: SETUP I/O Menu – Invert Inputs

3. From the SELECT BOARD menu, scroll and select the board that has an assigned input changing states (See Figure 180).

NOTE: for this example, the MR board is shown.

4. From the Invert Inputs menu, scroll and select the assigned input and if the input is active (On) or inactive (Off).



Figure 393: Invert Inputs Menu

5. Scroll right and press Save.

21.6 Invert Outputs

Just as invert inputs monitors the state of an assigned input (active low instead of active high), the invert outputs does the same but for an assigned output. After a type of output has been assigned, the output may need to have the system invert the level of the active/inactive output logic. The invert output allows for changing the logic level of the assigned output.

The following procedure describes how to change the state of the output.

1. Navigate to MAIN MENU | SETUP | SETUP I/O (See Figure 56).
2. From the SETUP I/O menu, scroll and select Invert Outputs.

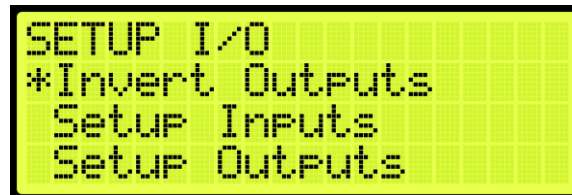

Figure 394: SETUP I/O Menu – Invert Outputs

3. From the SELECT BOARD menu, scroll and select the board that has an assigned output changing states (See Figure 180).

NOTE: for this example, the MR board is shown.

4. From the Invert Outputs menu, scroll and select the assigned input and if the input is Active (On) or Inactive (Off).

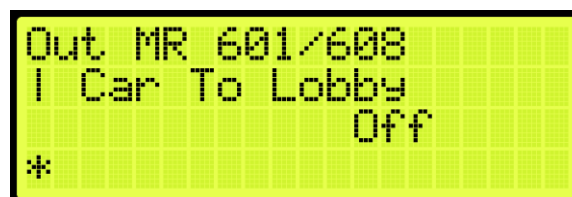

Figure 395: Invert Outputs Menu

22 VIP

A car configured for VIP will be selected when this mode of operation is activated by a specially configured Hall board. The car will service all existing car calls and ignore all hall calls until all existing car calls have been serviced. The car now responds to a VIP hall call and opens the doors. There is a minimum of five seconds allowed for a VIP entry for a new car call. Once all car calls have been serviced, the car exits VIP mode.

23 Active Shooter

Active Shooter is a type of auto operation that prevents a shooter from having easy access to an additional way to escape. Active shooter is enabled by a key switch.

When Active Shooter is enabled, the car automatically closes the doors, the PI Display alternate between floor label and crisis (CR), and the cars do not respond to any hall or car calls. All cars within the group are recalled to an alternate recall floor, the doors open, and remain open. When Active Shooter is disabled, all cars go back to normal operation.

To set the controller to active shooter, see Section 21.1 Adding an Input or Output.

24 Marshal Mode

Marshal Mode is a type of auto operation that takes the car out of the group and is enabled via a key switch input. When the key switch is enabled, the car clears all latched car and hall calls, then stops at the next available landing. Both front and rear doors remain closed regardless of people being inside the car.

The car will not respond to any hall calls or car calls and the front and rear door open and close buttons are disabled. When the car stops at the closest available landing, it waits for commands from the marshal using the remote controller.

When the marshal makes a car call, the car will go to the landing corresponding to the car call button. When the car reaches the landing, the doors will remain closed. The marshal needs to hold the door open button until the doors are fully opened otherwise the doors go back to its closed state. Once the doors are fully open, the doors stay open. To close the doors, the marshal needs to hold the door close button until the doors are fully closed otherwise the doors go back to its opened state.

If the marshal makes multiple car calls, when the car reaches the landing, the car will wait for 10 seconds for the marshal to press and hold the door open button. If the marshal does not press the door open button until the door fully opens within the 10 second timeout, the car will be dispatched to the next latched car call landing. Once the doors are fully open, the car will keep its latched car calls and will not be dispatched to the next latched car call landing. Once the doors are fully closed, the car will be dispatched to the next latched car call landing.

To disable Marshal Mode, the key switch input needs to be off. This will cause the car to join the group and resume normal operation.

To set the controller to Marshall Mode, see Section 21.1 Adding an Input or Output.

25 Installing a New Board

If one of the boards becomes mechanically or electrically faulty, a replacement board is needed. The set parameters (timers, learned floor, etc.) can be retained after the board is replaced.

NOTE: Verify that the replacement boards received have the correct version programmed on them.

25.1 Retain Parameters for a Replaced MR Board

The following procedure describes how to transfer the parameters from the CT to the replaced MR board.

1. Turn off power to the controller.
2. Install and replace the MR board and reattach the connector terminals.
NOTE: leave group connections OFF until process is complete.
3. Turn on DIP 5B and DIP 7A (just to disable the faults and alarms from the main display).
4. Power up the Controller.
5. On power up, the MR board displays Sync In Progress (the car will be out of service).

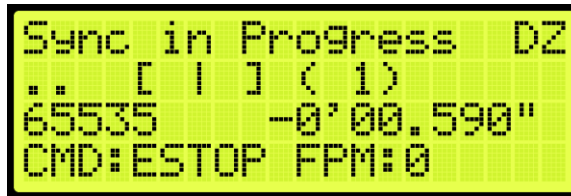

The LCD display shows the following text: Sync in Progress DZ, . . . [1] (1), 65535 -0'00.590", CMD:ESTOP FPM:0.

Figure 396: Sync In Progress

6. When complete, Sync Complete is displayed.

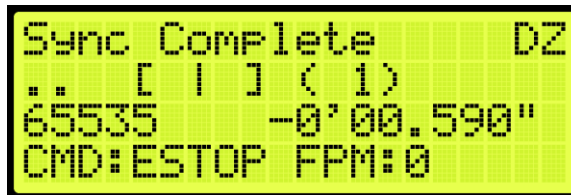

The LCD display shows the following text: Sync Complete DZ, . . . [1] (1), 65535 -0'00.590", CMD:ESTOP FPM:0.

Figure 397: Sync Complete

7. Turn off the controller.
8. Turn off DIP 5B.
9. Turn on the controller. The car resumes normal operation.

25.2 Retain Parameters for a Replaced CT or COP Board

The following procedure describes how to transfer the parameters from the MR board to the replaced CT or COP board.

1. Remove power from the controller.
2. Disconnect the connectors and remove the CT or COP board.
3. Install and replace the CT or COP board and reattach the connector terminals.

NOTE: ensure all DIP switches are correct.

4. Make sure the DIP B1 is in the correct state.

NOTE: for a CT board DIP B1 must be OFF, for COP board DIP B1 must be ON

5. Power up the controller.
6. The Sync Process automatically begins due to a checksum that consistently compares parameters between all three boards.

NOTE: there is no SYNC IN PROGRESS displayed.

7. When complete, the CT/COP board is in normal operation with all parameters retained.

26 Hoistway Access

The hoistway access safely and securely moves the car at the terminal landings to gain access to either the pit or the top of the hoistway. Normally, this is done with a key switch that enables the top or bottom access inputs on the controller. The car will only move if the doors are open.

The following procedure describes how to access the hoistway.

1. Navigate to MAIN MENU | SETUP | HOISTWAY ACCESS (See Figure 58).
2. If the hoistway is being accessed from the top of the hoistway or the pit:
 - i. If the hoistway is being accessed from the top of the hoistway, go to step 3.
 - ii. If the hoistway is being accessed from the bottom of the hoistway, go to step 14.
3. From the HOISTWAY ACCESS menu, scroll and select Allowed Distance Top.

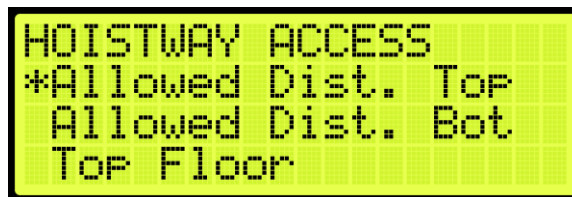

Figure 398: HOISTWAY ACCESS – Allowed Distance Top

4. From the ALLOWED DISTANCE – TOP menu, scroll and select the distance from the car to the hoistway.



Figure 399: ALLOWED DISTANCE – TOP Menu

5. Scroll right and press Save.
6. Press the left button until the HOISTWAY ACCESS menu displays.
7. From the HOISTWAY ACCESS menu, scroll and select Top Floor.



Figure 400: HOISTWAY ACCESS – Top Floor

8. From the TOP FLOOR menu, select the top floor just below the hoistway.



Figure 401: TOP FLOOR Menu

9. Scroll right and press Save.
10. Press the left button until the HOISTWAY ACCESS menu displays.
11. From the HOISTWAY ACCESS menu, scroll and select Top Opening.



Figure 402: HOISTWAY ACCESS – Top Opening

12. From the TOP OPENING menu, scroll and select the top floor the car opens just below the hoistway.

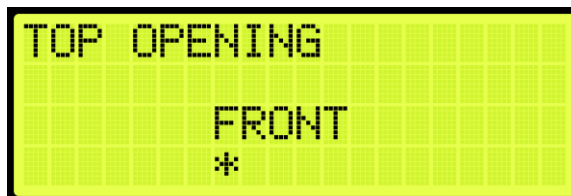

Figure 403: TOP OPENING Menu

13. Scroll right and press Save.
14. Press the left button until the HOISTWAY ACCESS menu displays.
15. From the HOISTWAY ACCESS menu, scroll and select Allowed Distance Bottom.



Figure 404: HOISTWAY ACCESS – Allowed Distance Bottom

16. From the ALLOWED DISTANCE – BOTTOM menu, scroll and select the distance from the car to the pit.



Figure 405: ALLOWED DISTANCE – BOTTOM Menu

17. Scroll right and press Save.
18. Press the left button until the HOISTWAY ACCESS menu displays.
19. From the HOISTWAY ACCESS menu, scroll and select Bottom Floor.



Figure 406: HOISTWAY ACCESS – Bottom Floor

20. From the BOTTOM FLOOR menu, select the bottom floor just above the pit.



Figure 407: BOTTOM FLOOR Menu

21. Scroll right and press Save.
22. Press the left button until the HOISTWAY ACCESS menu displays.
23. From the HOISTWAY ACCESS menu, scroll and select Bottom Opening.



Figure 408: HOISTWAY ACCESS – Bottom Opening

24. From the BOTTOM OPENING menu, scroll and select the bottom floor the car opens just above the pit.

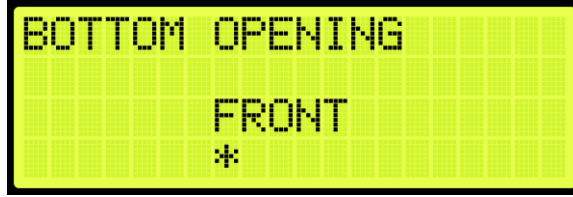

Figure 409: BOTTOM OPENING Menu

- 25. Scroll right and press Save.
- 26. Press the left button until the HOISTWAY ACCESS menu displays.
- 27. From the HOISTWAY ACCESS menu, scroll and select Hoistway Access Slide Distance.

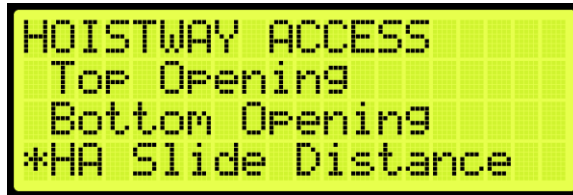

Figure 410: HOISTWAY ACCESS – Hoistway Access Slide Distance

- 28. From the HOISTWAY ACCESS SLIDE DISTANCE, enter the maximum distance the car is allowed to be within the top or bottom door zone.

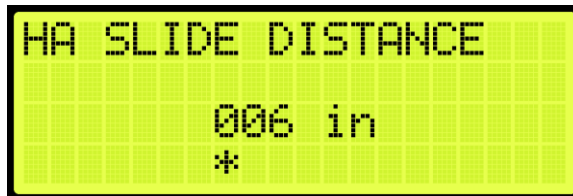

Figure 411: Hoistway Access Slide Distance

- 29. Scroll right and press Save.

27 Sequence of Operation

The information provided in this section is intended to provide a basic understanding of how Smartrise's hydro elevator controller system operates.

27.1 Car Movement

Movement of the elevator begins with the controller in the idle state. It remains in this state until a demand is entered into the system. The controller then begins the start of the run sequence. Once this is completed, the elevator car moves at a high speed until the slowdown point for the destination. The controller then switches the car to low speed until the destination is achieved. At that point, the end of the run sequence is initiated to bring the car to a full stop and return it to the idle state.

The idle state is the state in which the car remains stopped. The outputs controlling the valve board and soft starter are turned off. The controller remains in this state until a demand to move is entered into the system. The demand to move is usually a car call or a hall call entered by a passenger pressing a call button. A demand can also come from a special operation mode like fire service where a recall to the egress floor is initiated by a smoke sensor or manually by the Fire Phase 1 key switch. Regardless of what initiates the demand, the controller will determine the destination floor and switch to the start of run sequence.

The start of run sequence is the set of operations that are performed in order to transition the elevator from a stopped condition to that of being in motion. To move the car, the controller first commands the valves to open. If movement is in the upward direction, the soft starter is turned on; otherwise, it remains off.

As the car runs, the destination may change. This normally occurs when a call button is pressed for a floor located between the elevator's current position and the current destination. When this happens, the controller will determine if the new destination is achievable based on the elevator's speed, position, required slowdown distance, and location of the new demand. If the controller software determines that the new demand is achievable, the current destination is updated to the location of the new demand and the run continues. If the controller software determines that the demand is not achievable, then the car will continue to the original demand and answer the new demand when the car returns in the opposite direction. A programmable Slowdown Distance parameter tells the controller at what point it needs to drop out of high speed when approaching a destination. Since the Smartrise controller receives continuous position feedback from the landing system, there is no need for hoistway magnets or switches to perform slowdowns. All slowdowns are set electronically on the computer as a distance in feet and inches. When the elevator is less than this slowdown distance from the destination, the controller will automatically command the high speed valve to drop to move the car to low speed.

Once the car is at low speed, it begins looking for a DZ (Door Zone) magnet. Every floor in the building is marked with a single DZ magnet. When the elevator arrives at the magnet, the controller begins counting pulses from the landing system to detect how far into the magnet the car has travelled. During the controller installation, the floor level parameters were set, specifying how far from the bottom and top edges of the DZ magnet the car must travel. When these stop points are properly set, the car will stop at

level with the floor. The programmed stop point for the floor will generally be a fraction of an inch before true floor level to allow time for the end of the run sequence to carry the car to the actual level position.

The end of the run sequence consists of stopping the car by turning off the valves and soft starter only if the elevator car was moving upward.

Once fully stopped, the car returns to the idle state where it awaits the next demand.

27.2 Door Operation

Door operation begins with the doors in the idle (closed) state. The doors remain in this state until an open request is received. The controller then initiates a door open signal to the door operator. This causes the doors to open. Once the doors are fully open, they remain in the dwell (fully opened) state until a close request is received. The controller then asserts the door close output to the door operator to cause the doors to close. Once the doors are fully closed, they return to the idle state.

In the idle state, the door outputs are normally off. When the car is running, the DC (Door Close) output is normally on. This provides power to keep the doors from accidentally opening due to vibrations as the car runs. This operation can be disabled using the “DC On Any Move” parameter on the controller’s Door Setup menu. The doors will remain in the idle state until a demand to open occurs.

A demand to open occurs either when the car arrives at a floor in response to a call or when the car is stopped at a floor and the Door Open Button or a Car call or Hall call at that floor is pressed. When this happens, the controller asserts the DO (Door Open) output to the door operator to open the doors. The DO output remains on until the doors are fully opened as indicated by the DOL (Door Open Limit) contact on the door operator. Once the doors are fully open, the DO output is removed, and the doors are in the dwell (fully opened) state.

The doors remain fully open in the dwell state until a demand to close is present. In normal operation, the demand to close occurs when the doors have been fully open for the Dwell Time specified under the Door Setup menu. The dwell time can be shortened if the Door Close Button is enabled and pressed. The dwell time can be extended if a Door Hold Button is present or if the controller has been programmed to park with the doors open. The Door Hold Button will extend the dwell time for a programmable number of seconds. The Park with Doors Open parameter will keep the doors open until a call demand is entered.

Once a demand to close occurs, the DC output will be activated, and the doors will close. While the doors are in the process of closing, several events can cause them to abort the close and reopen. These events include the pressing of the Door Open Button, a call button at the floor, or the Door Hold button. Additionally, an obstruction detected by the safety edge or photoeye will cause a reopen. When the door reopens, a reduced dwell time is normally used before an attempt to close is made once again. If the doors remain obstructed for an extended period of time, an optional parameter under the Door Setup menu allows the controller to attempt to nudge the doors closed. When nudging, the DC and ND (Nudge) outputs are asserted simultaneously to cause the doors to close at reduced torque. During this operation, the safety edge and photoeye are ignored as the controller attempts to clear the obstruction.

The door operation described so far has been for automatic opening and closing. There is also a mode for continuous pressure opening and closing. This is normally used during Fire Phase II and Independent

Service. On Fire Phase II, the firefighter in the car must apply constant pressure on the Door Open Button to open the doors. If the button is released before the doors are fully open, the doors immediately reclose. Likewise, once the doors are fully open, constant pressure must be applied to the Door Close Button to close the doors. If the button is released before the doors are fully closed, they will reopen.

Independent Service utilizes the constant pressure door close operation but allows a Car Call Button to be used in place of the Door Close Button if desired. Opening of the doors on Independent Service is done automatically.

The following flow charts display the sequence of operation for car movement and door operation.

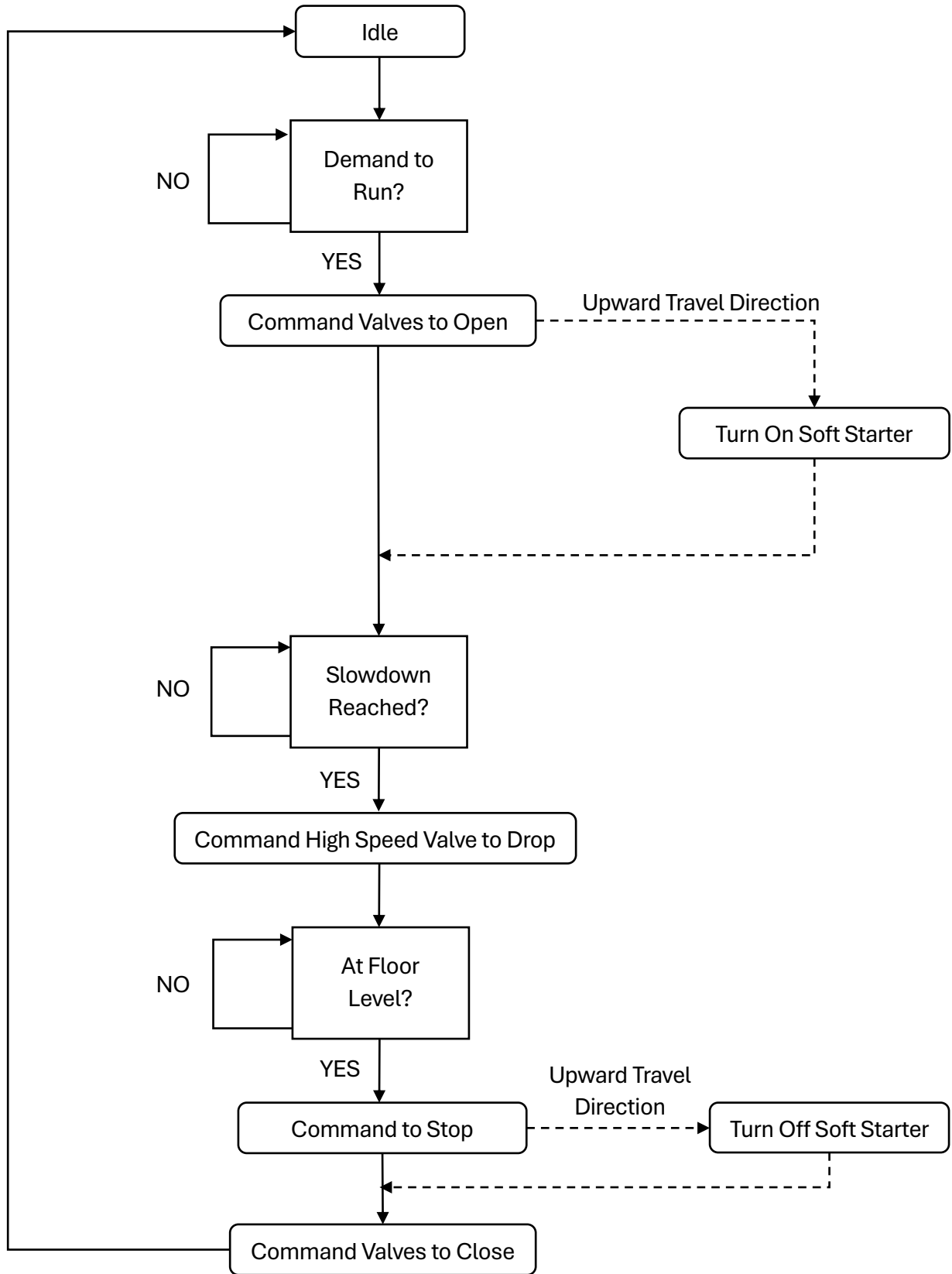

Figure 412: Car Movement

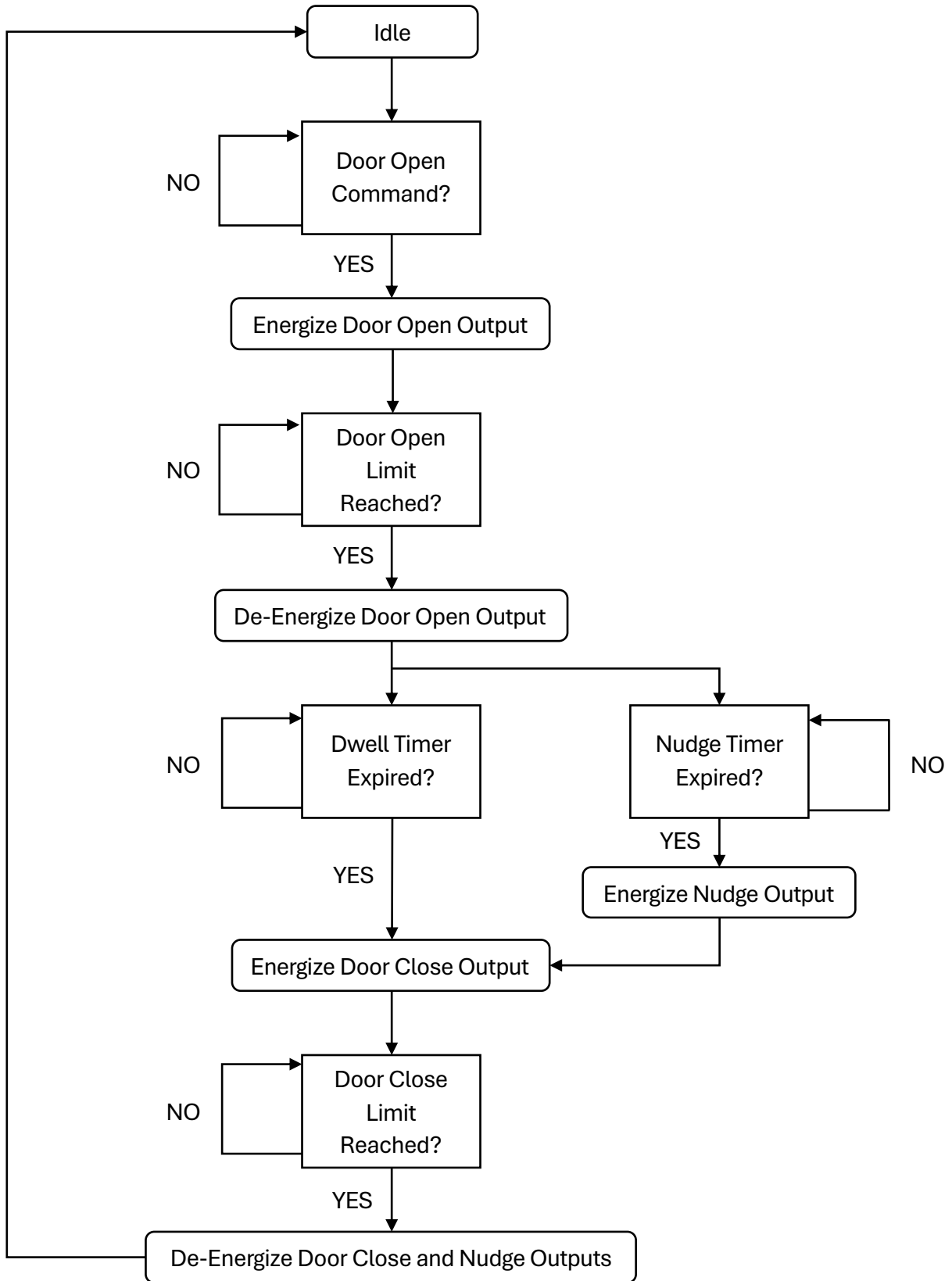

Figure 413: Door Operation

28 Miscellaneous

The controller is bound by the set parameters. The miscellaneous parameters are the general parameters to control other variables within the elevator.

28.1 Bypass Term Limit

The bypass terminal limit allows the car to go beyond the terminal limits set by the user during inspection mode.

The following procedure describes how to bypass terminal limits.

1. Navigate to MAIN MENU | SETUP | MISCELLANEOUS (See Figure 59).
2. From the Miscellaneous menu, scroll and select Bypass Term Limits.

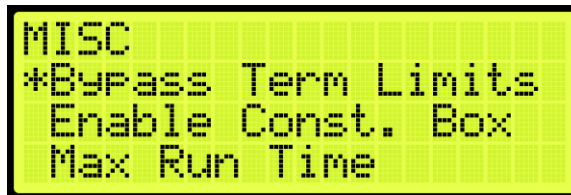

Figure 414: MISCELLANEOUS Menu – Bypass Term Limits

3. From the BYPASS TERM LIMITS menu, scroll and select On to bypass terminal limits.

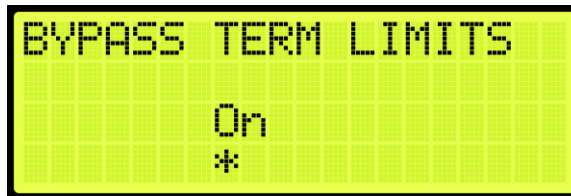

Figure 415: BYPASS TERM LIMITS Menu

4. Scroll right and press Save.

28.2 Enable Construction Box

When the Enable Construction Box is set to enable, the CUP and CDN inputs on the MR Board are used to move the car. Verify 24 VDC is wired directly to the CEN input. If not, then 24VDC must be jumped to CEN.

The following procedure describes how to enable the construction box.

1. Navigate to MAIN MENU | SETUP | MISCELLANEOUS (See Figure 59).
2. From the MISCELLANEOUS menu, scroll and select Enable Construction Box.



Figure 416: MISCELLANEOUS Menu – Enable Construction Box

3. From the ENABLE CONSTRUCTION BOX menu, scroll and select On to enable the construction box.

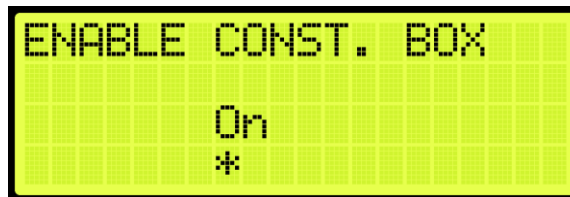

Figure 417: ENABLE CONSTRUCTION BOX Menu

4. Scroll right and press Save.

28.3 Maximum Run Time

The maximum run time is the maximum time that the car can run floor to floor.

The following procedure describes how to set the maximum run time.

1. Navigate to MAIN MENU | SETUP | MISCELLANEOUS (See Figure 59).
2. From the MISCELLANEOUS menu, scroll and select Maximum Run Time.

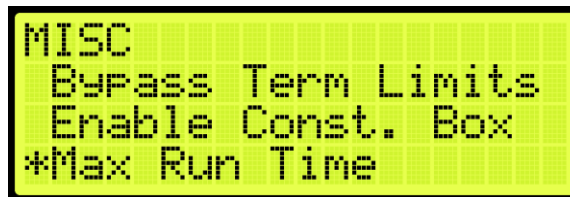

Figure 418: MISCELLANEOUS Menu – Max Run Time

3. From the MAXIMUM RUN TIME menu, set the maximum time the car runs before a fault occurs.



Figure 419: MAXIMUM RUN TIME Menu

4. Scroll right and press Save.

28.4 CT Insp. Req. IC

If required, an IC inspection can be performed prior to CT inspection.

The following procedure describes how to enable the CT inspection.

1. Navigate to MAIN MENU | SETUP | MISCELLANEOUS (See Figure 59).
2. From the MISCELLANEOUS menu, scroll and select CT Insp. Req. IC.



Figure 420: MISCELLANEOUS Menu – CT Insp. Req. IC

3. From the IC REQ FOR CT menu, scroll and select On to enable CT inspection.



Figure 421: IC REQ FOR CT Menu

4. Scroll right and press Save.

28.5 Dis. IdleTrvArrow

The arrow shown on hall call is dependent upon the idle travel arrow. If it is set to On, the arrow shows the direction that the car traveled to the floor. If set off, the arrow shows the direction of travel.

The following procedure describes how to disable the travel arrow.

1. Navigate to MAIN MENU | SETUP | MISCELLANEOUS (See Figure 59).
2. From the MISCELLANEOUS menu, scroll and select Disable IdleTrvArrow.



Figure 422: MISCELLANEOUS Menu – Disable IdleTrvArrow

3. From the DISABLE IDLE TRV ARROW menu, scroll and select Off to disable the direction arrow.



Figure 423: DISABLE IDLE TRV ARROW Menu

4. Scroll right and press Save.

28.6 Enable Latches Car Calls

When enabled, the car call button latches a car call.

The following procedure describes how to enable latching to a car call.

1. Navigate to MAIN MENU | SETUP | MISCELLANEOUS (See Figure 59).
2. From the MISCELLANEOUS menu, scroll and select Enable Latches CC.



Figure 424: MISCELLANEOUS Menu – Enable Latches CC

3. From the ENABLE LATCHES Car Call menu, scroll and select On to enable car call latching.



Figure 425: ENABLE LATCHES Car Call Menu

4. Scroll right and press Save.

28.7 Car To Lobby Floor

When the input for Car to Lobby Floor is active, the signal overrides all hall calls and car calls and goes straight to the selected floor.

The following procedure describes how to select the car to lobby floor.

1. Navigate to MAIN MENU | SETUP | MISCELLANEOUS (See Figure 59).
2. From the MISCELLANEOUS menu, scroll and select Car To Lobby Floor.

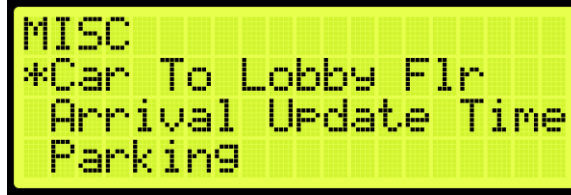

Figure 426: MISCELLANEOUS Menu – Car To Lobby Floor

- From the CAR TO LOBBY FLOOR menu, scroll and select the lobby floor the car automatically travels to.

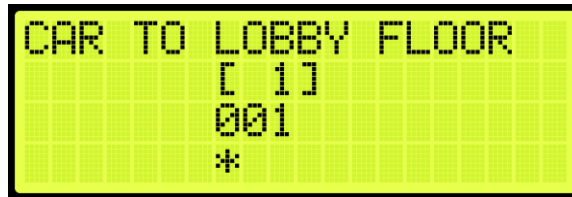

Figure 427: CAR TO LOBBY FLOOR Menu

- Scroll right and press Save.

28.8 Enable Pit Inspection

Enables the Pit Inspection operation on the controller. Input 501 on the MR board must be activated by disconnecting the 24 V, and parameter Enable_Pit_Inspection (01-37) should be set to ON to enable pit inspection operation. DIP 4B must also be enabled to use the operation.

28.9 Parking

Parking moves the car to a certain floor after an X amount of time, where X is the parking timer.

28.9.1 GUI Parking

When enabled, dynamic parking is set through the DAD unit using a GUI interface. After a car has been idle for a set period of time, the car travels to a designated floor, according to the hall call history, and parks. Although the car is parked, the car immediately answers all hall and car calls.

Dynamic parking can be set for multiple cars within a group. If a rule is set for multiple cars, then there is a primary and secondary designated floor for the cars to park at. If the car that is parked at a primary floor answers a car or hall call, the car parked at the secondary floor moves to the primary designated floor. If one of the cars within the group remains idle for a set period of time, that car travels to the secondary designated floor.

For more information, see the *Hydro:Evolved GUI Manual*.

The following procedure describes how to enable dynamic parking using the DAD unit.

- Navigate to MAIN MENU | SETUP | MISCELLANEOUS (See Figure 59).

- From the MISCELLANEOUS menu, scroll and select Parking.



Figure 428: MISCELLANEOUS Menu – Parking

- From the PARKING menu, scroll and select GUI Parking.

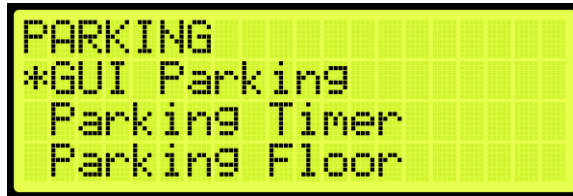

Figure 429: GUI PARKING Menu – GUI Parking

- From the ENABLE GUI PARKING menu, scroll and select if parking is enabled by the DAD unit.



Figure 430: ENABLE GUI PARKING Menu

- Scroll right and press Save.

28.9.2 Parking Timer

The parking timer is the time a car remains idle with no command before it begins parking.

The following procedure describes how to set the parking timer.

- Navigate to MAIN MENU | SETUP | MISCELLANEOUS (See Figure 59).
- From the MISCELLANEOUS menu, scroll and select Parking (See Figure 428).
- From the PARKING menu, scroll and select Parking Timer.

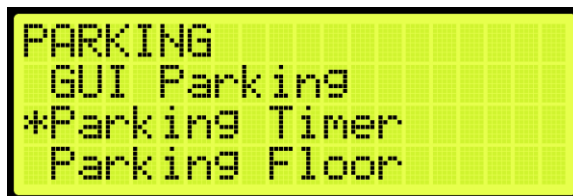

Figure 431: PARKING Menu – Parking Timer

- From the PARKING TIMER menu, set the time prior to parking.

NOTE: If the timer is set to zero, parking will be disabled.

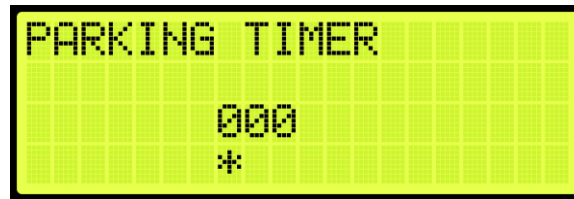

Figure 432: PARKING TIMER Menu

- Scroll right and press Save.

28.9.3 Parking Floor

The parking floor is the floor that the car is parked on.

The following procedure describes how to assign the floor the car is parked on.

- Navigate to MAIN MENU | SETUP | MISCELLANEOUS (See Figure 59).
- From the MISCELLANEOUS menu, scroll and select Parking (See Figure 428).
- From the PARKING menu, scroll and select Parking Floor.

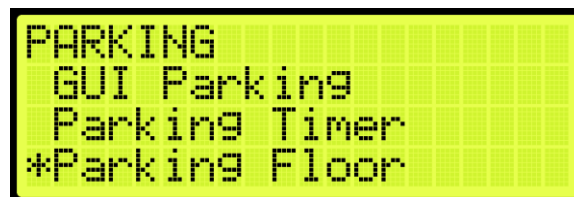

Figure 433: PARKING Menu - Parking Floor

- From the PARKING FLOOR menu, scroll and select the floor the car parks at.

NOTE: PI Labels allows for displaying floor landing as three characters. See Section 28.11 En. 3 Digit PI.

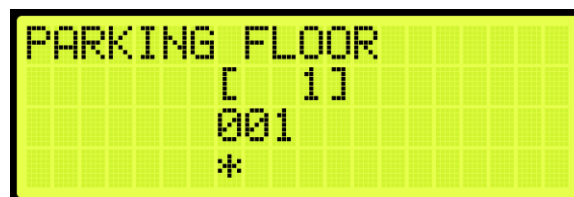

Figure 434: PARKING FLOOR Menu

- Scroll right and press Save.

28.9.4 Parking Door Open

When parked, the car door can stay open or remain closed.

The following procedure describes how to set the doors on a parked car to open.

1. Navigate to MAIN MENU | SETUP | MISCELLANEOUS (See Figure 59).
2. From the MISCELLANEOUS menu, scroll and select Parking (See Figure 428).
3. From the PARKING menu, scroll and select Parking Door Open.

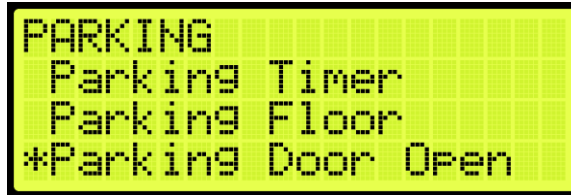

Figure 435: PARKING Menu – Parking Door Open

4. From the PARKING DOOR OPEN menu, scroll and select On to have the car door open when parked.

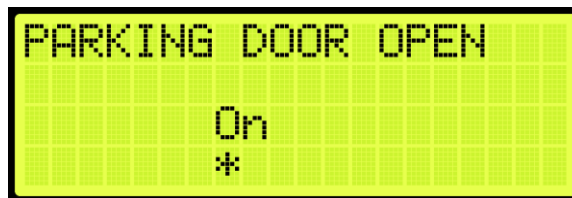

Figure 436: PARKING DOOR OPEN Menu

5. Scroll right and press Save.

28.10 OOS

Elevators can be taken Out Of Service (OOS) for maintenance and other situations.

28.10.1 Disable OOS

The Disable OOS feature prevents the car from ever going into the Out of Service mode of operation or faulting out with OOS regardless of the Hourly Fault Limit or OOS input being active.

The following procedure describes how to disable OSS.

1. Navigate to MAIN MENU | SETUP | MISCELLANEOUS (See Figure 59).
2. From the MISCELLANEOUS menu, scroll and select OOS.



Figure 437: MISCELLANEOUS Menu – OOS

3. From the OOS menu, scroll and select Disable OOS.

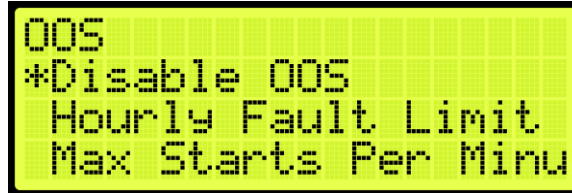

Figure 438: OOS Menu – Disable OOS

4. From the DISABLE OOS menu, scroll and select if out of service is disabled.



Figure 439: DISABLE OOS Menu

5. Scroll right and press Save.

28.10.2 Hourly Fault Limit

The hourly fault limit is the number of faults allowed per hour prior to the car going out of service. The car remains out of service until the hour window elapses.

The following procedure describes how to set hourly fault limit.

1. Navigate to MAIN MENU | SETUP | MISCELLANEOUS (See Figure 59).
2. From the MISCELLANEOUS menu, scroll and select OOS (See Figure 437).
3. From the OOS menu, scroll and select Hourly Fault Limit.

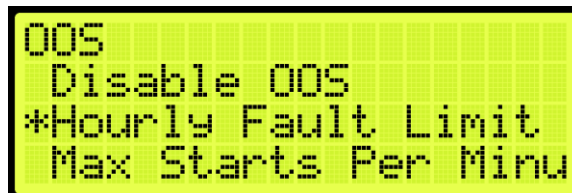

Figure 440: OOS Menu – Hourly Fault Limit

4. From the HOURLY FAULT LIMIT menu, set the number of logged faults allowed per hour.

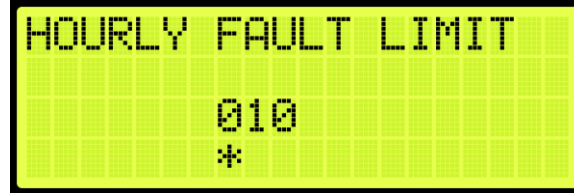

Figure 441: HOURLY FAULT LIMIT Menu

5. Scroll right and press Save.

28.10.3 Maximum Starts Per Minute

The maximum starts per minute is the number of times a car starts a run-in automatic operation within the maximum amount of runs per minute. If additional runs are attempted, the car goes out of service until the hour window elapses.

The following procedure describes how to set the maximum starts per minute.

1. Navigate to MAIN MENU | SETUP | MISCELLANEOUS (See Figure 59).
2. From the MISCELLANEOUS menu, scroll and select OOS (See Figure 437).
3. From the OOS menu, scroll and select Maximum Starts Per Minute.

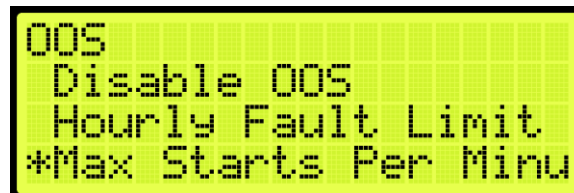

Figure 442: OOS Menu – Maximum Starts Per Minute

4. From MAXIMUM STARTS PER MINUTE menu, adjust the value as required for the maximum runs per minute.

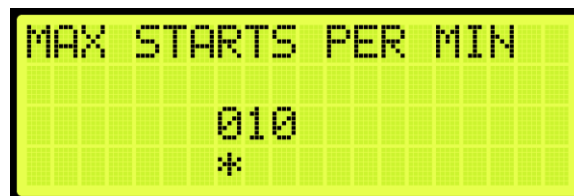

Figure 443: MAXIMUM STARTS PER MINUTE Menu

5. Scroll right and press Save.

28.10.4 Disable PI OOS

When disabled, the OOS does not flash on the PI when the car is out of group.

The following procedure describes how to disable the PI OOS.

1. Navigate to MAIN MENU | SETUP | MISCELLANEOUS (See Figure 59).
2. From the MISCELLANEOUS menu, scroll and select OOS (See Figure 437).
3. From the OOS menu, scroll and select Disable PI OOS.



Figure 444: OOS Menu – Disable PI OOS

4. From the DISABLE PI OOS menu, scroll and select the On to disable the PI OOS.

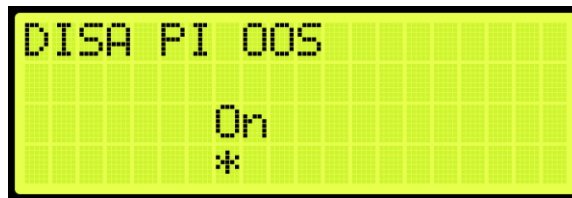

Figure 445: DISABLE PI OOS Menu

5. Scroll right and press Save.

28.11 En. 3 Digit PI

The enable 3 Digit PI allows for the use of 3-characters as opposed to the default of 2 characters for displaying PI labels.

The following procedure describes how to enable the PI to display 3-digit increments.

1. Navigate to MAIN MENU | SETUP | MISCELLANEOUS (See Figure 59).
2. From the MISCELLANEOUS menu, scroll and select Enable 3 Digit PI.



Figure 446: MISCELLANEOUS Menu – Enable 3 Digit PI

3. From the ENABLE 3 DIGIT PI menu, scroll and select On to enable 3-digit PI.



Figure 447: ENABLE 3 DIGIT PI Menu

4. Scroll right and press Save.

28.12 Payment Passcode

The payment password is the controller password that is required for normal operation.

The following procedure describes how to enter the payment passcode.

1. Navigate to MAIN MENU | SETUP | MISCELLANEOUS (See Figure 59).
2. From the MISCELLANEOUS menu, scroll and Payment Passcode.

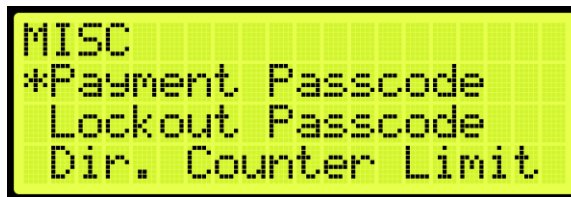

Figure 448: MISCELLANEOUS Menu – Payment Passcode

3. From the PAYMENT PASSCODE menu, enter the payment passcode.

NOTE: the passcode will be given after payment has been made.



Figure 449: PAYMENT PASSCODE Menu

4. Scroll right and press Save.

28.13 Lockout Passcode

The lockout passcode is a screen lockout which restricts access to allowed elevator personnel.

The following procedure describes how to set the lockout passcode.

NOTE: if the lockout passcode has been set, the controller will trigger the lockout passcode request in two cases - after 30 seconds of inactivity while on the Home Page and after 15 minutes of inactivity while inside the MAIN MENU.

1. Navigate to MAIN MENU | SETUP | MISCELLANEOUS (See Figure 59).
2. From the MISCELLANEOUS menu, scroll and select Lockout Passcode.

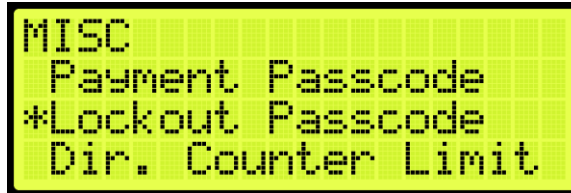

Figure 450: MISCELLANEOUS Menu – Lockout Passcode

3. From the LOCKOUT PASSCODE menu, enter the lockout passcode.

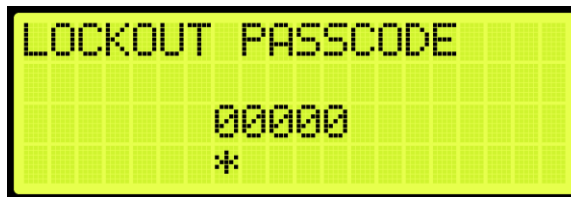

Figure 451: LOCKOUT PASSCODE Menu

4. Scroll right and press Save.

28.14 Direction Counter Limit

The "Direction Counter Trip Reset" feature will take the car out of service once it registers a total number of direction changes equal to a predefined value. Each change represents a shift in the travel direction. See the *Hydro:Evolved Testing Procedures* document.

The following procedure describes how to set the maximum number of direction changes.

1. Navigate to MAIN MENU | SETUP | MISCELLANEOUS (See Figure 59).
2. From the MISCELLANEOUS menu, scroll and select Dir. Counter Limit.

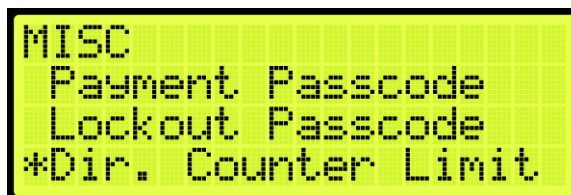

Figure 452: MISCELLANEOUS Menu – Dir. Counter Limit

3. From the ENTER ACCESS CODE menu, enter the access code.

NOTE: the access code is the payment passcode (see Section 28.12 Payment Passcode).

For jobs using software releases older than 65L0, contact Technical Support to request User Manual version 1.11.



Figure 453: ENTER ACCESS CODE Menu

- From the DIR. COUNTER LIMIT menu, set the maximum number of direction changes desired.



Figure 454: DIR. COUNTER LIMIT Menu

- Scroll right and press Save.

28.15 Direction Change Delay

The direction change delay is the time before a car begins looking at car calls or hall calls in the opposite direction to allow for the passengers to enter car calls in the same direction the car was traveling.

The following procedure describes how to set the direct change delay.

- Navigate to MAIN MENU | SETUP | MISCELLANEOUS (See Figure 59).
- From the MISCELLANEOUS menu, scroll and select Direction Change Delay.

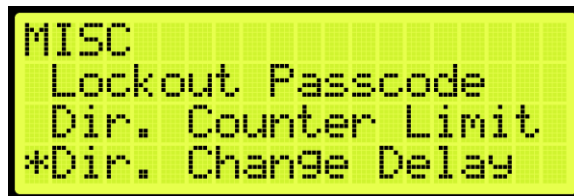

Figure 455: MISCELLANEOUS Menu – Direct Change Delay

- From the DIRECT CHANGE DELAY menu, set the delay time for the car to change directions.

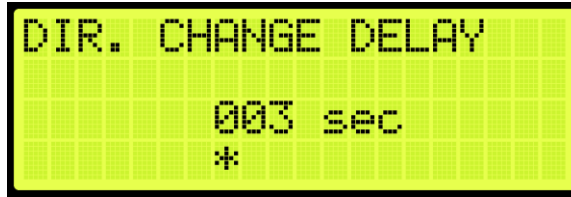

Figure 456: DIRECT CHANGE DELAY Menu

4. Scroll right and press Save.

28.16 Default

The default settings are the original settings within the controller.

28.16.1 Default Floors

The user has the option to restore the original learned floors.

The following procedure describes how to select default floors.

1. Navigate to MAIN MENU | SETUP | MISCELLANEOUS (See Figure 59).
2. From the MISCELLANEOUS menu, scroll and select Default.

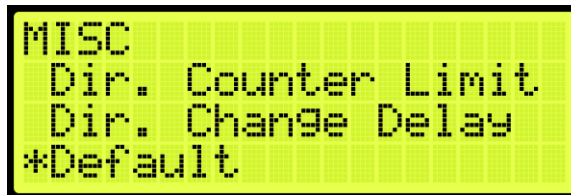

Figure 457: MISCELLANEOUS Menu – Default

3. From the DEFAULT menu, scroll and select Default Floors.



Figure 458: DEFAULT Menu – Default Floors

4. From the DEFAULT FLOORS menu, select whether to restore floors to default before the learn process or not.

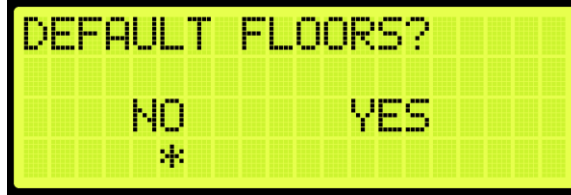

Figure 459: DEFAULT FLOORS Menu

- From the DEFAULT FLOORS menu, select Yes to default floors.

NOTE: if not defaulting floors, select NO to back out.

Only the Learned floor values are defaulted as shown in the figure below.

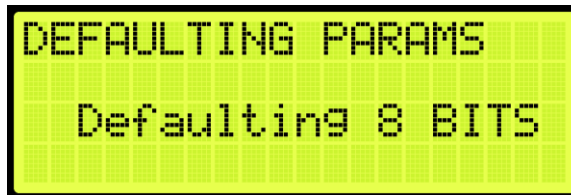

Figure 460: DEFAULTING PARAMS Menu

- When the system has completed defaulting all parameters, the DEFAULTING PARAMS menu displays Parameters Defaulted as shown in the figure below.

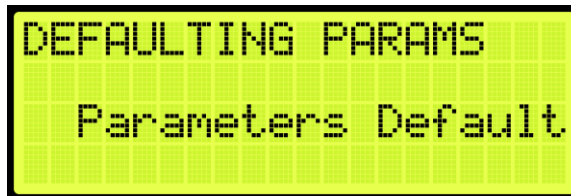

Figure 461: DEFAULTING PARAMS Menu – Parameters Defaulted

28.16.2 Default S-Curve

The user has the option restore the original Digital S-curve Technology™ (U.S. Patent Pending).

The following procedure describes how to select default S-curve.

- Navigate to MAIN MENU | SETUP | MISCELLANEOUS (See Figure 59).
- From the MISCELLANEOUS menu, scroll and select Default (See Figure 457).
- From the DEFAULT menu, scroll and select Default S-Curve.



Figure 462: DEFAULT Menu – Default S-Curve

- From the DEFAULT S-CURVE menu, select whether to restore original Digital S-curve Technology™ (U.S. Patent Pending) or not.

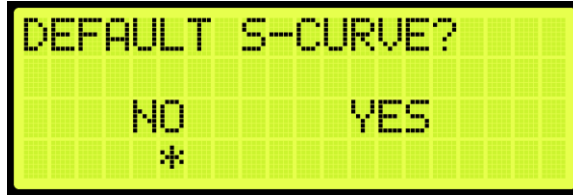

Figure 463: DEFAULT S-CURVE Menu

- From the DEFAULT S-CURVE menu, select YES to default Digital S-curve Technology™ (U.S. Patent Pending).
NOTE: if not defaulting Digital S-curve Technology™ (U.S. Patent Pending), select NO to back out. The system automatically defaults all parameters (See Figure 460).
- When the system has completed defaulting all parameters, the DEFAULTING PARAMS menu displays Parameters Defaulted (See Figure 461).

28.16.3 Default Run Timers

The user has the option to restore the original run timers.

The following procedure describes how to select default run timers.

- Navigate to MAIN MENU | SETUP | MISCELLANEOUS (See Figure 59).
- From the MISCELLANEOUS menu, scroll and select Default (See Figure 457).
- From the DEFAULT menu, scroll and select Default Run Timers.

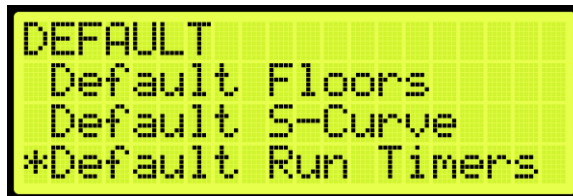

Figure 464: DEFAULT Menu – Default Run Timers

- From the DEFAULT RUN TIMERS menu, select whether to restore original run timers or not.

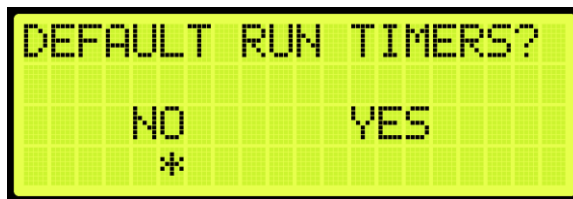

Figure 465: DEFAULT RUN TIMERS? Menu

- From the DEFAULT RUN TIMERS menu, select Yes to default run timers.

NOTE: if not defaulting run timers, select NO to back out.

Only the Learned floor values are defaulted (See Figure 460).

- When the system has completed defaulting all parameters, the DEFAULTING PARAMS menu displays Parameters Defaulted (See Figure 461).

28.16.4 Default I/O

The user has the option to restore original inputs and outputs.

The following procedure describes how to select default I/O.

- Navigate to MAIN MENU | SETUP | MISCELLANEOUS (See Figure 59).
- From the MISCELLANEOUS menu, scroll and select Default (See Figure 457).
- From the DEFAULT menu, scroll and select Default I/O.

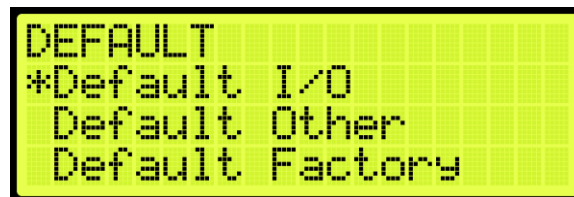

Figure 466: DEFAULT Menu – Default I/O

- From the DEFAULT I/O menu, select whether to restore original inputs and outputs or not.

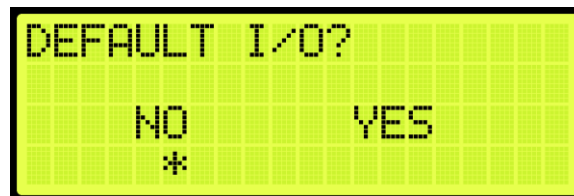

Figure 467: DEFAULT I/O Menu

- From the DEFAULT I/O menu, select Yes to default I/O.

NOTE: if not defaulting I/O, select NO to back out.

The system automatically defaults all parameters (See Figure 460).

- When the system has completed defaulting all parameters, the DEFAULTING PARAMS menu displays Parameters Defaulted (See Figure 461).

28.16.5 Default Other

The user has the option of defaulting other parameters within the system back to the original factory settings.

The following procedure describes how to default other parameters.

- Navigate to MAIN MENU | SETUP | MISCELLANEOUS (See Figure 59).

2. From the MISCELLANEOUS menu, scroll and select Default (See Figure 457).
3. From the DEFAULT menu, scroll and select Default Other.



Figure 468: DEFAULT Menu – Default Other

4. From the DEFAULT OTHER menu, scroll and select whether to default other settings or not.

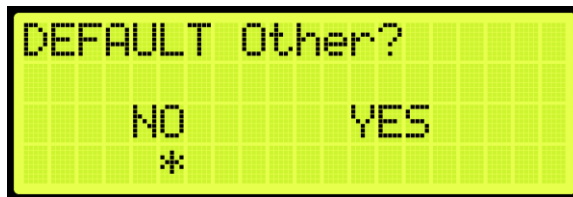

Figure 469: DEFAULT Other Menu

5. From the DEFAULT OTHER menu, select Yes to default other.

NOTE: if not defaulting other, select NO to back out.

The system automatically defaults all parameters (See Figure 460).

6. When the system has completed defaulting all parameters, the DEFAULTING PARAMS menu displays Parameters Defaulted (See Figure 461).

28.16.6 Default Factory

The user has the option to restore original factory settings.

The following procedure describes how to select default factory.

1. Navigate to MAIN MENU | SETUP | MISCELLANEOUS (See Figure 59).
2. From the MISCELLANEOUS menu, scroll and select Default (See Figure 457).
3. From the DEFAULT menu, scroll and select Default Factory.

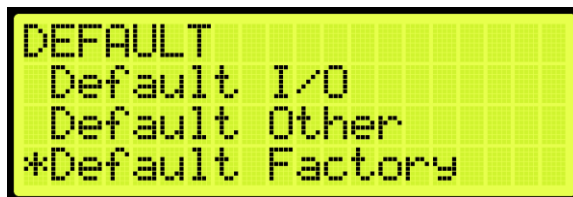

Figure 470: DEFAULT Menu – Default Factory

4. From the DEFAULT FACTORY menu, select whether to restore the original factory settings or not.

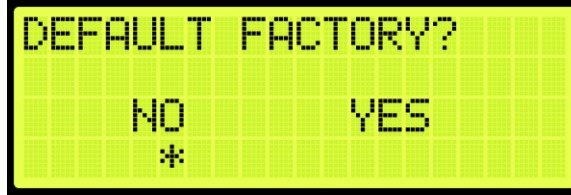

Figure 471: DEFAULT FACTORY Menu

- From the DEFAULT FACTORY menu, select Yes to default factory.

NOTE: if not defaulting factory, select NO to back out.

The system automatically defaults all parameters (See Figure 460).

- When the system has completed defaulting all parameters, the DEFAULTING PARAMS menu displays Parameters Defaulted (See Figure 461).

28.16.7 Default FRAM

When Default FRAM is set to On, the FRAM chip automatically resets. This in turn clears the fault and alarm logs, latched faults, emergency bits and run counters.

The following procedure describes how to default FRAM.

- Navigate to MAIN MENU | SETUP | MISCELLANEOUS (See Figure 59).
- From the MISCELLANEOUS menu, scroll and select Default (See Figure 457).
- From the DEFAULT menu, scroll and select Default FRAM.

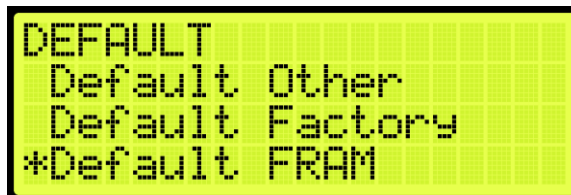

Figure 472: DEFAULT Menu – Default FRAM

- From the DEFAULT FRAM menu, scroll and select On to reset the FRAM chip.

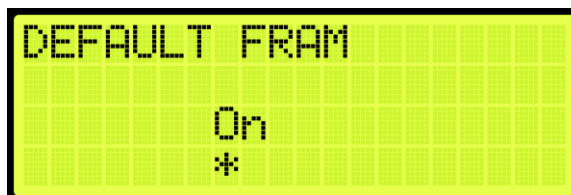

Figure 473: DEFAULT FRAM Menu

- Scroll right and press Save.

28.17 Reset Service

The Reset Service feature, when activated, puts the car out of service after a user-defined maximum number of trips.

To set the maximum number of trips before the car goes out of service:

1. Navigate to MAIN MENU | DEBUG | EDIT PARAMETERS (See Figure 65).
2. Refer to the *Hydro:Evolved Parameter List*:
 - i. set the Reset Service Code.
 - ii. set the maximum Number of HC Trips.

28.18 Replay Feature

The Replay Feature allows the user to display the state of the car before, during, and after a fault/alarm event occurs.

NOTE: if the total time range of an event exceeds 90 seconds, the replay feature will create multiple events for the same case.

The Replay Feature permits the user to filter the required options to track, including car position, car speed, faults, and alarms. The user can select multiple faults/alarms to track simultaneously.

Additionally, the user can view the car data at any specific instant within the event. The car data includes the floor label, position, car speed, motion, and the states of the inputs and outputs.

The user also has the option to download the event and view it in full-screen mode.

See the *C4 & Hydro Evolved GUI Manual* for detailed instructions on how to employ the Replay Feature.

28.19 Smartrise Air Mobile Application

The Smartrise Air mobile application provides a remote interface for performing software updates without physical connections. It automatically scans for and identifies nearby controller units, streamlining the connection process and eliminating the need for manual pairing and complex setup procedures. The latest software updates are downloaded directly from the cloud to the app, ensuring that the controller operates with the most up-to-date features and improvements.

29 Swing Operation

The swing operation takes a car out of the group and allows it to answer calls from the swing riser. The car will complete the car call demand and go to the swing hall call.

29.1 Configuring Swing Operation Input

If swing is activated by a switch, the inputs to the controller must be entered for swing operation. The following procedure describes how to configure the inputs for swing operation.

1. Navigate to MAIN MENU | SETUP | SETUP I/O (Figure 56).
2. From the SETUP I/O, scroll and select Setup Inputs (See Figure 179).
3. From the SELECT BOARD menu, scroll and select the board that is going to be assigned (See Figure 180)
4. From the Input menu, scroll and select an unused input (See Figure 390)
NOTE: the X input is a representation of a number between 1-8.
5. Scroll right.
6. Scroll and select Auto Operation.

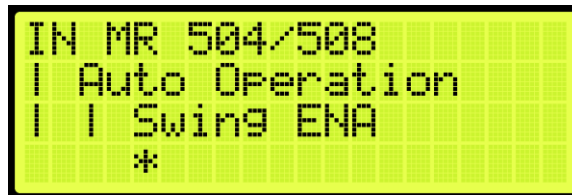

Figure 474: Input Menu – Enable Swing

7. Scroll right.
8. Scroll and select Enable Swing (See Figure 474)
9. Scroll right and press Save.
10. Wire the key switch to the input.

When 24 VDC is supplied to the input, the car enters Swing Operation and takes calls only from the designated riser.

29.2 Calls Enable Swing

The following procedure describes how to configure swing operation to be activated by the swing riser call.

1. Navigate to MAIN MENU | SETUP | SWING (See Figure 62).
2. From the SWING menu, scroll and select Calls Enable Swing.

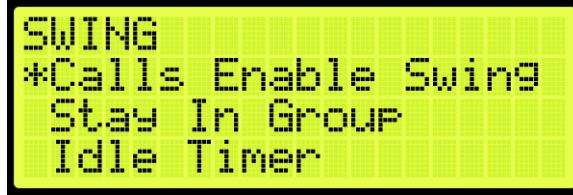

Figure 475: SWING Menu – Calls Enable Swing

- From the CALLS ENABLE menu, scroll and select On.



Figure 476: CALLS ENABLE Menu

- Scroll right and press Save.

29.3 Swing Opening

A swing door is used when in a high traffic area. The door opens or closes automatically. Swing openings can be activated for multiple landings.

The following procedure describes how to set which landings are set for front or rear swing opening.

- Navigate to MAIN MENU | SETUP | DOOR SETUP (See Figure 57).
- From the DOORS menu, scroll and select Swing Openings (Front or Rear).

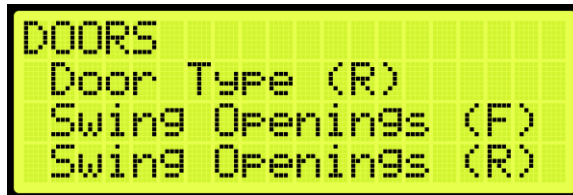

Figure 477: DOORS Menu – Swing Openings (Front or Rear)

- From the SWING DOOR OPENINGS menu, scroll and select which landings are set for swing opening.



Figure 478: SWING DOOR OPENINGS Menu

4. Scroll right and press Save.

29.4 Swing Call Mask

Swing call mask identifies which function set of hall boards are seen as special swing hall calls. Swing calls put the swing car on swing operation.

The following procedure describes how to set swing call mask.

1. Navigate to MAIN MENU | SETUP | GROUP SETUP (See Figure 61).
2. From the GROUP SETUP menu, scroll and select Swing Call Mask.



Figure 479: GROUP SETUP Menu – Swing Call Mask

3. From the HALL SWING MASK menu, scroll and select the cars set for swing operation.

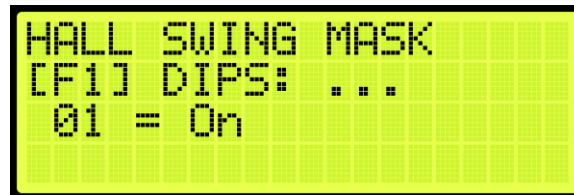

Figure 480: HALL SWING MASK Menu

4. Scroll right and press Save.

29.5 Stay Active in Group

When a car is setup to stay active in the group, the car can be operated by any riser in the system during swing operation. The setup for inputs is required. If the inputs are not setup for the controller, see Section 29.1 Configuring Swing Operation Input.

The following procedure describes how to configure the car to stay active in the group.

1. Navigate to MAIN MENU | SETUP | SWING (See Figure 62).
2. From the Swing menu, scroll and select Stay In Group.



Figure 481: SWING Menu – Stay In Group

- From the STAY IN GROUP menu, scroll and select On.

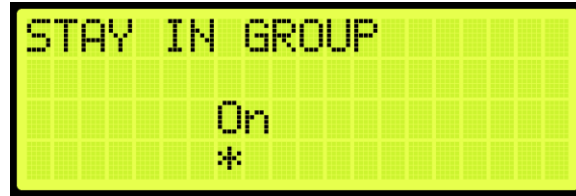

Figure 482: STAY IN GROUP Menu

- Scroll right and press Save.

29.6 Idle Timer

The idle timer is set to depict the amount of time the car stays in swing operation after all calls have been serviced. The setup for inputs is required. If the inputs are not setup for the controller, see Section 29.1 Configuring Swing Operation Input.

The following procedure describes how to configure the idle timer.

- Navigate to MAIN MENU | SETUP | SWING (See Figure 62).
- From the SWING menu, scroll and select Idle Timer.

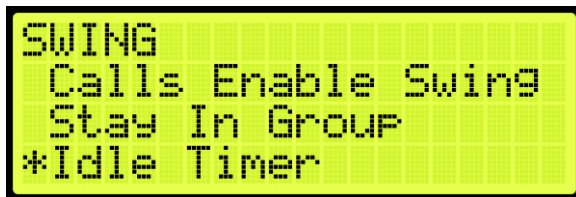

Figure 483: SWING Menu – Idle Timer

- From the IDLE TIMER menu, set the time the car stays idle.

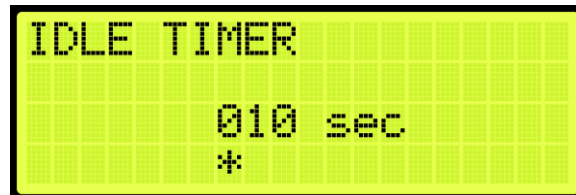

Figure 484: IDLE TIMER Menu

4. Scroll right and press Save.

30 Timers

Timers are used for energy conservation.

30.1 Fan & Light Timer

The fan and light timer is the amount of time the fan and lights are on.

The following procedure describes how to set the time the fan and lights are on.

1. Navigate to MAIN MENU | SETUP | MISCELLANEOUS (See Figure 59).
2. From the MISCELLANEOUS menu, scroll and select Fan & Light Timer.



Figure 485: MISCELLANEOUS Menu – Fan & Light Timer

3. From the FAN & LIGHT TIMER menu, set the time the fan and lights are on.



Figure 486: FAN & LIGHT TIMER Menu

4. Scroll right and press Save.

30.2 External Fan Timer

The external fan timer is the time for the fan and lights to be on while the car is idle.

The following procedure describes how to set the time the fan and lights are on.

1. Navigate to MAIN MENU | SETUP | MISCELLANEOUS (See Figure 59).
2. From the MISCELLANEOUS menu, scroll and select External Fan Timer.



Figure 487: MISCELLANEOUS Menu – External Fan Timer

- From the MR FAN TIMER menu, set the time the fan and lights are on while the car is idle.



Figure 488: MR FAN TIMER Menu

- Scroll right and press Save.

30.3 Arrival Update Time

The arrival update time is the time set to update the lantern outputs prior to arriving at a floor.

The following procedure describes how to set the arrival update time.

- Navigate to MAIN MENU | SETUP | MISCELLANEOUS (See Figure 59).
- From the MISCELLANEOUS menu, scroll and select Arrival Update Time.

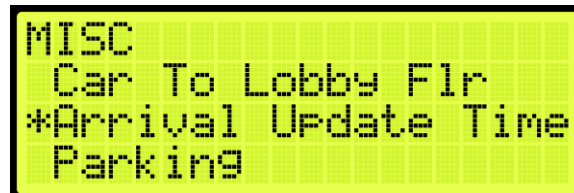

Figure 489: MISCELLANEOUS Menu – Arrival Update Time

- From the ARRIVAL UPDATE TIME menu, set the time to update lantern outputs.

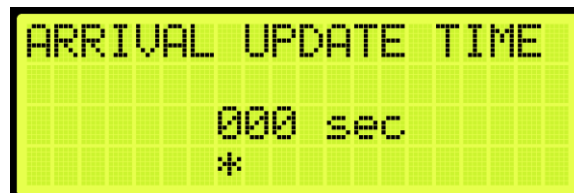

Figure 490: ARRIVAL UPDATE TIME Menu

- Scroll right and press Save.

31 Safety

Safety measures are taken to prevent personal injury and to protect the equipment.

31.1 Speed Deviation

Speed deviation is used to detect the difference between the variation of the actual and expected movement of the car.

31.1.1 Timeout

A designated timer is set between the detected and expected time the car travels. If the detected variance is greater than the set timeout, the car shuts down.

The following is an example of setting up the speed deviation timeout.

1. Navigate to MAIN MENU | SETUP | SAFETY (See Figure 56).
2. From the SAFETY menu, scroll and select Speed Deviation.



Figure 491: SAFETY Menu - Speed Deviation

3. From the SPEED DEVIATION menu, scroll and select Timeout.

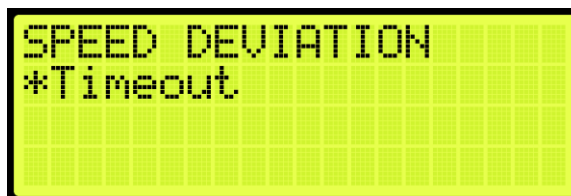

Figure 492: SPEED DEVIATION Menu – Timeout

4. From the TIMEOUT menu, set the time of the threshold.

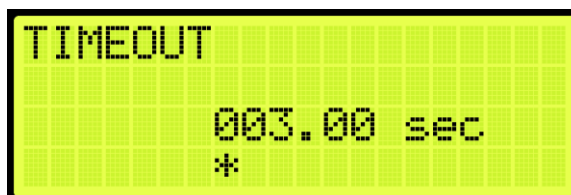

Figure 493: TIMEOUT Menu

5. Scroll right and press Save.

31.2 Lock Clip

Lock clip time is the amount of time the controller disregards an open hall lock. This prevents intermittent interlock faults.

The following is an example of setting up lock clip.

1. Navigate to MAIN MENU | SETUP | SAFETY (See Figure 56).
2. From the SAFETY menu, scroll and select Lock Clip.



Figure 494: SAFETY Menu – Lock Clip

3. From the LOCK CLIP TIMER menu, set the time of the lock.



Figure 495: LOCK CLIP TIMER Menu

4. Scroll right and press Save.

31.3 General ODL

The General overspeed debounce limit sets the distance for miscellaneous limits.

The following is an example of setting up the general ODL.

1. Navigate to MAIN MENU | SETUP | SAFETY (See Figure 56).
2. From the SAFETY menu, scroll and select General ODL.



Figure 496: SAFETY Menu – General ODL

3. From the GENERAL ODL menu, enter the general debounce limit.



Figure 497: GENERAL ODL Menu

4. Scroll right and press Save.

31.4 NTS ODL

The NTS ODL is used to reduce the sensitivity of the NTS trip points. Increase this value by 3-5 points to reduce nuisance tripping if elevator tracking is off at the terminal floors.

The following procedure describes how to set the NTS ODL.

1. Navigate to MAIN MENU | SETUP | Safety (See Figure 56).
2. From the SAFETY menu, scroll and select NTS ODL.

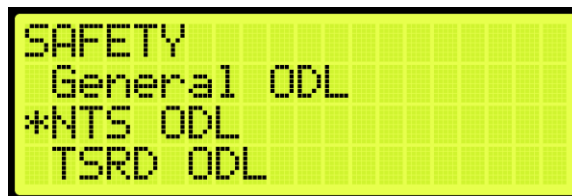

Figure 498: SAFETY Menu – NTS ODL

3. From the NTS ODL menu, enter the NTS debounce limit.



Figure 499: NTS ODL Menu

4. Scroll right and press Save.

31.5 TSRD ODL

The TSRD ODL sets the distance to the bottom of the top door zone magnet. If the car passes this point at more than 80% of contract speed, power will be cut to the valves and pump motor to prevent hitting the stop ring at contract speed.

The following procedure describes how to set the TSRD ODL.

1. Navigate to MAIN MENU | SETUP | Safety (See Figure 56).
2. From the SAFETY menu, scroll and select TSRD ODL.

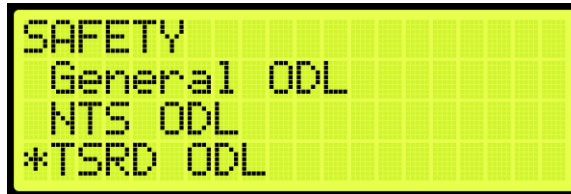

Figure 500: SAFETY Menu –TSRD ODL

3. From the NTS ODL menu, enter the NTS debounce limit.



Figure 501: TSRD ODL Menu

4. Scroll right and press Save.

32 Emergency

Emergency situations can occur due to natural or other conditions.

32.1 Emergency Power

Emergency power is activated when the mainline power is interrupted. The generator power allows elevators to continue operation in this case. During emergency power, the Digital S-curve Technology™ (U.S. Patent Pending) is set to the emergency power profile.

Parameter 08-0145 defines if the emergency group priority is running on a single group or multiple group operation. For the list of parameters, see the *Hydro:Evolved Parameter List*.

The table below lists the Inputs Used by the Controller for Emergency Power.

Table 51: Inputs Used by the Controller for Emergency Power

Option	Description
On Emergency Power	Signals the controller that the car is on emergency power. When this input is active, the controller stops the car until the Generator Up to Speed is active.
Generator Up to Speed	Signals the controller that the generator is supplying the power to operate the car(s). When this input is active, the car goes into normal operation if selected by the user or dispatcher.
Pre-Transfer	Changes from generator power to normal power or vice versa. When this input is active, the controller comes to a stop to the nearest landing and opens the door.

32.1.1 Earthquake Modes

Earthquake events are the highest priority during emergency situations. The enable earthquake can be enabled for when seismic activity is high.

The earthquake events are:

- Earthquake Seismic Event
- Earthquake Counter-Weight Derail Event

See Section 32.2 Earthquake for more information.

32.1.2 Privileged Modes

Each car operates independently. If a car remains idle during recall, the car is put out of service until the emergency power service cycle is complete. Privileged modes of car operation can postpone car recalls until they become idle for 2-3 minutes set by parameter 08-0232. If emergency power recall is repeated for any reason, privileged cars which have already postponed the original recall cycle, will not be delayed again. For the list of parameters, see the *Hydro:Evolved Parameter List*.

The following is a list of privileged modes in order of operation:

- Fire Phase 1 and Phase 2 Operation
- EMS Phase 1 and Phase 2 Operation
- Cars in Manual Modes of Operation (Inspection states)
- Independent Service Operation
- Attendant Operation

32.1.2.1 Fire Phase 1 and Phase 2 Operation

Fire Phase 1 and Phase 2 are modes of operation when smoke or heat is detected. See Section 32.3 Fire for more information.

32.1.2.2 EMS Phase 1 and Phase 2 Operation

EMS Phase 1 and Phase 2 are modes of operation to allow for medical personnel to take control of the elevator during a medical emergency. See Section 32.5 EMS for more information.

32.1.2.3 Cars in Manual Modes of Operation (Inspection States)

Cars are idle for 2-3 minutes from the time emergency power has been activated. Once a car is switched from or to (MR, CT, IC, HA) inspection while emergency power is active, the whole emergency power recall and allocation process is repeated using the new car configuration.

32.1.2.4 Independent/Attendant Service Operation

Independent/Attendant service operation cars remain idle for 2-3 minutes from when the emergency power cycle began. The cars are not recalled but are considered normal cars when allocated. If allocated, these cars return to their original mode of operation.

32.1.3 Other Modes

- **Cars OOS:** when a car is OOS, the car is temporarily removed from service. The OOS condition can occur if the doors remain open for a longer period of allotted time. If the OOS condition is safety related, the car is treated as earthquake mode cars in which a car moves to the nearest landing, opens the doors, and then shuts down. These cars are not recalled. If the OOS condition is caused by a switch, the car will still recall.
- **Normal Allocated Cars:** after all recalls are complete, these cars close their doors and respond to hall and car calls normally. While emergency power is active, their movement is restricted to the defined emergency power speed.
- **Cars Not Allocated:** cars that are not allocated for normal operation leave the car on the recall landing with the doors open.

32.1.4 Single Group Operation

When the system is running on emergency power, each car within a single car group is individually recalled to a defined recall floor. Once all active cars have been recalled, a defined number of cars (set by parameter 08-0186), are placed back into operation at the defined emergency power speed. For the list of parameters, see the *Hydro:Evolved Parameter List*.

32.1.4.1 Number of Active Cars

A selected number of cars are set to operate during emergency power.

The following procedure describes how to set the number of active cars.

1. Navigate to MAIN MENU | SETUP | E-Power (See Figure 63).
2. From the E-POWER menu, scroll and select Number Active Cars.

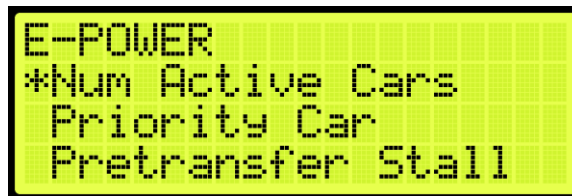

Figure 502: E-POWER Menu – Number Active Cars

3. From the NUMBER ACTIVE CARS menu, scroll and select the number of active cars.



Figure 503: Number Active Cars Menu

4. Scroll right and press Save.

32.1.5 Multiple Group Operation

Emergency power handles the car recalls and the number of cars placed into normal operation across multiple interconnected groups. The multiple group operation works the same as the single group during emergency power whereas a group of cars are given a priority assignment (set by parameter 08-0129) and a limited number of cars per group (set by parameter 08-0186) that can be activated for normal operation. Parameter 08-0230 sets the number of cars that can be activated for normal operation across all groups. For the list of parameters, see the *Hydro:Evolved Parameter List*.

Car recalls, privileged mode cars and earthquake operations, and cars placed into operation are coordinated between the groups. This coordination limits the number of active cars which can be in motion. These operations are restricted based on the number of cars allowed to run. Positioning of cars are resolved within all groups. As cars complete their movement, car operations are adjusted so that more cars can be repositioned.

All groups wait for cars with privileged modes to be idle for the allotted 2-3 minutes before performing any recalls. Recalls are performed one car at a time in ascending order starting with the first group. When all cars have been recalled, cars can be allocated for normal operation. Normal operations are assigned based on the following sequence:

- Privileged mode cars
- Maximum number of cars within an interconnecting group
- Individual group

If the overall allocation count is reached, the groups with higher group priority values may not be able to assign any cars.

32.1.5.1 Priority Car

A main car is set to run during emergency power.

The following procedure describes how to set the priority car.

1. Navigate to MAIN MENU | SETUP | E-Power (See Figure 63).
2. From the E-POWER menu, scroll and select the Priority Car.

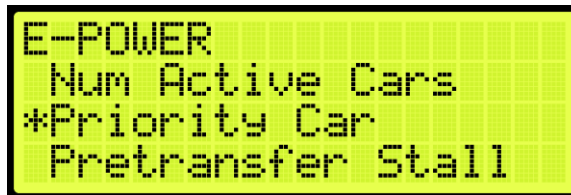

Figure 504: E-POWER Menu – Priority Car

3. From the PRIORITY CAR menu, scroll and select the priority car.

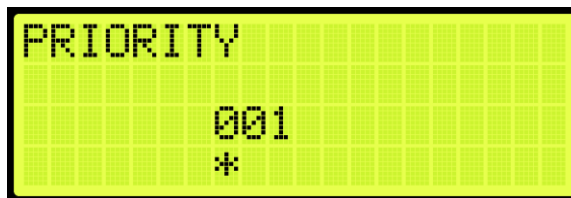

Figure 505: PRIORITY CAR Menu

4. Scroll right and press Save.

32.1.6 Recall

Cars that are not in any of the above modes of operations are recalled to their recall landing. If during recall, the car does not move for 30 seconds, the recall is transferred to another car.

The recall landing is also affected by the presence of a flood sensor. If this sensor is active and the recall floor is below the defined flood floor, the cars are recalled to the flood floor. See Section 32.4 Flood for more information.

After all recalls have been completed, cars are allocated for normal operation.

32.1.6.1 Pretransfer Stall

During emergency power and pretransfer stall enabled, the car stops at the current position. If disabled, the car stops at the nearest landing.

The following procedure describes how to enable or disable the pretransfer stall.

1. Navigate to MAIN MENU | SETUP | E-POWER (See Figure 63).
2. From the E-POWER MENU, scroll and select the Pretransfer Stall.

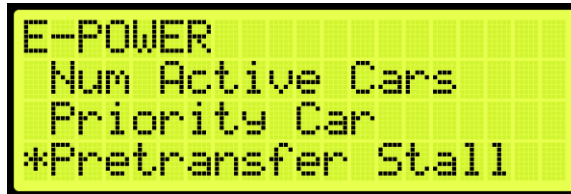

Figure 506: E-POWER Menu – Pretransfer Stall

3. From the PRETRANSFER STALL menu, scroll and select if the pretransfer stall is enabled or disabled.



Figure 507: PRETRANSFER STALL Menu

4. Scroll right and press Save.

32.1.6.2 Recall Failure

If a car is given a recall command, a timer is started for that car. This timer accumulates the time in which the car does not move during recall. If this idle time is more than 30 seconds, the car is placed OOS and a recall is attempted on another car. The recall process continues to all other cars regardless of a single or multiple group configuration prior to going back to the cars that failed recall. Once all recall attempts have been made, the car which failed recall is given a second chance. If the car fails recall a second time, the car is placed OOS and not allowed to operate.

32.1.7 Intergroup Communication

Communication between groups is facilitated by the addition of a Riser board configured as Riser 4. The Riser 4 board DIP switches 1, 2, and 8 are on.

CAN 1 of a Riser 4 board is connected to the car-group GROUP network.

CAN 2 of a Riser 4 board is connected in parallel to another CAN 2 of a Riser 4 board in each of the interconnected groups. This is referred to as the Intergroup network.

During emergency power, the Riser 4 board turns off all hall network traffic on CAN 2 and only maintains the Intergroup network.

The Riser 4 board continues to communicate with other Riser 4 boards from other groups and is notified when another group has gone offline. If the group does not respond within 30 seconds, the system marks that group as offline.

If a group is added to the Intergroup during emergency power, all groups repeat the recall process.

32.2 Earthquake

The Earthquake Seismic Event and Earthquake Counter-Weight Derail Event resolve the car position based on the event.

Cars that need to move to a landing during Emergency Power operation cannot all move at once. The number of cars that can move at the same time is limited only by the specified number of cars. As cars reach their landing, the doors open, and other cars can be recalled.

32.2.1 Enable Earthquake

When seismic activity has been detected, the car stops at the nearest floor to allow passengers to safely exit the car.

The following procedure describes how to enable earthquake mode.

1. Navigate to MAIN MENU | SETUP | EARTHQUAKE (See Figure 59).
2. From the EARTHQUAKE menu, scroll and select Enable EQ.



Figure 508: EARTHQUAKE Menu – Enable EQ

3. From the ENABLE EQ menu, scroll and select enable earthquake.



Figure 509: ENABLE EQ Menu

4. Scroll right and press Save.

32.2.2 Set CW Position

Counterweights are used to provide an equal and opposite force to the weight of a payload. The position of the counterweight is set for the mid-point location of the hoistway.

The following procedure describes how to set the counterweight position.

1. Manually move the car to the mid-point location.
2. Navigate to MAIN MENU | SETUP | EARTHQUAKE (See Figure 59).
3. From the Earthquake menu, scroll and select Set CW POS.



Figure 510: EARTHQUAKE Menu – Set CW POS

4. From the Save CW Position menu, scroll and select the position. This will store the current position of the elevator as the mid-point.

NOTE: place the car in CT Inspection Mode and move the car so it overlaps with the center of the counterweight.

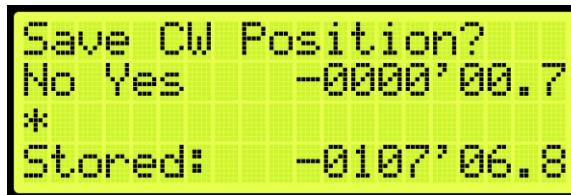

Figure 511: Save CW Position Menu

5. Scroll right and press Save.

32.2.3 Earthquake Status

The status of the fire and earthquake display the input status for the selected fire, smoke, and earthquake options.

The following procedure describes how to view the fire/earthquake status.

1. Navigate to MAIN MENU | STATUS | INPUTS (See Figure 45).
2. From the INPUTS BY FUNCTION menu, scroll and select Fire/Earthquake.

```

INPUTS BY FUNCTION
Contactors
Auto Operation
*Fire/Earthquake
  
```

Figure 512: INPUTS BY FUNCTION Menu – Fire/Earthquake

- From the FIRE/EARTHQUAKE menu, view the status of all selected fire and earthquake emergency services.

```

FIRE/EARTHQUAKE
[X] Smoke Snsr @ HA
[X] Smoke Snsr @ MR
[X] Smk Snsr @ Main
  
```

Figure 513: FIRE/EARTHQUAKE Menu

32.3 Fire

Fire Phase 1 and Phase 2 allows for controlling a car(s) during a fire situation.

- Fire Phase 1:** smoke has been detected and Fire Phase 1 is activated manually (by key or switch) or automatically (smoke sensor). The car(s) moves to a designated landing with car doors open. If the landing is where the smoke is detected, the car(s) moves to an alternate landing. In case the fire is in the machine room, the shunt operation removes main power to the controller. The MR board activates an external shunt disconnect device after the car has moved to the designated recall floor and doors are open.

The shunt operation is as follows:

- Smoke sensor activates.
 - The car(s) move to the recall floor and open the doors.
 - The shunt output activates and opens the Shunt Bypass switch, removing power to the main disconnect.
- Fire Phase 2:** a key switch is used to allow fire fighters or emergency personnel to gain control from inside the elevator.

32.3.1 Main Recall

The main recall is where the car is recalled to a main recall floor during a fire.

32.3.1.1 Main Recall Floor

The following procedure describes how to set the designated landing.

- Navigate to MAIN MENU | SETUP | FIRE (See Figure 58).

- From the FIRE SERVICE menu, scroll and select Main Recall.



Figure 514: FIRE SERVICE Menu – Main Recall

- From the MAIN RECALL menu, scroll and select Floor.



Figure 515: MAIN RECALL Menu – Floor

- From the MAIN RECALL FLOOR menu, enter the recall floor.

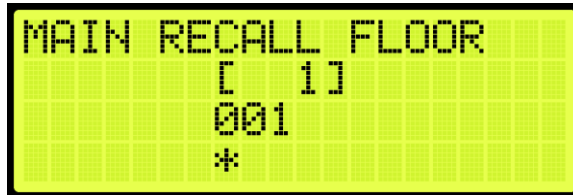

Figure 516: MAIN RECALL FLOOR Menu

- Scroll right and press Save.

32.3.1.2 Main Recall Door

The following procedure describes how to set which door opens during a fire.

- Navigate to MAIN MENU | SETUP | FIRE (See Figure 58).
- From the FIRE SERVICE menu, scroll and select Main Recall (See Figure 514).
- From the MAIN RECALL menu, scroll and select Opening.

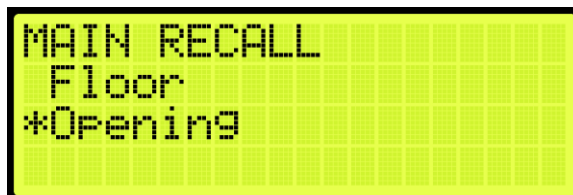

Figure 517: MAIN RECALL Menu – Opening

- From the MAIN RECALL DOOR menu, enable or disable rear door.



Figure 518: MAIN RECALL DOOR Menu

- Scroll right and press Save.

32.3.2 Alternate Recall

Sensors indicate if the fire is at the designated main recall floor. If the fire is on that floor, the car then travels to a designated alternate landing.

32.3.2.1 Alternate Recall Floor

The following procedure describes how to set the designated landing.

- Navigate to MAIN MENU | SETUP | FIRE (See Figure 58).
- From the FIRE SERVICE menu, scroll and select Alt Recall.



Figure 519: FIRE SERVICE Menu – Alt Recall

- From the ALT RECALL menu, scroll and select Floor.



Figure 520: ALT RECALL Menu – Floor

- From the ALT RECALL FLOOR menu, enter the recall floor.



Figure 521: ALT RECALL FLOOR Menu

5. Scroll right and press Save.

32.3.2.2 Alternate Recall Door

The following procedure describes how to set the alternate recall door.

1. Navigate to MAIN MENU | SETUP | FIRE (See Figure 58).
2. From the FIRE SERVICE menu, scroll and select Alt Recall (See Figure 519).
3. From the ALT RECALL menu, scroll and select Opening.



Figure 522: ALT RECALL Menu – Opening

4. From the ALT RECALL DOOR menu, enable or disable rear door.



Figure 523: ALT RECALL DOOR Menu

5. Scroll right and press Save.

32.3.3 Main Smoke

The main smoke is where the car is recalled to a designated landing when smoke has been detected in the main lobby.

32.3.3.1 Main or Alternate

The car travels to the main landing when smoke has been detected. If configured and the smoke is on that floor, the car travels to an alternate landing.

The following procedure describes if the car travels to the main or alternate designated landing when smoke has been detected.

1. Navigate to MAIN MENU | SETUP | FIRE (See Figure 58).
2. From the FIRE SERVICE menu, scroll and select Main Smoke Action.

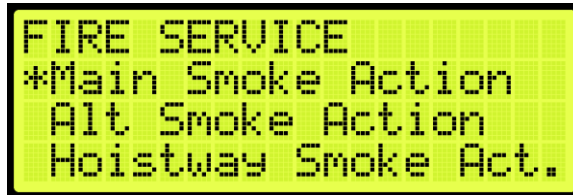

Figure 524: FIRE SERVICE Menu – Main Smoke Action

3. From the MAIN SMOKE ACTION menu, scroll and select Main or Alt.



Figure 525: MAIN SMOKE ACTION Menu – Main or Alt

4. From the USE ALT FLOOR menu, scroll and select if the alternate or main floor is configured for main smoke.

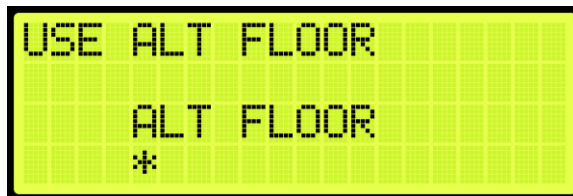

Figure 526: USE ALT FLOOR Menu

5. Scroll right and press Save.

32.3.3.2 Flash Fire Hat

If the fire flash hat been enabled during main smoke, a fire hat symbol on the panel flashes when smoke has been detected.

The following procedure describes how to enable the flash fire hat.

1. Navigate to MAIN MENU | SETUP | FIRE (See Figure 58).
2. From the FIRE SERVICE menu, scroll and select Main Smoke Action (See Figure 524).
3. From the MAIN SMOKE ACTION menu, scroll and select Flash Fire Hat.



Figure 527: MAIN SMOKE ACTION Menu – Flash Fire Hat

4. From the FLASH FIRE HAT menu, scroll and select On.



Figure 528: FLASH FIRE HAT Menu

5. Scroll right and press Save.

32.3.3.3 Shunt Trip

A shunt output is designed to trip a breaker shutting off the main power to the controller in case of a fire in the main lobby.

The following procedure describes how to set up the parameters in case smoke is detected in the main lobby.

1. Navigate to MAIN MENU | SETUP | FIRE (See Figure 58).
2. From the FIRE SERVICE menu, scroll and select Main Smoke Action (See Figure 524).
3. From the MAIN SMOKE ACTION menu, scroll and select Shunt Trip.



Figure 529: MAIN SMOKE ACTION Menu – Shunt Trip

4. From SHUNT ON RECALL menu, scroll and select On.

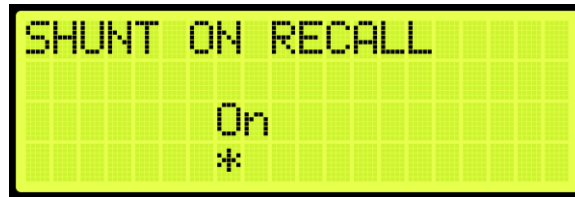

Figure 530: SHUNT ON RECALL Menu

5. Scroll right and press Save.

32.3.4 Alternate Smoke

The alternate smoke is where the car is recalled to an alternate designated landing when smoke has been detected in the main lobby.

32.3.4.1 Main or Alternate

The car travels to the main landing when smoke has been detected. If configured and the smoke is on that floor, the car travels to an alternated landing.

The following procedure describes if the car travels to the main or alternate designated landing when smoke has been detected.

1. Navigate to MAIN MENU | SETUP | FIRE (See Figure 58).
2. From the FIRE SERVICE menu, scroll and select Alt Smoke Action.



Figure 531: FIRE SERVICE Menu – Alt Smoke Action

3. From the ALT SMOKE ACTION menu, scroll and select Main or Alt.



Figure 532: ALT SMOKE ACTION Menu – Main or Alt

4. From the USE ALT FLOOR menu, scroll and select if the alternate or main floor is configured for alternate smoke.

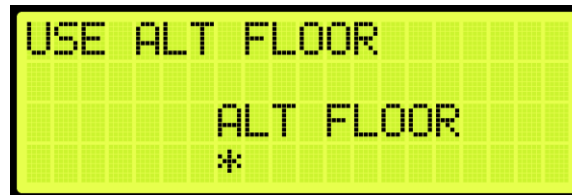

Figure 533: USE ALT FLOOR Menu

5. Scroll right and press Save.

32.3.4.2 Flash Fire Hat

If the fire flash hat been enabled during alternate smoke, a fire hat symbol on the panel flashes when smoke has been detected.

The following procedure describes how to enable the flash fire hat.

1. Navigate to MAIN MENU | SETUP | FIRE (See Figure 58).
2. From the FIRE SERVICE menu, scroll and select Alt Smoke Action (See Figure 531).
3. From the ALT SMOKE ACTION menu, scroll and select Flash Fire Hat.



Figure 534: ALT SMOKE ACTION Menu – Flash Fire Hat

4. From the FLASH FIRE HAT menu, scroll and select On.



Figure 535: FLASH FIRE HAT Menu

5. Scroll right and press Save.

32.3.4.3 Shunt Trip

A shunt output is designed to trip a breaker shutting off the main power to the controller in case of a fire in the main lobby.

The following procedure describes how to set up the parameters in case smoke is detected in the main lobby.

1. Navigate to MAIN MENU | SETUP | FIRE (See Figure 58).
2. From the FIRE SERVICE menu, scroll and select Alt Smoke Action (See Figure 531).
3. From the ALT SMOKE ACTION menu, scroll and select Shunt Trip.



Figure 536: ALT SMOKE ACTION Menu – Shunt Trip

4. From SHUNT ON RECALL menu, scroll and select On.

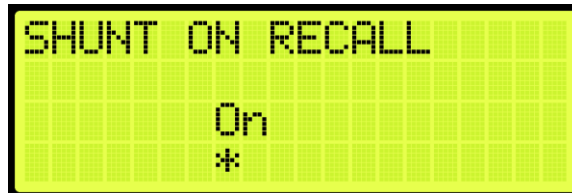

Figure 537: SHUNT ON RECALL Menu

5. Scroll right and press Save.

32.3.5 Hoistway Smoke

The hoistway smoke is where the car is recalled to a designated landing when smoke has been detected in the hoistway.

32.3.5.1 Main or Alternate

The car travels to the main landing when smoke has been detected. If configured and the smoke is on that floor, the car travels to an alternate landing.

The following procedure describes if the car travels to the main or alternate designated landing when smoke has been detected.

1. Navigate to MAIN MENU | SETUP | FIRE (See Figure 58).
2. From the FIRE SERVICE menu, scroll and select Hoistway Smoke Action.



```
FIRE SERVICE
Main Smoke Action
Alt Smoke Action
*Hoistway Smoke Act.
```

Figure 538: FIRE SERVICE Menu – Hoistway Smoke Action

3. From the HOISTWAY SMOKE ACTION menu, scroll and select Main or Alt.



```
HOISTWAY SMOKE ACT.
*Main or Alt
Flash Fire Hat
Shunt Trip
```

Figure 539: HOISTWAY SMOKE ACTION Menu – Main or Alt

4. From the USE ALT FLOOR menu, scroll and select if the alternate or main floor is configured for alternate smoke.

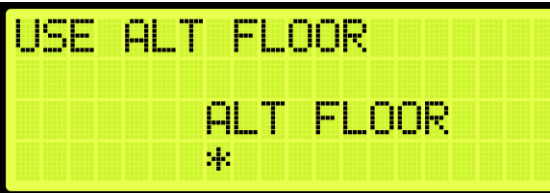

```
USE ALT FLOOR

ALT FLOOR
*
```

Figure 540: USE ALT FLOOR Menu

5. Scroll right and press Save.

32.3.5.2 Flash Fire Hat

If the fire flash hat been enabled during hoistway smoke, a fire hat symbol on the panel flashes when smoke has been detected.

The following procedure describes how to enable the flash fire hat.

1. Navigate to MAIN MENU | SETUP | FIRE (See Figure 58).
2. From the FIRE SERVICE menu, scroll and select Hoistway Smoke Action (See Figure 538).
3. From the HOISTWAY SMOKE ACTION menu, scroll and select Flash Fire Hat.



Figure 541: HOISTWAY SMOKE ACTION Menu – Flash Fire Hat

4. From FLASH FIRE HAT menu, scroll and select On.

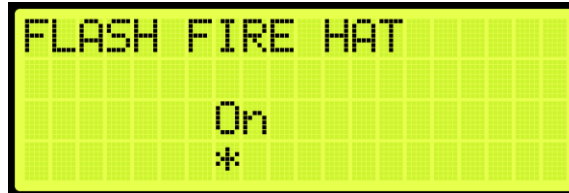

Figure 542: FLASH FIRE HAT Menu

5. Scroll right and press Save.

32.3.5.3 Shunt Trip

A shunt output is designed to trip a breaker shutting off the main power to the controller in case of a fire in the hoistway.

The following procedure describes how to set up the parameters in case smoke is detected in the hoistway.

1. Navigate to MAIN MENU | SETUP | FIRE (See Figure 58).
2. From the FIRE SERVICE menu, scroll and select Hoistway Smoke Action(See Figure 538).
3. From the HOISTWAY SMOKE ACTION menu, scroll and select Shunt Trip.

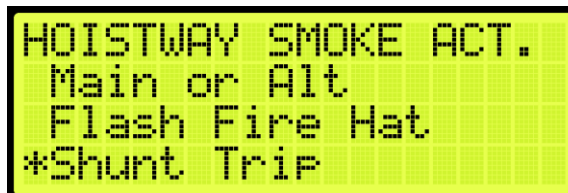

Figure 543: HOISTWAY SMOKE ACTION Menu – Shunt Trip

- From the SHUNT ON RECALL menu, scroll and select On.



Figure 544: SHUNT ON RECALL Menu

- Scroll right and press Save.

32.3.6 MR Smoke

The MR smoke is where the car is recalled to a designated landing when smoke has been detected in the machine room.

32.3.6.1 Main or Alternate

The car travels to the main landing when smoke has been detected. If configured and the smoke is on that floor, the car travels to an alternate landing.

The following procedure describes if the car travels to the main or alternate designated landing when smoke has been detected.

- Navigate to MAIN MENU | SETUP | FIRE (See Figure 58).
- From the FIRE SERVICE menu, scroll and select MR Smoke Action.



Figure 545: FIRE SERVICE Menu – MR Smoke Action

- From the MR SMOKE ACTION menu, scroll and select Main or Alt.



Figure 546: MR SMOKE ACTION Menu – Main or Alt

4. From the USE ALT FLOOR menu, scroll and select if the alternate or main floor is configured for MR Smoke.



Figure 547: USE ALT FLOOR Menu

5. Scroll right and press Save.

32.3.6.2 Flash Fire Hat

If the fire flash hat been enabled during MR smoke, a fire hat symbol on the panel flashes when smoke has been detected.

The following procedure describes how to enable the flash fire hat.

1. Navigate to MAIN MENU | SETUP | FIRE (See Figure 58).
2. From the FIRE SERVICE menu, scroll and select MR Smoke Action (See Figure 545).
3. From the MR SMOKE ACTION menu, scroll and select Flash Fire Hat.



Figure 548: MR SMOKE ACTION Menu – Flash Fire Hat

4. From the FLASH FIRE HAT menu, scroll and select On.



Figure 549: FLASH FIRE HAT Menu

5. Scroll right and press Save.

32.3.6.3 Shunt Trip

A shunt output is designed to trip a breaker shutting off the main power to the controller in case of a fire in the machine room.

The following procedure describes how to set up the parameters in case smoke is detected.

1. Navigate to MAIN MENU | SETUP | FIRE (See Figure 58).
2. From the FIRE SERVICE menu, scroll and select MR Smoke Action (See Figure 545).
3. From the MR SMOKE ACTION menu, scroll and select Shunt Trip.



Figure 550: MR SMOKE ACTION Menu – Shunt Trip

4. From SHUNT ON RECALL menu, scroll and select On.



Figure 551: SHUNT ON RECALL Menu

5. Scroll right and press Save.

32.3.7 Recall Key

The recall key is the key that is used on the panel inside the car and in the hall usually in the main lobby that is used for fire service to control the emergency landing. If the fire flash hat been enabled when using the recall key, a fire hat symbol on the panel flashes on panel.

The following procedure describes how to enable the flash fire hat.

1. Navigate to MAIN MENU | SETUP | FIRE (See Figure 58).
2. From the FIRE SERVICE menu, scroll and select Recall Key.



Figure 552: FIRE SERVICE Menu – Recall Key

3. From the RECALL KEY menu, scroll and select Flash Fire Hat.



Figure 553: RECALL KEY Menu – Flash Fire Hat

4. From the FLASH FIRE HAT menu, scroll and select On.



Figure 554: FLASH FIRE HAT Menu

5. Scroll right and press Save.

32.3.8 PIT Smoke

The PIT smoke is where the car is recalled to a designated landing when smoke has been detected in the pit.

32.3.8.1 Main or Alternate

The car travels to the main landing when smoke has been detected. If configured and the smoke is on that floor, the car travels to an alternate landing.

The following procedure describes if the car travels to the main or alternate designated landing when smoke has been detected.

1. Navigate to MAIN MENU | SETUP | FIRE (See Figure 58).
2. From the FIRE SERVICE menu, scroll and select PIT Smoke.

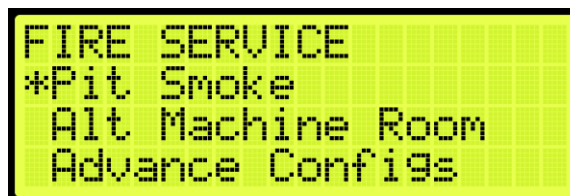

Figure 555: FIRE SERVICE Menu – PIT Smoke

- From the PIT SMOKE menu, scroll and select Main or Alt.



Figure 556: PIT SMOKE Menu – Main or Alt

- From the USE ALT FLOOR menu, scroll and select if the main or alternate floor is used.



Figure 557: USE ALT FLOOR Menu

- Scroll right and press Save.

32.3.8.2 Flash Fire Hat

If the fire flash hat been enabled during PIT smoke, a fire hat symbol on the panel flashes when smoke has been detected.

The following procedure describes how to enable the flash fire hat.

- Navigate to MAIN MENU | SETUP | FIRE (See Figure 58).
- From the FIRE SERVICE menu, scroll and select PIT Smoke (See Figure 555).
- From the PIT SMOKE menu, scroll and select Flash Fire Hat.



Figure 558: PIT SMOKE Menu – Flash Fire Hat

4. From the FLASH FIRE HAT menu, scroll and select On.



Figure 559: FLASH FIRE HAT Menu

5. Scroll right and press Save.

32.3.8.3 Shunt Trip

A shunt output is designed to trip a breaker shutting off the main power to the controller in case of a fire in the machine room.

The following procedure describes how to set up the parameters in case smoke is detected.

1. Navigate to MAIN MENU | SETUP | FIRE (See Figure 58).
2. From the FIRE SERVICE menu, scroll and select PIT Smoke (See Figure 555).
3. From the PIT SMOKE menu, scroll and select Shunt Trip.



Figure 560: PIT SMOKE Menu – Shunt Trip

4. From the SHUNT ON RECALL menu, scroll and select On.

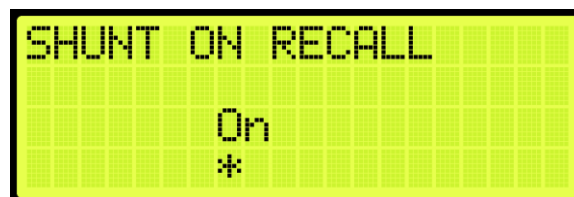

Figure 561: SHUNT ON RECALL Menu

5. Scroll right and press Save.

32.3.9 Alt Machine Room

Alternate machine room parameters are set when a group of elevators have split machine room and hoistway.

32.3.9.1 Enable Alternate Machine Room

When secondary machine room operation is required, the alternate machine room smoke needs to be enabled.

The following procedure describes how to enable the alternate machine room smokes.

1. Navigate to MAIN MENU | SETUP | FIRE (See Figure 58).
2. From the FIRE SERVICE menu, scroll and select Alt. Machine Room.

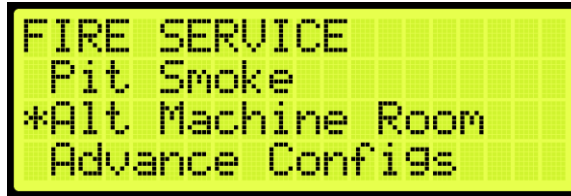

Figure 562: FIRE SERVICE Menu – Alt. Machine Room

3. From the ALT MACHINE ROOM menu, scroll and select Enable Alt. MR.

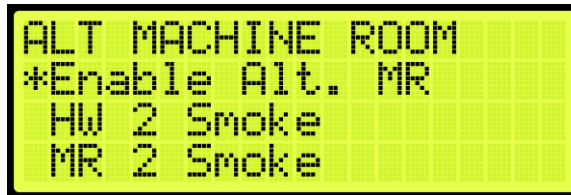

Figure 563: ALT MACHINE ROOM Menu – Enable Alt. MR

4. From the ENABLE ALT MR menu, scroll and select On.

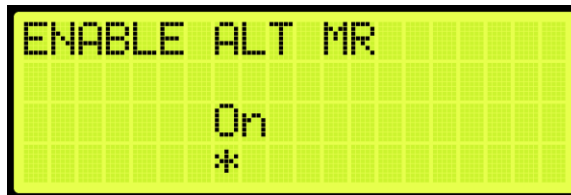

Figure 564: ENABLE ALT MR Menu

5. Scroll right and press Save.

32.3.9.2 Hoistway 2 Smoke

When a group of elevators have a split hoistway, the options for secondary hoistway smoke needs to be enabled.

32.3.9.2.1 Main or Alternate

The following procedure describes how to select if the car goes to main or alternate landing when the HW 2 smoke is triggered.

1. Navigate to MAIN MENU | SETUP | FIRE (See Figure 58).
2. From the FIRE SERVICE menu, scroll and select Alt. Machine Room (See Figure 562).
3. From the ALT MACHINE ROOM menu, scroll and select HW 2 Smoke.

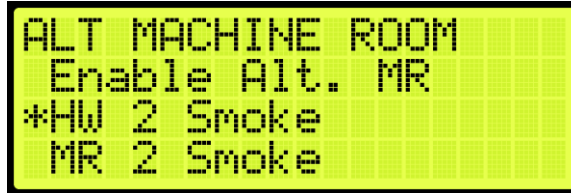

Figure 565: ALT MACHINE ROOM Menu – HW 2 Smoke

4. From the HOISTWAY 2 SMOKE menu, scroll and select Main or Alt.



Figure 566: HOISTWAY 2 SMOKE Menu – Main or Alt

5. From the USE ALT FLOOR menu, scroll to select alternate landing or main recall landing.



Figure 567: USE ALT FLOOR Menu

6. Scroll right and press Save.

32.3.9.2.2 Flash Fire Hat

The following procedure describes how to flash the fire hat when the alternate hoistway smoke is triggered.

1. Navigate to MAIN MENU | SETUP | FIRE (See Figure 58).
2. From the FIRE SERVICE menu, scroll and select Alt. Machine Room (See Figure 562).

3. From the ALT MACHINE ROOM menu, scroll and select HW 2 Smoke (See Figure 565).
4. From the HOISTWAY 2 SMOKE menu, scroll and select Flash Fire Hat.



Figure 568: HOISTWAY 2 SMOKE Menu – Flash Fire Hat

5. From the FLASH FIRE HAT menu, scroll and select On (See Figure 554).
6. Scroll right and press Save.

32.3.9.2.3 Shunt Trip

A shunt output is designed to trip a breaker shutting off the main power to the controller in case of a fire in the machine room.

The following procedure describes how to set up shunt trip when the alternate hoistway smoke is triggered.

1. Navigate to MAIN MENU | SETUP | FIRE (See Figure 58).
2. From the FIRE SERVICE menu, scroll and select Alt. Machine Room (See Figure 562).
3. From the ALT MACHINE ROOM menu, scroll and select HW 2 Smoke (See Figure 565).
4. From the HOISTWAY 2 SMOKE menu, scroll and select Shunt Trip.



Figure 569: HOISTWAY 2 SMOKE Menu – Shunt Trip

5. From the SHUNT ON RECALL menu, scroll and select On.

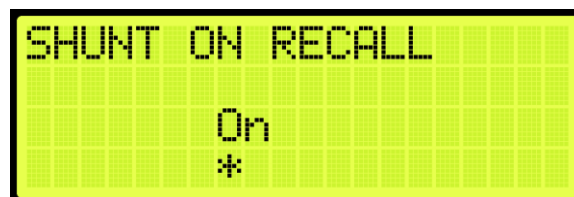

Figure 570: SHUNT ON RECALL Menu

6. Scroll right and press Save.

32.3.9.3 MR 2 Smoke

The MR 2 smoke is the smoke sensor located in the secondary machine room.

32.3.9.3.1 Main or Alt

The following procedure describes how to select if the car goes to main or alternate landing when the MR 2 smoke is triggered.

1. Navigate to MAIN MENU | SETUP | FIRE (See Figure 58).
2. From the FIRE SERVICE menu, scroll and select Alt. Machine Room (See Figure 562).
3. From the ALT MACHINE ROOM menu, scroll and select MR 2 Smoke.



Figure 571: ALT MACHINE ROOM Menu – MR 2 Smoke

4. From the MR 2 SMOKE menu, scroll and select Main or Alt.



Figure 572: MR 2 SMOKE Menu – Main or Alt

5. From the USE ALT FLOOR menu, scroll to select alternate landing or main recall landing (See Figure 567).
6. Scroll right and press Save.

32.3.9.3.2 Flash Fire Hat

The following procedure describes how to flash the fire hat when the alternate Machine room smoke is triggered.

1. Navigate to MAIN MENU | SETUP | FIRE (See Figure 58).
2. From the FIRE SERVICE menu, scroll and select Alt. Machine Room (See Figure 562).
3. From the ALT MACHINE ROOM menu, scroll and select MR 2 Smoke (See Figure 571).

4. From the MR 2 SMOKE menu, scroll and select Flash Fire Hat.



Figure 573: MR 2 SMOKE Menu – Flash Fire Hat

5. From the FLASH FIRE HAT menu, scroll and select On (See Figure 554).
6. Scroll right and press Save.

32.3.9.3.3 Shunt Trip

A shunt output is designed to trip a breaker shutting off the main power to the controller in case of a fire in the machine room.

The following procedure describes how to set up shunt trip when the alternate Machine room smoke is triggered.

1. Navigate to MAIN MENU | SETUP | FIRE (See Figure 562).
2. From the FIRE SERVICE menu, scroll and select Alt. Machine Room (See Figure 562).
3. From the ALT MACHINE ROOM menu, scroll and select MR 2 Smoke (See Figure 571).
4. From the MR 2 SMOKE menu, scroll and select Shunt Trip.



Figure 574: MR 2 SMOKE Menu – Shunt Trip

5. From the SHUNT ON RECALL menu, scroll and select On (See Figure 570).
6. Scroll right and press Save.

32.3.10 Advanced Configs

Advanced configuration is a simple way to configure specific fire parameters within the system. For a description of each parameter, see the *Hydro:Evolved Parameter List*.

The following is a list of the specific parameters that can be configured.

1. FIRE RESET TO EXIT PHASE1

2. DISA DR RESTRICTOR PHASE2
3. FIRE PHASE2 SWING REOPEN DISA
4. FIRE PHASE2 EXIT ONLY AT RECALL FLR
5. FIRE IGNORE LOCKS JUMPED ON PHASE2
6. FIRE OR IC STOP SWITCH KILLS DR ON FIRE MODES
7. FIRE DOL TO EXIT PHASE2
8. FIRE ALLOW RESET WITH ACTIVE SMOKE
9. FIRE HAT FLASH IGNORE ORDER
10. FIRE MOMENTARY DCB
11. FIRE FLASH LOBBY LAMP
12. FIRE REMOTE AND MAIN TO OVERRIDE SMOKE
13. FIRE ENABLE PHE ON PHASE2
14. FIRE DR OPEN ON HOLD
15. DISA BYP IC STOP
16. COURION FIRE1 ACTIVE
17. EMS FIRE 1 ACTIVE
18. BYP FIRESRV
19. FIRE RECALL TO MAIN AFTER PHASE 2
20. FIRE2 SWING REOPEN
21. FIRE DISA LATCH SMOKES
22. FIRE DISA LATCH LOBBY KEY
23. FIRE DISA LTACH MAIN RECALL
24. FIRE RESET ON TRANSITION
25. FIRE EXIT PH2 WITHOUT PH1 RCL
26. FIRE 2 ACTIVE ALWAYS ON DURING FP2
27. AUTORESCUE CLOSE DOORS FIREONLY
28. AUTORESCUE WAITCCTOMOVE CLOSEONFF2OFF
29. CLOSE DOOR WHEN PHE BYPASSED ON FF2
30. FIRE2 BYPASS ON MR AND HA SMOKE
31. FIRE1 DOB HC ENABALED DWELL 1 MIN
32. ONLY EXIT FP1 ON MAIN LANDING

33. FIRE2 CANCEL BUTTON REOPEN DOOR
34. FIRE2 CLOSE DOOR WHEN NO DOB
35. FIRE SWITCH 2 POSITIONS
36. FIRE NO DCL TO EXIT PHASE2
37. FIRE1 RESET EXTINGUISHES LOBBY LAMP AT ALT FLOOR
38. TURN OFF AT RECALL OUTPUT ON FP2
39. ALLOW SHUNT TRIP ON INSPECTION MODE
40. ALLOW SHUNT TRIP ON FIRE I ALTERNATE LANDING
41. ALLOW SHUNT TRIP ON EMS

The following procedure describes how to configure specific parameters listed in Advanced Configuration.

1. Navigate to MAIN MENU | SETUP | FIRE (See Figure 58).
2. From the FIRE SERVICE menu, scroll and select Advanced Configuration.

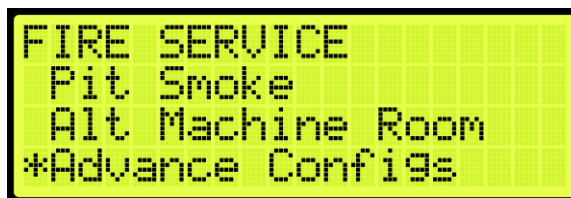

Figure 575: FIRE SERVICE Menu – Advance Configurations

3. From the SMOKE CONFIGURATION menu, scroll and select if the parameter is ON or OFF.

NOTE: the name of the parameter scrolls to the left.



Figure 576: SMOKE CONFIGURATION Menu

4. Scroll right and press Save.

32.4 Flood

Flooding can occur due to natural disasters or due to other incidents, such as broken pipes. When a sensor detects flooding, an alarm is set off and logged.

If this sensor is active, the elevator is limited to traveling to floors above the flood floor set by the user.

32.4.1 Number of Floors

When flooding has been detected, the parameter set for the flood sensor switch sends a signal to notify the controller of the floors to avoid during operation.

The following procedure describes how to set the number of floors the elevator is to avoid from the bottom landing.

1. Navigate to MAIN MENU | SETUP | FLOOD (See Figure 61).
2. From the FLOOD menu, scroll and select Number of Floors.

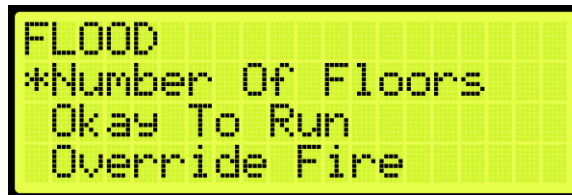

Figure 577: FLOOD Menu – Number of Floors

3. From the NUMBER OF FLOOD FLOORS menu, set the number of floors to avoid. For example, a value of 001 would cause the elevator to avoid the bottom landing.

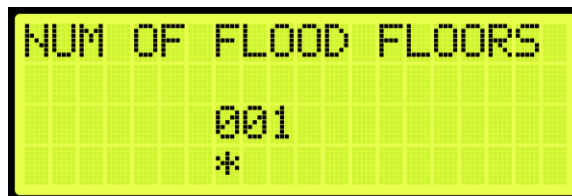

Figure 578: NUMBER OF FLOOD FLOORS MENU

4. Scroll right and press Save.

32.4.2 Okay to Run

The okay to run allows the elevator to continue running in automatic operation above the floors that are flooded.

The following procedure describes how to allow the elevator to continue running above flooded floors.

1. Navigate to MAIN MENU | SETUP | FLOOD (See Figure 61).
2. From the FLOOD menu, scroll and select Okay To Run.

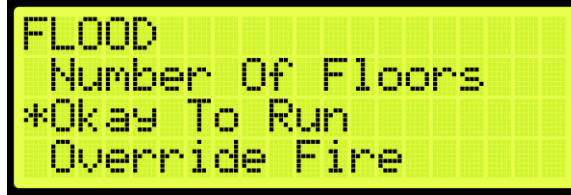

Figure 579: FLOOD Menu – Okay To Run

3. From the OKAY TO RUN menu, scroll and select On to continue running in automatic operation.



Figure 580: OKAY TO RUN Menu

4. Scroll right and press Save.

32.4.3 Override Fire

In emergency situations, it may be necessary to have flooding operation override fire operation.

The following procedure describes how to have flooding override fire.

1. Navigate to MAIN MENU | SETUP | FLOOD (See Figure 61).
2. From the FLOOD menu, scroll and select Override Fire.



Figure 581: FLOOD Menu – Override Fire

3. From the OVERRIDE FIRE menu, scroll and select On for flooding to override fire.



Figure 582: OVERRIDE FIRE Menu

4. Scroll right and press Save.

32.5 EMS

EMS Phase 1 and Phase 2 services allows for operation during medical emergencies.

- **EMS Phase 1:** allows for emergency medical personnel, via a key switch or button on the hall board, to make a hall call. The car skips all floors and goes directly to the designated landing. If a key is not used within the set Phase 1 Exit Delay time (see section 32.5.4 Ph1 Exit Delay) to switch from EMS Phase 1 to EMS Phase 2, the car goes back to normal operation. If a fire occurs, Fire Phase 1 overrides EMS Phase 1.
- **MA EMS 1:** allows for emergency medical personnel, via a key switch or button, to make a hall call to a predefined recall floor. MA EMS 1 is activated via the MA – EMS1 input (see Section 21 Assigning Inputs and Outputs). The Recall Floor should be assigned to parameter 08-0272 or assigned via the user interface (See Section 32.5.6 Ph1 Recall Floor).
- **EMS Phase 2:** a key switch is used to hold the door open according to the set Phase 2 Exit Delay time (see 32.5.5 Ph2 Exit Delay) to allow for the emergency medical team to remove the patient from the car.

32.5.1 AllowPh2WithoutPh1

Medical personnel can set the car to EMS Phase 2 without ever placing the car in Phase 1.

The following procedure describes how to set the AllowPh2WithoutPh1.

1. Navigate to MAIN MENU | SETUP | EMS (See Figure 61).
2. From the EMS menu, scroll and select AllowPh2WithoutPh1.

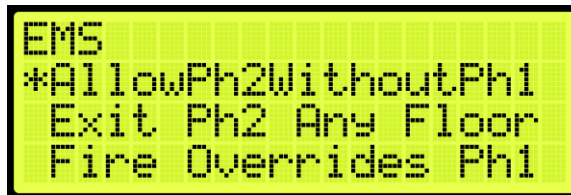

Figure 583: EMS Menu – AllowPh2WithoutPh1

3. From the PH2 WITHOUT PH1 menu, scroll and select if the car is set to run in a medical emergency.

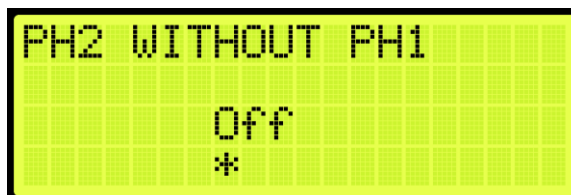

Figure 584: PH2 WITHOUT PH1 Menu

4. Scroll right and press Save.

32.5.2 Exit Ph2 Any Floor

When Exit Ph2 any floor is active, the controller can exit EMS Phase 2 at any floor. If set to On, the car can only exit EMS Phase 2 on the floor where it entered EMS Phase 2.

The following procedure describes how the settings to allow for exit phase 2 at any floor.

1. Navigate to MAIN MENU | SETUP | EMS (See Figure 61).
2. From the EMS menu, scroll and select Exit Ph2 Any Floor.

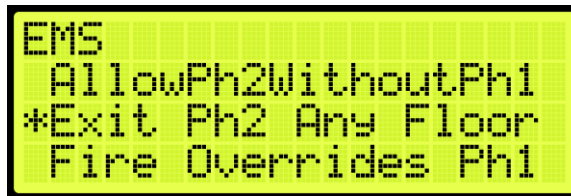

Figure 585: EMS Menu – Exit Ph2 Any Floor

3. From the EXIT PH2 ANY FLOOR menu, scroll and select if the controller can exit phase 2 on any floor.



Figure 586: EXIT PH2 ANY FLOOR Menu

4. Scroll right and press Save.

32.5.3 Fire Overrides Ph1

The following procedure describes how to allow fire to override Phase 1 EMS operation.

1. Navigate to MAIN MENU | SETUP | EMS (See Figure 61).
2. From the EMS menu, scroll and select Fire Overrides Ph1.

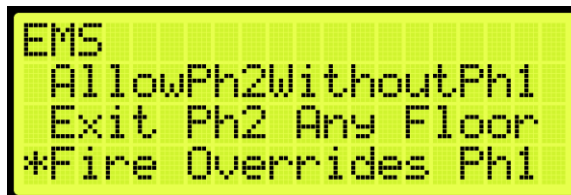

Figure 587: EMS Menu – Fire Overrides Ph1

3. From the FIRE OVERRIDES PH1 menu, scroll and select if a fire override Phase 1 EMS operation.



Figure 588: FIRE OVERRIDES PH1 Menu

4. Scroll right and press Save.

32.5.4 Ph1 Exit Delay

Phase 1 exit delay is the time a car remains in EMS Phase 1 (due to an emergency medical hall call) prior to returning to normal operation.

The following procedure describes how to set the time a car returns to normal operation from EMS Phase 1.

1. Navigate to MAIN MENU | SETUP | EMS (See Figure 61).
2. From the EMS menu, scroll and select Ph1 Exit Delay.

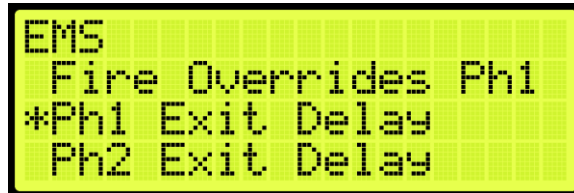

Figure 589: EMS Menu – Ph1 Exit Delay

3. From the PH1 EXIT DELAY menu, set the time the car remains at a landing prior to normal operation.



Figure 590: PH1 EXIT DELAY Menu

4. Scroll right and press Save.

32.5.5 Ph2 Exit Delay

Phase 2 exit delay is the time a car remains in EMS Phase 2 before exiting.

The following procedure describes how to set the EMS Phase 2 exit delay.

1. Navigate to MAIN MENU | SETUP | EMS (See Figure 61).
2. From the EMS menu, scroll and select Ph2 Exit Delay.

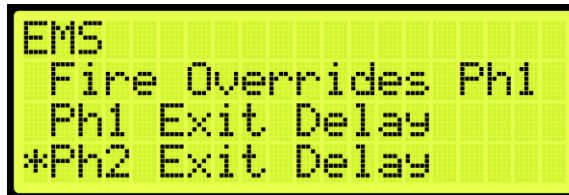

Figure 591: EMS Menu – Ph2 Exit Delay

3. From the PH2 EXIT DELAY menu, set the delay time prior to the doors closing.



Figure 592: PH2 EXIT DELAY Menu

4. Scroll right and press Save.

32.5.6 Ph1 Recall Floor

Ph1 Recall Floor is the floor the car recalls to when the MA EMS1 input is activated.

The following procedure describes how to set the Ph1 Recall Floor.

1. Navigate to MAIN MENU | SETUP | EMS (See Figure 61).
2. From the EMS menu, scroll and select Ph1 Recall Floor.



Figure 593: EMS Menu – Ph1 Recall Floor

3. From the PH1 RECALL FLOOR menu, set the recall floor.

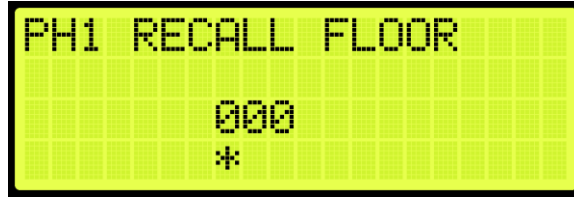

Figure 594: PH1 RECALL FLOOR Menu

4. Scroll right and press Save.

33 Load Weighing Device

The load weighing device monitors the weight of the car.

33.1 LWD Communication

Depending on the location of the LWD, the device communicates to the controller serially to the MR board or CT board.

The following procedure describes how to set the Load Weighing Device communication.

1. Navigate to MAIN MENU | SETUP | Load Weigher (See Figure 60).
2. From the LOAD WEIGHER SETUP menu, scroll and select Type Select.

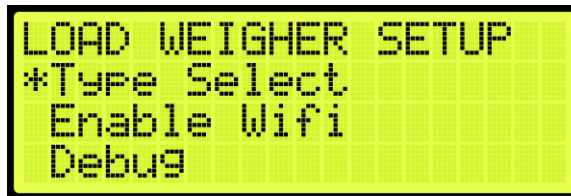

Figure 595: LOAD WEIGHER SETUP Menu – Type Select

3. Is the LWD connected to the MR or CT board?

NOTE: serial communication to the LWD will be disabled and system will look for discrete light/full/overload signals.



Figure 596: LOAD WEIGHER TYPE Menu – DISCRETE

- i. If the LWD is connected to the MR board, go to step 6.
 - ii. If the LWD is connected to the CT board, go to step 8.
4. From the LOAD WEIGHER TYPE menu, scroll and select SERIAL MR.

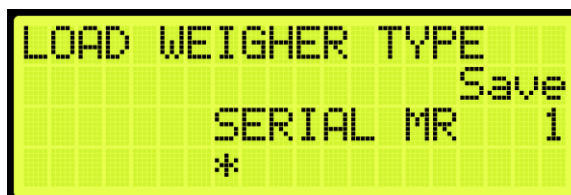

Figure 597: LOAD WEIGHER TYPE Menu – SERIAL MR

- 5. Scroll right and press Save. Process is complete.
- 6. From the LOAD WEIGHER TYPE menu, scroll and select Serial CT.



Figure 598: LOAD WEIGHER TYPE Menu – SERIAL CT

- 7. Scroll right and press Save.

34 Status

The status of each functionality can be viewed to determine which functions are active.

34.1 Input Status

The Input status displays the status for the configured inputs to the MR board.

The following procedure describes how to view the status of the inputs.

1. Navigate to MAIN MENU | STATUS | INPUTS (See Figure 45).
2. From the INPUTS BY FUNCTION menu, scroll and select the type of input.

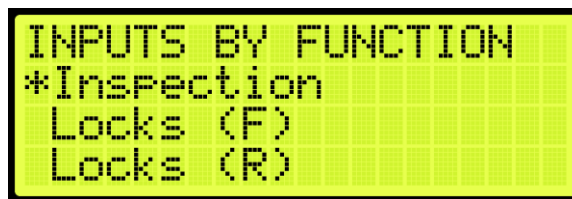

Figure 599: INPUTS BY FUNCTION Menu –Inspection

3. From the INSPECTION menu, view the status of the configured input.

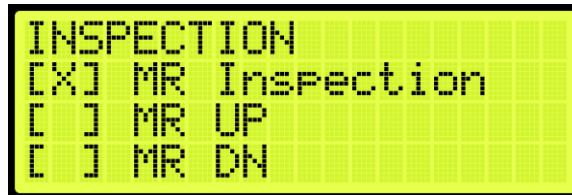

Figure 600: INSPECTION Menu

34.2 Output Status

The Output status displays the status for the configured outputs from the MR board.

The following procedure describes how to view the status of the outputs.

1. Navigate to MAIN MENU | STATUS | OUTPUTS (See Figure 45).
2. From the OUTPUTS BY FUNCTION menu, scroll and select the type of output.

```

OUTPUTS BY FUNCTION
Inspect/Access
*Controller
Safety

```

Figure 601: OUPUS BY FUNCTION Menu –Controller

- From the CONTROLLER menu, view the status of the configured output.

```

CONTROLLER
[ ] Light Fan
[ ] Battery Pwr
[ ] Safety Rescue

```

Figure 602: CONTROLLER Menu

34.3 Valves 1, 2, 3 & 4 Statures

The Valves 1, 2, 3 & 4 statuses display the activity of the valve and if there are any errors. The state and error displays 'UNKNOWN' when the valve is not connected in the controller. If a configuration error exists, an Invalid Config message is displayed.

The following procedure describes how to view the status of Valves 1, 2, 3 & 4.

- Navigate to MAIN MENU | STATUS | Valve 1 Status (See Figure 45) or Valve 2, 3, 4 (See Figure 46).
- From the Valve Status menu, view the status of the valve.

```

OFFLINE
ERROR: UNK
VERSION: 0
[ ][ ][ ] SM

```

Figure 603: Valve Status Menu – Part 1 of 3

```

[ ][ ][ ] SAFE & NTS
[ ][ ][ ] UH
[ ][ ][ ] UL
[ ][ ][ ] DH

```

Figure 604: Valve Status Menu – Part 2 of 3



Figure 605: Valve Status Menu – Part 3 of 3

The Valve Status menus display the following:

- **Valve Activity:** displays if the valve is online or offline.
- **Error:** displays an error code if a fault exists.
- **Version:** displays the version.
- **SM through DL:** displays the status of the Valve board – command from the controller, input to the Valve board and output from the Valve board.
- **DIP 1:** displays the status of the primary and secondary Valve boards (Command, Input and Output).
- **DIP 2:** displays the status of operation of the secondary Valve board. If DIP 2 is ON, the secondary Valve board testing will pause.

34.4 Soft Starter and Soft Starter 2 Status

The Soft Starter status' displays the status of the primary and secondary (if configured) soft starters.

The following procedure describes how to view the Soft Starter status.

1. Navigate to MAIN MENU | STATUS | SOFT STARTER STATUS or SOFT STARTER 2 STATUS (See Figure 47).
2. From the Soft Starter Status menus, view the status of the Soft Starter.

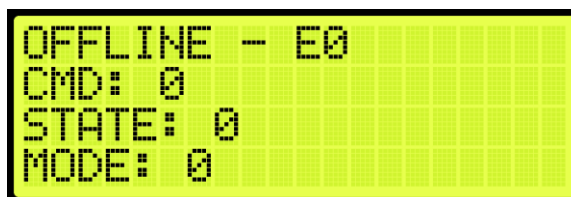

Figure 606: Soft Starter Status Menu – Part 1 of 3

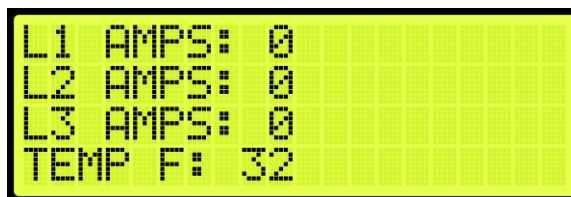

Figure 607: Soft Starter Status Menu – Part 2 of 3

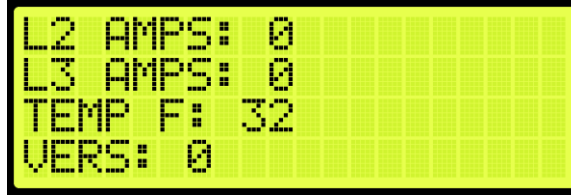

Figure 608: Soft Starter Status Menu – Part 3 of 3

The Soft Starter and Soft Starter 2 Status menus display the following:

- **Soft Starter Activity:** displays if the soft starter is online or offline.
- **CMD:** displays an error code if a fault exists.
- **STATE:** displays the state of the soft starter.
- **MODE:** displays the mode of the soft starter.
- **L1 through L3:** displays the amount of current through each phase to soft starter.
- **Temperature:** displays the temperature of the soft starter in °F.
- **Version:** displays current software version of the soft starter.

34.5 Expansion Status

The Expansion status displays the input/output of an expansion board in service. The “IN:” and “OUT:” display any active inputs or outputs on the board.

The following procedure describes how to view the expansion status.

1. Navigate to MAIN MENU | STATUS | EXPANSION STATUS (See Figure 47).
2. From the EXPANSION STATUS menu, scroll and select which expansion board group is being viewed.

NOTE: expansion boards are set in groups of 8. If a 24-input board is used, only the first expansion would show online.

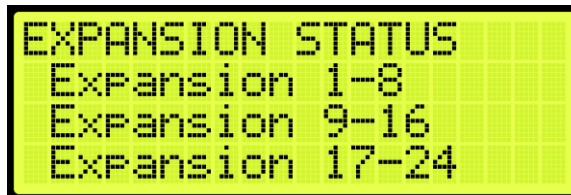

Figure 609: EXPANSION STATUS Menu – Expansion Group

4. From the EXPANSION Status menu, view the status of an Expansion board.



Figure 610: Active Expansion Board Status



Figure 611: Inactive Expansion Board Status

The Expansion Board Status menu displays the following:

- **Expansion Board Activity:** displays the connection status of the board.
- **In:** shows active inputs.
- **Out:** shows active outputs.
- **Error:** if a red LED is lit, the Expansion Board status shows an error.

34.6 Riser Board Status

The Riser board status displays the activity of the hall network and if there are any errors.

The following procedure describes how to view the Riser board status.

1. Navigate to MAIN MENU | STATUS | RISER BOARD STATUS (See Figure 48).
2. From the Riser board menu, view the Riser board status.

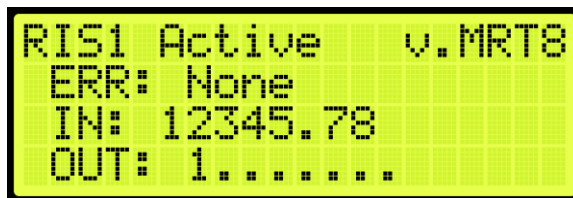

Figure 612: Active Riser Board Status



```
RIS1 InActive v.MRT8
ERR: Unknown
IN: .....
OUT: .....,
```

Figure 613: Inactive Riser Board Status

The Riser Board Status menu displays the following:

- **Riser Board Activity and Version:** displays the version software of the Riser board on the top right and the activity. If the Riser board is online, it shows active, but if the Riser board is offline, it shows inactive.
- **Error:** if a red LED is lit, the Riser Board status shows an error.
- **In:** shows active inputs.
- **Out:** shows active outputs.

34.7 CPLD

The CPLD status displays the current CPLD software version, faults, commands, and type of input during preflight operation.

The following procedure describes how to view the MR CPLD status.

1. Navigate to MAIN MENU | STATUS | CPLD STATUS (See Figure 51).
2. From the CPLD STATUS menu, scroll and select the (MR, CT, or COP) CPLD.

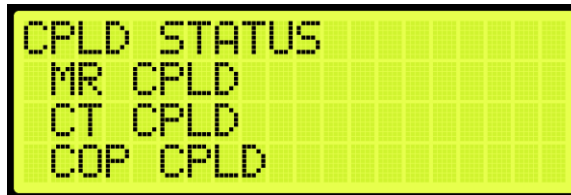

```
CPLD STATUS
MR CPLD
CT CPLD
COP CPLD
```

Figure 614: CPLD STATUS Menu – MR, CT, COP CPLD

3. From the CPLD menu, view the CPLD status.

NOTE: Scroll down to see additional information.

```
MR CPLD  
VERSION: MR 3.7  
FLT: 00 - NONE  
PF STAT: INACTIVE
```

Figure 615: MR CPLD Menu

```
PF CMD: INACTIVE  
PFE: 00  
INPUTS:  
RELAY C SFP [S][M]
```

Figure 616: MR CPLD Menu Continued

```
CT CPLD  
VERSION: CT 3.7  
FLT: 00 - NONE  
PF STAT: INACTIVE
```

Figure 617: CT CPLD Menu

```
PM CMD: INACTIVE  
PFE: 00  
INPUTS:  
CT SW [S][M]
```

Figure 618: CT CPLD Menu Continued

```
COP CPLD  
VERSION: COP 3.7  
FLT: 00 - NONE  
PF STAT: INACTIVE
```

Figure 619: COP CPLD Menu

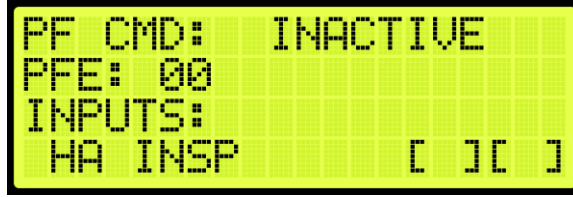

Figure 620: COP CPLD Menu Continued

The status as seen by the CPLD (safety processor) is marked by an “S” in the first bracket when the input is active. The status as seen by the MR, CT, or COP boards are marked by an “M” in the second bracket when the input is active.

S: Safety (CPLD)

M: MCU (MR/COP/CT)

The table below lists the CPLD menu description.

Table 52: CPLD Menu Description

CPLD Menu	Description
CPLD	Displays the type of CPLD being viewed.
VERSION	Displays the CPLD version software.
PFE	Displays the preflight failure number of the CPLD.
FLT	Displays a fault code for an existing fault. If there is no fault, the status is shown as None.
PF STAT	Displays a check performed at the end of runs where safety critical inputs are toggled to confirm hardware functionality. Check if it passed or failed.
PF CMD	Displays the EB relay commands to the MR board as part of the preflight process. This field is not used by the CT and COP boards.
INPUTS	Status of signals read by both the CPLD and the MR, CT, or COP board.

The table below lists CPLD Preflight status.

Table 53: CPLD Preflight Status

Number	Name	Description
0	INACTIVE	Preflight not in progress.
1	ACTIVE	Preflight check is in progress.
2	PASS	Preflight has completed and detected no errors.
3	FAIL	Preflight has completed and detected errors.

The table below lists CPLD Preflight command.

Table 54: CPLD Preflight Command

Number	Name	Description
0	INACTIVE	No commands issued the EB relays.
4	PICK BYP	CPLD issuing override command to pick the EB4 relay.
5	DROP RG	CPLD issuing override command to drop the EB2 relay.
6	PICK RG	CPLD issuing override command to pick the EB2 relay.
7	DROP BYP	CPLD issuing override command to drop the EB4 relay.

The table below lists CPLD inputs.

Table 55: CPLD Inputs

Name	Description
MR Board	
RELAY C SFP	Control signal to the SFP relay
RELAY M SFP	Status signal of the SFP relay
RELAY C SFM	Control signal to the SFM relay
RELAY M SFM	Status signal of the SFM relay
RELAY C EB1	Control signal of the EB1 relay
RELAY M EB1	Status signal of the EB1 relay
RELAY C EB2	Control signal of the EB2 relay
RELAY M EB2	Status signal of the EB2 relay
RELAY C EB3	Control signal of the EB3 relay
RELAY M EB3	Status signal of the EB3 relay
RELAY C EB4	Control signal of the EB4 relay
RELAY M EB4	Status signal of the EB4 relay
PIT INSP	Status of the Pit Inspection input
LND INSP	Status of the Landing Inspection input
MR INSP	Status of the MR Inspection input
ATU	Status of the Access Top Up input
ATD	Status of the Access Top Down input
ABU	Status of the Access Bottom Up input
ABD	Status of the Access Bottom Down input
MM	Status of the Mechanics Mode input
BYP H	Status of the Bypass Hoistway Door switch
BYP C	Status of the Bypass Car Door switch
LRT	Status of the Rear Top Lock input
LRM	Status of the Rear Middle Lock input
LRB	Status of the Rear Bottom Lock input
LFT	Status of the Front Top Lock input
LFM	Status of the Front Middle Lock input

Name	Description
LFB	Status of the Front Bottom Lock input
120VAC	Status of the 120 VAC Source input
GOV	Status of the Governor input
PIT	Status of the Pit input
BUF	Status of the Buffer input
TFL	Status of the Top Final Limit input
BFL	Status of the Bottom Final Limit input
SFH	Status of the SFH Safety input
SFM	Status of the SFM Safety input
DIP 1B-8B	Status of DIP 1-8 switches
NTS	Status of the MR board NTS output
CT Board	
CT SW	Status of the CT switch
ESC HATCH	Status of the CT Escape Hatch input
CAR SAFE	Status of the CT Car Safeties input
CT INSP	Status of the CT Inspection input
GSWF	Status of the Front Gate switch input
GSWR	Status of the Rear Gate switch input
DZF	Status of the Front Door Zone input
DZR	Status of the Rear Door Zone input
DIP 1B-8B	Status of DIP 1-8 switches
COP Board	
HA INSP	Status of the Hoistway Access Inspection input
IC ST	Status of the IC Stop switch input
FSS	Status of the Fire stop switch input
IC INSP	Status of the IC Inspection input
DIP 1B-8B	Status of DIP 1-8 switches

34.8 E-Power Status

The E-Power status displays if the car is running off emergency power.

The following procedure describes how to view which car is on emergency power. If the command is off, then the car is not running on emergency power.

1. Navigate to MAIN MENU | STATUS | E-POWER STATUS (See Figure 51).
2. From the E-POWER COMMAND menu, view the cars running on emergency power.



Figure 621: E-POWER COMMAND Menu

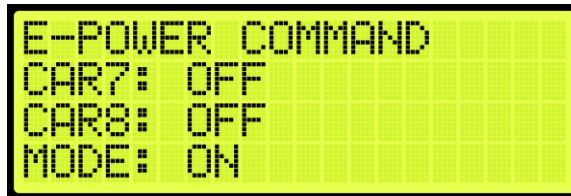

Figure 622: E-POWER COMMAND Menu Continued

The E-Power Command menu displays the status for each car within the group and the mode of operation.

The following is a list of Car Commands (Status) within the E-POWER COMMAND Menu.

- **Off:** emergency power is not active.
- **Precall:** command is issued briefly to check the car's underlying mode of operation. It should prevent the car from moving. This command is issued to allow the car to report its mode during E-Power OOS operations.
- **Recall:** the car is being commanded to go to its recall floor and remain there with doors open.
- **Auto:** the car is being commanded to run normally, for example, the car is selected to run.
- **OOS:** the car is commanded to emergency stop if in motion and remains faulted where it is until further commands are issued. This command is issued when a car is awaiting recall or has failed to recall. It is also issued if the up to speed input is missing.
- **Pretransfer:** the car is commanded to ramp down to the nearest landing if in motion and remains there with doors open until further commands are issued. This is issued when the pretransfer input is active.

The following is a list of Group State (mode) within the E-POWER COMMAND Menu. This section of the menu can be viewed when scrolling down.

- **Off:** the car group is not on emergency power.
- **On:** group cars are being held out of service, awaiting the signals necessary to begin recall.
- **Recall:** group cars are being recalled.
- **Run Car:** group cars are being selected to run.
- **Pretransfer:** group is in a pretransfer state due to the pretransfer input being active. Typically used to stop cars prior to transferring from generator power back to main line power.

34.9 EMS Status

The Emergency Medical Services (EMS) status displays the status of communication on a hall board when a car is set for EMS.

The following procedure describes how to view the EMS status.

1. Navigate to MAIN MENU | STATUS | EMS STATUS (See Figure 52).
2. From the EMS STATUS menu, scroll and view the status of the EMS hall calls assigned to the cars. An EMS hall call is assigned to the nearest car configured to take these calls.

NOTE: if a car is not assigned as EMS, the communication status displays NONE.



Figure 623: EMS STATUS Menu – Car 1 Assigned

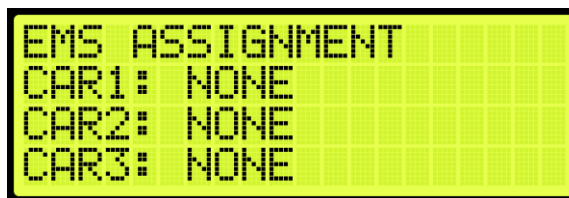

Figure 624: EMS STATUS Menu – No Cars Assigned

34.10 Hall Call Status

The Hall Call status displays the direction of the car when a hall call is placed.

The following procedure describes how to view all up or down calls.

1. Navigate to MAIN MENU | STATUS | HALL CALL STATUS (See Figure 50).
2. From the HALL CALL STATUS menu, scroll and select Up or Down Calls.

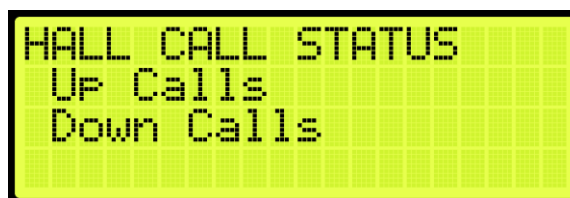

Figure 625: HALL CALL STATUS Menu –Up or Down Calls

3. From the UP CALLS or DOWN CALLS menu, scroll and view hall calls with the car moving up or down.



Figure 626:UP CALLS Menu

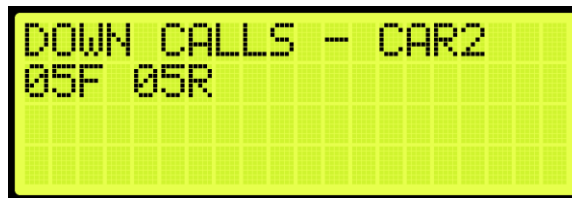

Figure 627: DOWN CALLS Menu

34.11 Virtual Inputs

Virtual inputs display the status of inputs virtually instead of the main screens on the MR, CT, or COP boards.

34.11.1 Remote Commands

The remote commands are the commands and have parameters that have been sent remotely to the controller. The remote commands display the status of commands that would be sent by remote access.

34.11.1.1 Car Call Security

The car call security displays the hall security mask set via remote monitoring. Each bit represents a set of four floors. For example, if floors 1 and 4 are set for security access, then the display shows 00000009. If just floor 1 was set for security access, then the display shows 00000001. If no floors are set for security access, then the display shows 00000000.

The following procedure describes how to view the car call security status for front or rear doors.

1. Navigate to MAIN MENU | STATUS | VIRTUAL INPUTS (See Figure 52).
2. From the REMOTE COMMANDS menu, scroll and select Car Call Security.



Figure 628: REMOTE COMMANDS Menu – Car Call Security

- From the SECURE CAR CALLS menu, select either the front or rear car calls.



Figure 629: SECURE CAR CALLS Menu – Front or Rear

- From the Secure Car menu, view the status of front or rear car doors that require security access.

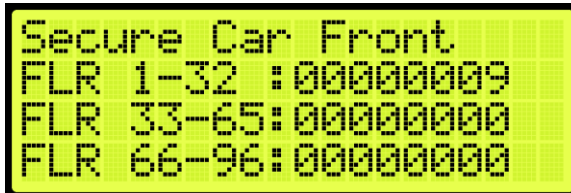

Figure 630: Secure Car Front Menu



Figure 631: Secure Car Rear Menu

34.11.1.2 Hall Call Security

The hall call security displays the status of the hall call security mask set on the remote monitoring system. Each bit represents a set of four floors. For example, if floors 1 and 4 are set for security access, then the display shows 00000009. If just floor 1 was set for security access, then the display shows 00000001. If no floors are set for security access, then the display shows 00000000.

The following procedure describes how to view the hall call security status for front or rear doors.

- Navigate to MAIN MENU | STATUS | VIRTUAL INPUTS (See Figure 52).
- From the REMOTE COMMANDS menu, scroll and select Hall Call Security.



Figure 632: REMOTE COMMANDS Menu – Hall Call Security

- From the SECURE HALL CALLS menu, select either the front or rear hall calls.



Figure 633: SECURE HALL CALLS Menu – Front or Rear

- From the Secure (Front or Rear) Hall Call menu, view the status of front or rear car doors that require security access.

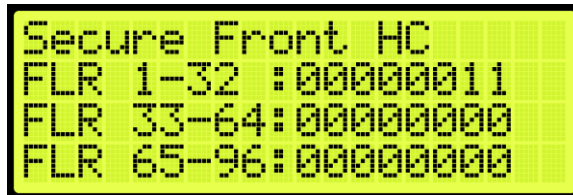

Figure 634: Secure Front Hall Call Menu

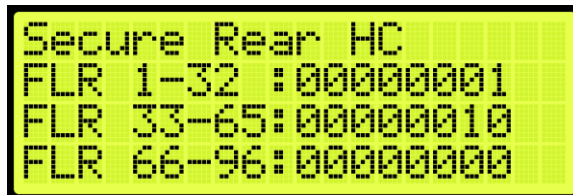

Figure 635: Secure Rear Hall Call Menu

34.11.1.3 Dynamic Security

Dynamic Security enables the Car Call Security and Hall Call Security features for a user-defined period of time (date-specific and time-specific).

This feature is available via the GUI and Local Monitoring Apps.

NOTE I: under Dynamic Security, the user cannot define which floors will have Car Call Security and/or Hall Call Security – once one of the front doors requires either security, ALL the front doors will be secured, and once one of the rear doors requires either security type, ALL the rear doors will be secured.

NOTE II: under Dynamic Security, in case of group operation, the user can specify to enable the Car Call Security on certain cars. However, this is not the same for the Hall Call Security feature – the Hall Call Security, when enabled, will be automatically applied on all cars.

34.11.1.4 Virtual Input

The recall input displays the status of inputs set through the remote monitoring system.

The following procedure describes how to view the status of the auto operation input.

1. Navigate to MAIN MENU | STATUS | VIRTUAL INPUTS (See Figure 52).
2. From the REMOTE COMMANDS menu, scroll and select Virtual Inputs.



Figure 636: REMOTE COMMANDS Menu – Virtual Inputs

3. From the Virtual Input menu, view the status of auto operation inputs that are active.

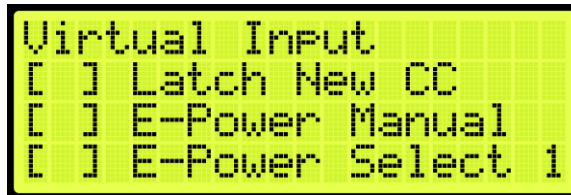

Figure 637: Virtual Input Menu

34.11.1.5 Recall Input

The recall input displays the status of which floor a car is recalled to and whether the front or rear door opens when recalled through the remote monitoring system.

The following procedure describes how to view the status of the recall floor and door that opens during an emergency.

1. Navigate to MAIN MENU | STATUS | VIRTUAL INPUTS (See Figure 52).
2. From the REMOTE COMMANDS menu, scroll and select Recall Input.



```
REMOTE COMMANDS
Virtual Inputs
*Recall Input
Door Command Landin
```

Figure 638: REMOTE COMMANDS Menu – Recall Input

3. From the Recall Floor/Door menu, view the floor the car is recalled, and which door opens.

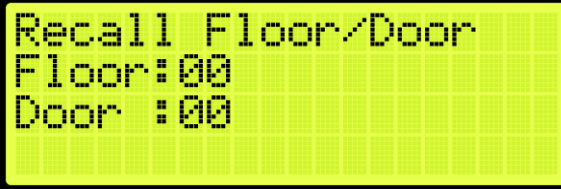

```
Recall Floor/Door
Floor:00
Door :00
```

Figure 639: Recall Floor/Door Menu

34.11.1.6 Door Command Landing

The door command landing displays the status of the doors that have been set to land at a designated floor.

The following procedure describes how to view the status of a door set to land at a designated floor.

1. Navigate to MAIN MENU | STATUS | VIRTUAL INPUTS (See Figure 52).
2. From the REMOTE COMMANDS menu, scroll and select Door Command Landing.



```
REMOTE COMMANDS
Virtual Inputs
Recall Input
*Door Command Landin
```

Figure 640: REMOTE COMMANDS Menu – Door Command Landing

3. From the Door Command Landing menu, view the designated landing of the car.



```
Door Command Landing
Floor:000
```

Figure 641: Door Command Landing Menu

34.12 DIP Status

The DIP status displays the DIP switches on the MR, CT, or COP board that are ON. The following procedure describes how to view which DIP switches are ON.

1. Navigate to MAIN MENU | STATUS | DIP STATUS (See Figure 52).
2. From the DIP STATUS menu, select MR, CT, or COP DIP.

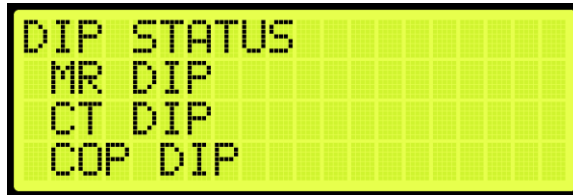

Figure 642: DIP STATUS Menu – MR, CT, or COP DIP

3. From the DIP SWITCHES menu, view the DIP switches that are on for the MR, CT, or COP board.



Figure 643: DIP SWITCHES Menu

34.13 Door Status

The door status displays the input status of a front or rear door.

The following procedure describes how to view the status of the doors.

1. Navigate to MAIN MENU | STATUS | DOOR STATUS (Front or Rear) (See Figure 53).
2. From the Door Status menu, view the input status of the door.

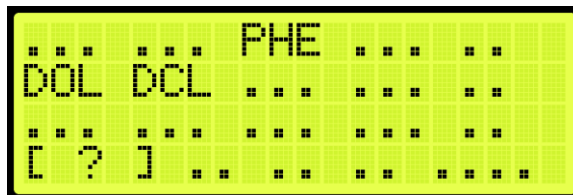

Figure 644: Door Status Menu

35 Group Setup

Group setup are the rules for a set of cars within the group. Each group can consist of a maximum of eight cars.

35.1 Group Car Index

The group car index is the car ID in the group.

The following procedure describes how to set the group car index.

1. Navigate to MAIN MENU | SETUP | GROUP SETUP (See Figure 61).
2. From the GROUP SETUP menu, scroll and select Group Car Index.



Figure 645: GROUP SETUP Menu – Group Car Index

3. From the GROUP CAR INDEX menu, enter the car ID.

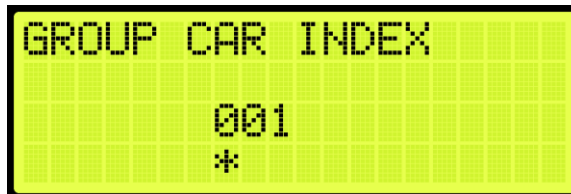

Figure 646: GROUP CAR INDEX Menu

4. Scroll right and press Save.

35.2 Group Landing Offset

The group landing offset sets the number of floors below the car's lowest served floor that are serviced by other groups. This allows calls between different cars to be aligned so they refer to the same landing and is vital to proper dispatching.

The following procedure describes how to set the group landing offset.

1. Navigate to MAIN MENU | SETUP | GROUP SETUP (See Figure 61).
2. From the GROUP SETUP menu, scroll and select Group Landing Offset.



Figure 647: GROUP SETUP Menu – Group Landing Offset

3. From the GROUP LANDING OFFSET menu, set the number of floors below a group that are serviced by another group.



Figure 648: GROUP LANDING OFFSET Menu

4. Scroll right and press Save.

35.3 Dispatch Timeout

The dispatch timeout is a set time a car has to answer a hall call. If time has elapsed, the car is taken out of group and the call is reassigned to another car.

The following procedure describes how to set the dispatch timeout.

1. Navigate to MAIN MENU | SETUP | GROUP SETUP (See Figure 61).
2. From the GROUP SETUP menu, scroll and select Dispatch Timeout.

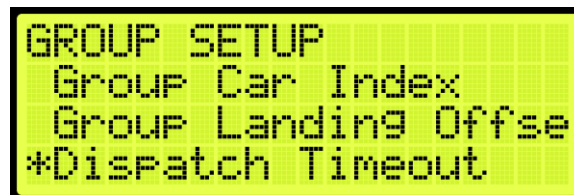

Figure 649: GROUP SETUP Menu – Dispatch Timeout

3. From the DISPATCHING TIMEOUT menu, set the time the car has to answer a car call prior to another car responding. A setting of 0 disables this feature.

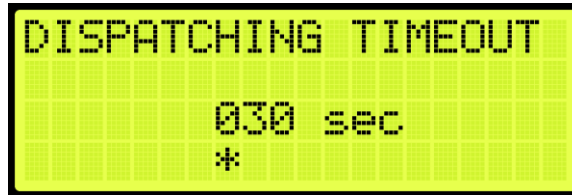

Figure 650: DISPATCHING TIMEOUT Menu

4. Scroll right and press Save.

35.4 Dispatch Offline Timeout

The dispatch offline timeout sets the time a car is out of the group due to not responding to a hall call.

The following procedure describes how to set the dispatch offline timeout.

1. Navigate to MAIN MENU | SETUP | GROUP SETUP (See Figure 61).
2. From the GROUP SETUP menu, scroll and select Dispatch Offline Timeout.



Figure 651: GROUP SETUP Menu – Dispatch Offline Timeout

3. From the DISPATCHING OFFLINE menu, set the time the car is out of the group. If set to zero, this feature is disabled.

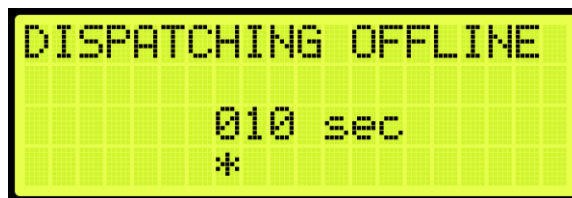

Figure 652: DISPATCHING OFFLINE Menu

4. Scroll right and press Save.

36 XREG

Cross registration allows for the controller dispatching system to interface with non-Smartrise controllers.

36.1 XReg Cars

Cross registration cars set the number of cars from the legacy system to be included for dispatching.

The following procedure describes how to set XREG cars.

1. Navigate to MAIN MENU | SETUP | GROUP SETUP (See Figure 61).
2. From the GROUP SETUP menu, scroll and select XReg Cars.



Figure 653: GROUP SETUP Menu – XREG Cars

3. From the NUM XREG CARS menu, enter the number of cars from the legacy system.



Figure 654: NUM XREG CARS Menu

4. Scroll right and press Save.

36.2 XReg Dest Timeout

If a car has been assigned a cross registration destination and does not answer within in a specific period, the car is taken out of the group until the cross-registration timeout has elapsed.

The following procedure describes how to set the cross-registration timeout.

1. Navigate to MAIN MENU | SETUP | GROUP SETUP (See Figure 61).
2. From the GROUP SETUP menu, scroll and select XReg Destination Timeout.



```
GROUP SETUP
Dispatch Offline Ti
XReg Cars
*XReg Dest Timeout
```

Figure 655: GROUP SETUP Menu – XReg Destination Timeout

3. From the XREG DESTINATION TIMEOUT menu, set the time for a cross registration car to answer a car call prior to another car responding. If set to zero, this feature is disabled.

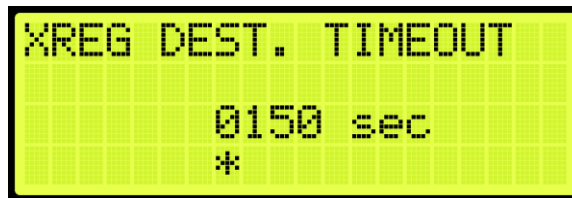

```
XREG DEST. TIMEOUT
0150 sec
*
```

Figure 656: XREG DESTINATION TIMEOUT Menu

4. Scroll right and press Save.

36.3 XReg Dest Offline Timeout

The cross registration offline timeout is the time a car is out of the group due to not answering hall calls.

The following procedure describes cross registration destination offline timeout.

1. Navigate to MAIN MENU | SETUP | GROUP SETUP (See Figure 61).
2. From the GROUP SETUP menu, scroll and select XReg Destination Offline Timeout.



```
GROUP SETUP
XReg Dest Timeout
*XReg Dest Offline T
Enable Hall Securit
```

Figure 657: GROUP SETUP Menu – XReg Destination Offline Timeout

- From the XREG DESTINATION OFFLINE TIMEOUT menu, set the time a cross registration car is out of the group. If set to zero, this feature is disabled.



Figure 658: XREG DESTINATION OFFLINE TIMEOUT Menu

- Scroll right and press Save.

36.4 XReg Destination

The destination for each car call and hall call within the group is monitored in the system. The display shows the type of call and whether it's for a front or rear opening. If a hall call is placed, then the mask will reflect the mask for the hall call being answered. To view the destination of each individual car within the group, press the up or down button.

The following procedure describes how to view the car call destination.

- Navigate to MAIN MENU | DEBUG | XREG DESTINATION (See Figure 69).
- From the DESTINATION menu, view the destination of the car within the group.



Figure 659: DESTINATION Menu

36.5 XReg Data

Cross registration data displays additional information about the status of each Alien Car.

The following procedure describes how to view the status of the car.

- Navigate to MAIN MENU | DEBUG | XREG DATA (See Figure 69).
- From the Car Data Overview Status (See Figure 263), press the right button.
- From the Hall Mask Status (See Figure 264), press the right button.
- From the Front Opening Map Status (See Figure 265), view the status and press the right button.
- From the Rear Opening Map Status (See Figure 266), view the status and press the right button.

- 6. From the Emergency Power Status, view the status and press the right button.

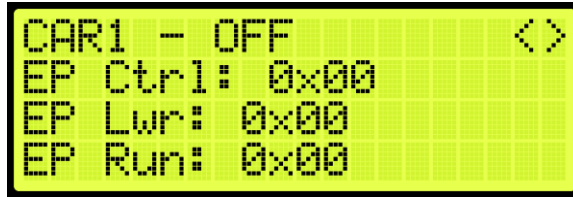

Figure 660: Emergency Power Status Menu

- 7. From the Fire Emergency Power Status, view the status.

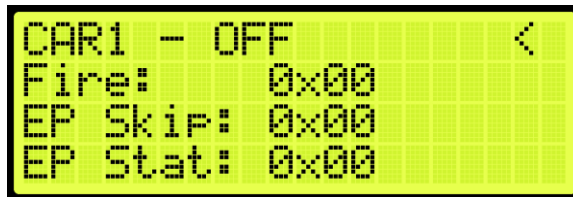

Figure 661: Fire Emergency Power Status Menu

37 PI Labels

The Position Indicator (PI) label allows the user to label any landing with a 2-digit alpha-numeric identifier. To allow for 3-digit alpha-numeric identifiers, see Section 28.11 En. 3 Digit PI.

The following procedure describes how to set the position indicator labels.

1. Navigate to MAIN MENU | SETUP | PI LABELS (See Figure 59).
2. From the SET PI LABEL menu, scroll and select the floor indicator label.



Figure 662: SET PI LABEL Menu

3. Scroll right and press Save.

38 Attendant

Attendant operation is an automatic mode of operation in which an attendant manually operates the car. The attendant has an up and down lamp in the car indicating if there are hall calls latched above or below the car's current floor. The attendant uses these lamps, as well as UP and DOWN direction buttons, which control the next direction of the car, to pick up passengers and drop them off at their desired location. When stopped at a landing, the car doors will manually open at a floor and must be manually closed by the attendant via the door close button.

38.1 Dispatch Timeout

Each car is set to answer hall call for a set time. If a car in the group does not answer a hall call, the call is reassigned to another car.

The following procedure describes how to set the dispatch timeout.

1. Navigate to MAIN MENU | SETUP | ATTENDANT (See Figure 62).
2. From the ATTENDANT menu, scroll and select Dispatch Timeout.



Figure 663: ATTENDANT Menu – Dispatch Timeout

3. From the DISPATCH TIMEOUT menu, set the time for another car to take over the hall call.



Figure 664: DISPATCH TIMEOUT Menu

4. Scroll right and press Save.

38.2 Buzzer Time

A buzzer may sound for a period of time after a hall call is placed.

The following procedure describes how to set the time a buzzer rings after a hall call is placed.

1. Navigate to MAIN MENU | SETUP | ATTENDANT (See Figure 62).

- From the ATTENDANT menu, scroll and select Buzzer Time.



Figure 665: ATTENDANT Menu – Buzzer Time

- From the BUZZER TIME menu, set the time the buzzer rings for after a hall call has been requested.

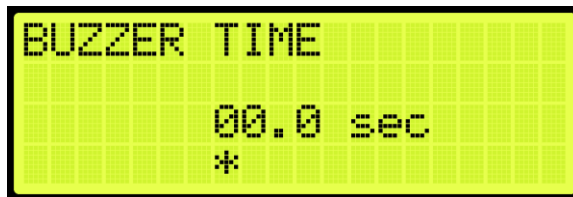

Figure 666: BUZZER TIME Menu

- Scroll right and press Save.

39 Real-Time Clock

The real-time clock keeps track of the current time and date. Only the MASTER car has the option to change the Real-Time Clock. All other cars will say go to master to set time.

The following procedure describes how to set real-time.

1. Navigate to MAIN MENU | SETUP | REAL-TIME CLOCK (See Figure 60).
2. From the Real-Time Clock menu, set the date and time.

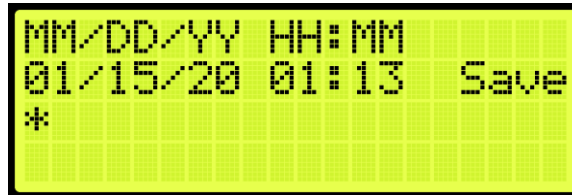

Figure 667: Real-Time Clock Menu

3. Scroll right and press Save.

39.1 Clock Status

The clock status displays real-time and date.

The following procedure describes how to view the real-time and date.

1. Navigate to MAIN MENU | STATUS | CLOCK (See Figure 50).
2. From the Clock menu, view real-time and date.

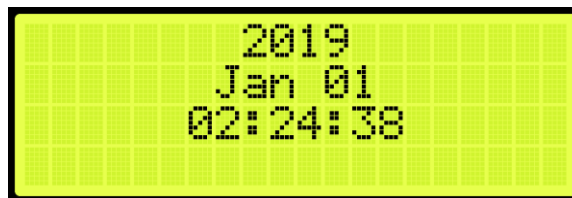

Figure 668: Clock Menu

40 Debug

The Debug menu allows for viewing various statuses.

40.1 View Debug

The View Debug Data menu can be used to view important debugging information passed from the main system processors MR, CT and COP boards and can be navigated to view from each board’s UI.

The View Debug Data menu (see Figure 669) displays the number of bus errors detected since startup. It also displays a rough estimate of the percentage of bus throughput currently in use. This data can be used to diagnose communication issues caused by transmission problems and excessive bus traffic.

The following procedure describes how to view the debug data.

1. Navigate to MAIN MENU | DEBUG | VIEW DEBUG DATA (See Figure 66).
2. From the View Debug Data menu, scroll and select the Debug Data of the system to be viewed.

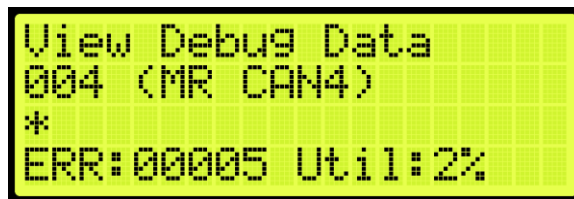

Figure 669: View Debug Data Menu

The table below lists the data index for MR, CT, and COP board communication.

Table 56: Data Index for MR, CT, and COP Board Communication

Data Index	Name	Description
1	MR CAN 1	MR board CAN1, Car Network (CN1+/-).
2	MR CAN 2	MR board CAN2, Brake Network (BN+/-).
3	MR CAN 3	MR board CAN3, Aux Network (AN+/-).
4	MR CAN 4	MR board CAN 4, Group Network (GN+/-).
5	MR A NET	MR board A processor RS232 Network. Shows errors in packets received by the A processor, sent by the B processor.
6	MR B NET	MR board B processor RS232 Network. Shows errors in packets received by the B processor, sent by the A processor.
7	MR RS485	MR board RS485 Drive network (RX+/-).
8	CT CAN 1	CT board CAN1, Car Network (CN1+/-).
9	CT CAN 2	CT board CAN2, CEDES camera channel 2.
10	CT CAN 3	CT board CAN3, Aux Network (C3H/L).

Data Index	Name	Description
11	CT CAN 4	CT board CAN4, CEDES camera channel 1.
12	CT A NET	CT board A processor RS232 Network. Shows errors in packets received by the A processor, sent by the B processor.
13	CT B NET	CT board B processor RS232 Network. Shows errors in packets received by the B processor, sent by the A processor.
14	CT RS485	CT board RS485 network.
15	COP CAN 1	COP board CAN1, Car Network (CN1+/-).
16	COP CAN 2	COP board CAN2, CEDES camera #2 channel 2.
17	COP CAN 3	COP board CAN3, Aux Network (C3H/L).
18	COP CAN 4	COP board CAN4, CEDES camera #2 channel 1.
19	COP A NET	COP board A processor RS232 Network. Shows errors in packets received by the A processor, sent by the B processor.
20	COP B NET	COP board B processor RS232 Network. Shows errors in packets received by the B processor, sent by the A processor.
21	COP RS485	COP board RS485 Network.
22	Run Signal	Displays car run signals as a string of binary digits. From right to left, functions are mapped to this list, from top to bottom: <ol style="list-style-type: none"> 1. Destination Chosen, Run Requested 2. Car Doors Closed 3. Hall Locks Closed 4. Motion Run Flag ON 5. DSD Drive HW Enable 6. Pick M Contactor 7. M Contactor Feedback 8. Drive Energize Commanded 9. Pick B Contactor 10. Serial Speed Reg Rls 11. Brake Pick Command 12. BPS (Software) 13. E-Brake Pick Command 14. E-BPS (Software) 15. Command Speed Nonzero 16. Camera Speed Nonzero
23	Last Stop Pos	Displays the position the car stopped at last run. Only records for normal run stops at the start of the brake drop stop sequence state.
24	MRA Vers.	Displays the third segment of the processor A software version number on the MR board up to 4 characters.

Data Index	Name	Description
25	MRB Vers.	Displays the third segment of the processor B software version number on the MR board up to 4 characters.
26	CTA Vers.	Displays the third segment of the processor A software version number on the CT board up to 4 characters.
27	CTB Vers.	Displays the third segment of the processor B software version number on the CT board up to 4 characters.
28	COPA Vers.	Displays the third segment of the processor A software version number on the COP board. Up to 4 characters.
29	COPB Vers.	Displays the third segment of the processor B software version number on the COP board. Up to 4 characters.
30	Dir. Change Count	Displays the number of times the car has changed direction of movement since controller startup. To reset this count, trigger a FRAM default via SETUP MISCELLANEOUS DEFAULT DEFAULT FRAM, turn to ON (See Section 28.16.7 Default FRAM).
31	RIS1 CAN1	Displays the error count seen on Riser 1's CAN1 network.
32	RIS2 CAN1	Displays the error count seen on Riser 2's CAN1 network.
33	RIS3 CAN1	Displays the error count seen on Riser 3's CAN1 network.
34	RIS4 CAN1	Displays the error count seen on Riser 4's CAN1 network.
35	RIS1 CAN2	Displays the error count seen on Riser 1's CAN2 network.
36	RIS2 CAN2	Displays the error count seen on Riser 2's CAN2 network.
37	RIS3 CAN2	Displays the error count seen on Riser 3's CAN2 network.
38	RIS4 CAN2	Displays the error count seen on Riser 4's CAN2 network.
39	DEST CURRENT	Displays information on the current and next destination in the currently serviced direction as seen by MRA.
40	DEST NEXT	Displays information on the next proposed destination in the direction opposite the currently serviced direction as seen by MRA in addition to destination door zone.
41	IDLE TIME	Displays the different idle timers used by the system.
42	DRV SPD	Displays the drive's reported speed (DRV), the commanded speed (CMD), and the camera speed (SPD).
43	DOOR DATA F	Displays front door state machine and timer data.
44	DOOR DATA R	Displays rear door state machine and timer data.
45	N/A	Reserved for viewing data via the STATUS CPLD STATUS screen.
46	N/A	Reserved for viewing data via the STATUS CPLD STATUS screen.
47	N/A	Reserved for viewing data via the STATUS CPLD STATUS screen.

40.2 Enter Car Calls

Enter Car Calls allows the user to enter a car call from the MR, CT, or COP board. The front door or rear door opens, if available, to the selected door and floor. Entering car calls from here will bypass all forms of security.

NOTE: the rear car calls display when there are latched rear doors.

The following procedure describes how to set up a car call.

1. Navigate to MAIN MENU | DEBUG | ENTER CAR CALLS (See Figure 64).
2. From the ENTER CAR CALLS menu, scroll and select Front or Rear.



Figure 670: ENTER CAR CALLS Menu – Front or Rear

3. From THE ENTER CAR CALL menu, scroll to view the latched car calls.



Figure 671: ENTER CAR CALL Menu

40.3 Enter Hall Calls

Enter Hall Call allows the user to enter Hall Calls to the group from the MR board.

The following procedure describes how to enter hall calls.

1. Navigate to MAIN MENU | DEBUG | ENTER HALL CALLS (See Figure 64).
2. From the HALL CALL menu, enter hall call.



Figure 672: Hall Call Menu

The Hall Call Mask menu allows:

- **Landing:** the user to select the landing (this is not based on PI Labels, but landing-based, as in 1 is the first floor, 2 is the second floor, etc).
- **Dir:** the controller to know which direction the request is made for (DN for Down, UP for Up).
- **Mask Value:** the mask of the function the user wants. For example, by default, all jobs use a mask value of 1 for front hall calls. The user will change the mask value to 1 to initiate a front hall call. When these three are set (Land, Dir, Mask), the user must press the middle/enter button to send the information.
- **Latched:** shows what mask value has been accepted into the dispatching.

40.4 Enter Door Command

The Enter Door Command allows the user to assert a Door Open, Door Close, or Nudge commands from any of the MR, CT, or COP boards if the car is idle, unfaulted, and safe.

1. Navigate to MAIN MENU | DEBUG | ENTER DOOR COMMAND (See Figure 64).
2. From the Enter Door Command menu, the user can assert a command to either close, open, or nudge a door.

NOTE: the display shows an option for front and rear doors when configured for rear doors. If there are only front doors, then the display does not show an option for the type of door.



Figure 673: Enter Door Command Menu (Front and Rear Doors)



Figure 674: Enter Door Command Menu (Front Doors Only)

40.5 View Network Packet

The view network packet allows the user to view the raw data and receive counts of packets sent between the MR, CT, and COP boards.

The following procedure describes how to view the network packet.

1. Navigate to MAIN MENU | DEBUG | VIEW NETWORK PACKET (See Figure 65).
2. View the Network Packet.

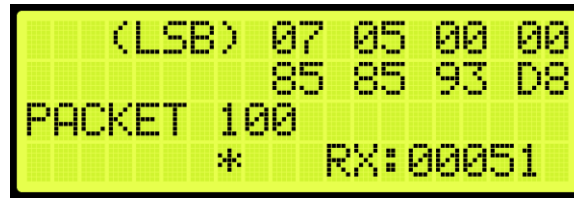

Figure 675: Network Packet

40.6 View Group Packet

The view group packet page allows the user to view the raw data and receive counts of packets sent between group cars via the GN ± network.

The following procedure describes how to view group packets.

1. Navigate to MAIN MENU | DEBUG | VIEW GROUP PACKET (See Figure 65).
2. View the Group Packet.

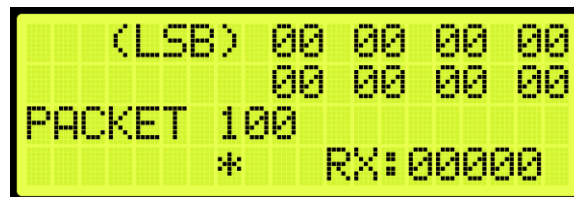

Figure 676: Group Packet

40.7 Acceptance Test

The acceptance test allows for verification testing. See *Hydro:Evolved Testing Procedure* for more information.

The following procedure describes how to view the selected acceptance test.

1. Navigate to MAIN MENU | DEBUG | ACCEPTANCE TEST (See Figure 66).
2. View the SELECT ACCEPTANCE TEST menu.

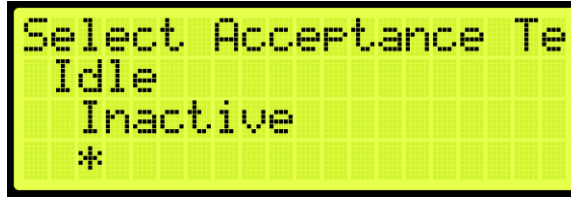

Figure 677: SELECT ACCEPTANCE TEST Menu

40.8 Emergency Bitmap

The emergency bitmap displays the type of emergency.

The following procedure describes how to view emergencies.

1. Navigate to MAIN MENU | DEBUG | EmergencyBitmap (See Figure 66).
2. From the EMERGENCY STATUS menu, view the type of emergency that has an X by the name.



Figure 678: EMERGENCY STATUS Menu

40.9 Module Statuses

The module status displays the current status of various functions.

40.9.1 Motion Status

The motion status displays the current motion of the car, the start and stop condition, and the type of profile.

The following procedure describes how to view the status of the motion for the car.

1. Navigate to MAIN MENU | DEBUG | Module Statuses (See Figure 67).
2. From the MODULE STATUS menu, scroll and select Motion Status.

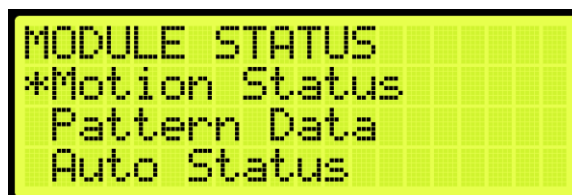

Figure 679: MODULE STATUS Menu – Motion Status

3. From the Motion Status menu, scroll and view the Motion Status information.



Figure 680: Motion Status Menu Part 1 of 2

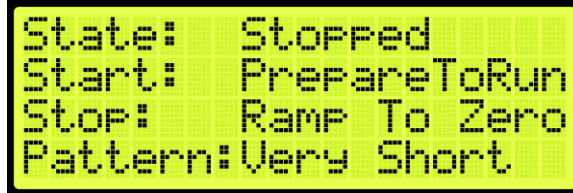

Figure 681: Motion Status Menu Part 1 of 2

40.9.2 Pattern Data

The pattern data is the information used to determine traffic.

The following procedure describes how to view the pattern data for the car.

1. Navigate to MAIN MENU | DEBUG | Module Statuses (See Figure 67).
2. From the MODULE STATUS menu, scroll and select Pattern Data.

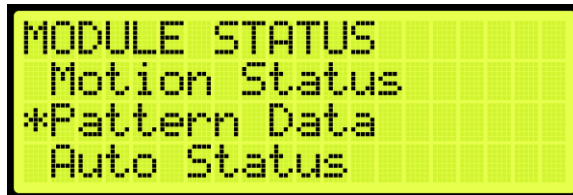

Figure 682: Module Status Menu – Pattern Data

3. From the PATTERN DATA menu, view the Pattern Data.

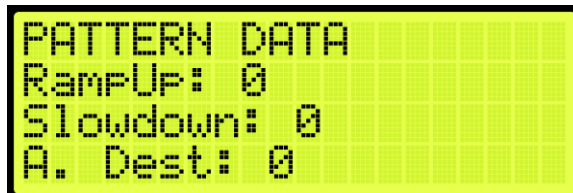

Figure 683: PATTERN DATA Menu Part 1 of 2

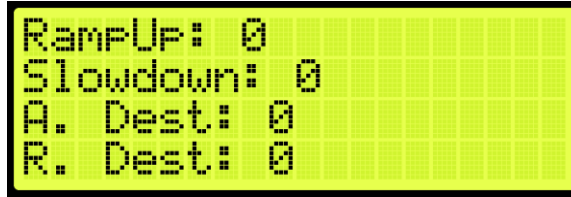

Figure 684: PATTERN DATA Menu Part 2 of 2

40.9.3 Auto Status

The auto status displays the status of automatic operation.

The following procedure describes how to view the automatic status.

1. Navigate to MAIN MENU | DEBUG | Module Statuses (See Figure 67).
2. From the MODULE STATUS menu, scroll and select Auto Status.

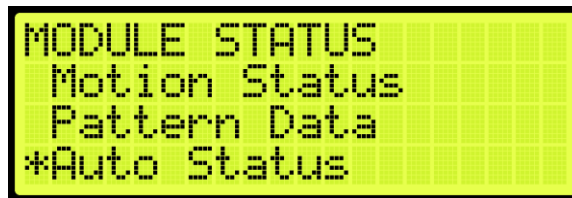

Figure 685: MODULE STATUS Menu – Auto Status

3. From the Auto Operation Status menu, view the state of operation.



Figure 686: Auto Operation Status Menu

40.9.4 Recall Status

The recall status displays the current state of the car. If car is recalled to a specific landing, the state changes to:

- **Unknown:** the car is not attempting to recall.
- **Moving:** the car is attempting to recall and is in motion or trying to move.
- **Stopped:** the car is attempting to recall but is currently stopped at a non-recall floor.
- **Recall Finished:** the car is stopped at the requested recall floor and its doors are in a requested state.

The following procedure describes how to view the recall status.

1. Navigate to MAIN MENU | DEBUG | Module Statuses (See Figure 67).
2. From the MODULE STATUS menu, scroll and select Recall Status.

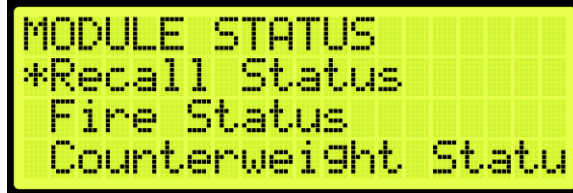

Figure 687: MODULE STATUS Menu – Recall Status

3. From the Recall Status menu, view the state of the recall status.

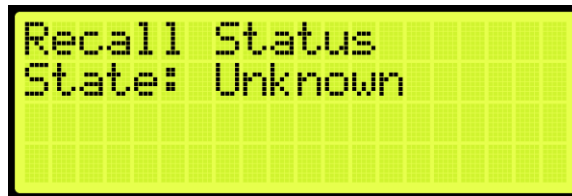

Figure 688: Recall Status Menu

40.9.5 Fire Status

The Fire Status displays if Fire Phase 1 and 2 are active.

The following procedure describes how to view the fire status.

1. Navigate to MAIN MENU | DEBUG | Module Statuses (See Figure 67).
2. From the MODULE STATUS menu, scroll and select Fire Status.

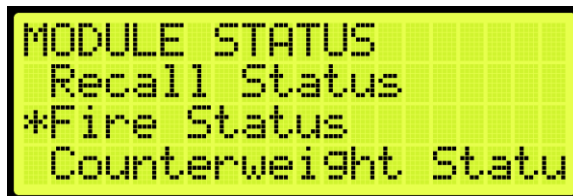

Figure 689: MODULE STATUS Menu – Fire Status

3. From the Fire Status menu, view if the fire operation is active.



```
Fire Status
Active: Fire I
FireII: Off
```

Figure 690: Fire Status Menu

40.9.6 Counterweight Status

The counterweight status displays the status of the counterweight derailment. The state of the counterweight is unknown unless the mode of operation is CW Derail where the state changes to GoingToNearestDestination. Upon arriving at the destination and with the doors open, the state shows no state.

The following procedure describes how to view the counterweight status.

1. Navigate to MAIN MENU | DEBUG | Module Statuses (See Figure 67).
2. From the MODULE STATUS menu, scroll and select Counterweight Status.

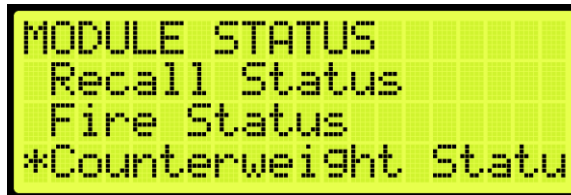

```
MODULE STATUS
Recall Status
Fire Status
*Counterweight Statu
```

Figure 691: MODULE STATUS Menu – Counterweight Status

3. From the Counterweight Status menu, view the status of the counterweight.



```
Counterweight Status
State: Unknown
```

Figure 692: Counterweight Status Menu

40.9.7 Floor Learn Status

The floor learning status displays if the state of the car is learning or not.

The following procedure describes how to view if a car is learning.

1. Navigate to MAIN MENU | DEBUG | Module Statuses (See Figure 67).
2. From the MODULE STATUS menu, scroll and select Floor Learn Status.

```

MODULE STATUS
Fire Status
Counterweight Statu
*Floor Learn Status

```

Figure 693: MODULE STATUS Menu – Floor Learn Status

- From the Floor Learn Status menu, view if the status of the car is learning or not.

```

Floor Learn Status
State: Not On Learn

```

Figure 694: Floor Learn Status Menu

40.10 Car Destination

The car destination displays the status of a car in the group.

The following procedure describes how to view the car destination status.

- Navigate to MAIN MENU | DEBUG | CAR DESTINATIONS (See Figure 67).
- From the DESTINATION menu, view the car destination information.

```

DESTINATION CAR1 [M]
Landing: 3
Type: DIR UP - F
Mask: 0x00000000

```

Figure 695: DESTINATION Menu

The Destination menu displays the following:

- Landing:** the landing number of the car's current destination. The bottom landing appears as 1.
- Type:** the destination assignment's call type.
 - CC – F: car call at front opening.
 - CC – R: car call at rear opening.
 - CC – B: car call at both front and rear openings.
 - DIR UP – F: hall call up or consecutive calls above at front opening.

- DIR UP – R: hall call up or consecutive calls above at rear opening.
 - DIR UP – B: hall call up or consecutive calls above at both openings.
 - DIR DN – F: hall call down or consecutive calls below at front opening.
 - DIR DN – R: hall call down or consecutive calls below at rear opening.
 - DIR DN – B: hall call down or consecutive calls below at both openings.
- **Mask:** the hall call mask for the car's current destination assignment based on the car's current hall destination mask front (HMF)/rear (HMR) fields. The hall call mask of the calls are cleared when the car arrives at the destination floor (See Section 18.4 Errors).

40.11 Run Counter

The run counter displays the total number of runs.

The following procedure describes how to view the run counter.

1. Navigate to MAIN MENU | DEBUG | RUN COUNTER (See Figure 68).
2. From the RUN COUNTER menu, view the number of runs the car has completed.



Figure 696: RUN COUNTER Menu

40.12 DebugRuns

The DebugRuns is where a random car and hall calls can be placed into the system.

40.12.1 Dwell Time

The dwell time is the time between debug test runs.

The following procedure describes how to set the dwell time.

1. Navigate to MAIN MENU | DEBUG | DEBUGRUNS (See Figure 68).
2. From the DEBUGRUNS menu, scroll and select Dwell Time.

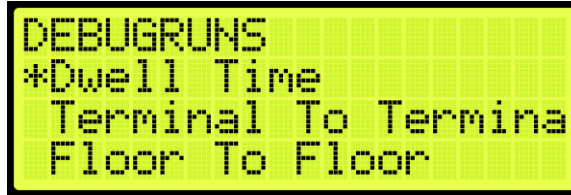

Figure 697: DEBUGRUNS Menu – Dwell Time

3. From the RUN DWELL TIME menu, set the time between test runs.

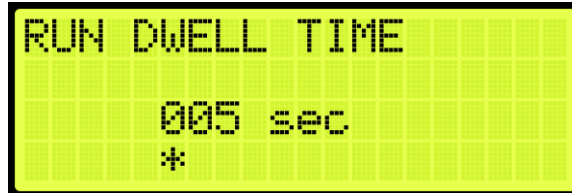

Figure 698: RUN DWELL TIME Menu

4. Scroll right and press Save.

40.12.2 Terminal to Terminal

The terminal to terminal allows for the car to run from the bottom to top terminal landing.

1. The following procedure describes how to set the car to run terminal to terminal.
2. Navigate to MAIN MENU | DEBUG | DEBUGRUNS (See Figure 68).
3. From the DEBUGRUNS menu, scroll and select Terminal to Terminal.

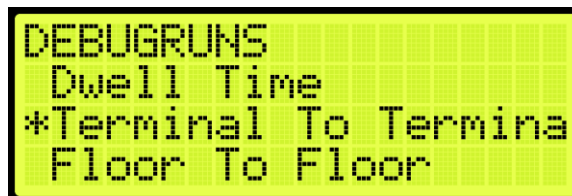

Figure 699: DEBUGRUNS Menu – Terminal To Terminal

4. From the TERMINAL TO TERMINAL menu, scroll and select if the front or rear doors open while running terminal to terminal.

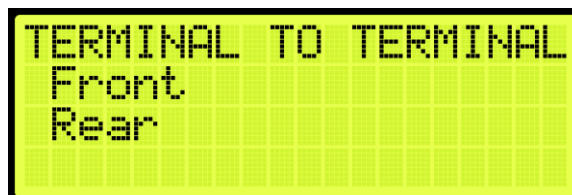

Figure 700: TERMINAL TO TERMINAL Menu – Front or Rear

- From the TERMINAL TO TERMINAL (FRONT or REAR) menu, scroll and select if enabling the car to stop at the other terminal with the doors that only open from the front or rear.

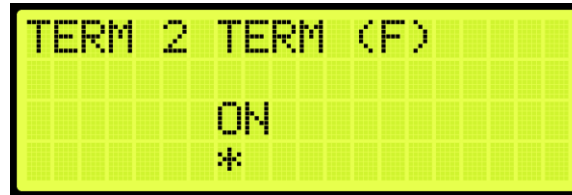

Figure 701: TERMINAL TO TERMINAL Menu

- Scroll right and press Save.

40.12.3 Floor to Floor

The floor to floor allows the car to stop at each floor that have doors that open from the front or doors that open from the rear.

The following procedure describes how to set the car to stop at each floor.

- Navigate to MAIN MENU | DEBUG | DEBUGRUNS (See Figure 68).
- From the DEBUGRUNS menu, scroll and select Floor To Floor.

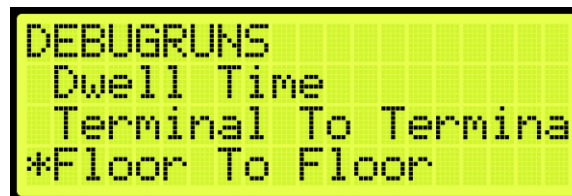

Figure 702: DEBUGRUNS Menu – Floor To Floor

- From the FLOOR TO FLOOR menu, scroll and select if checking front or rear doors.

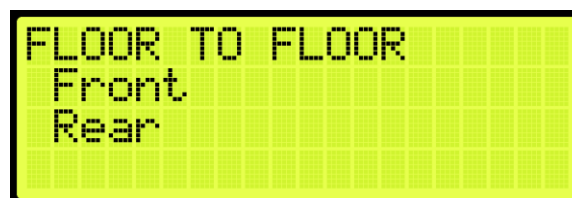

Figure 703: FLOOR TO FLOOR Menu – Front or Rear

- From the FLOOR 2 FLOOR (F or R) menu, scroll and select if enabling the car to stop at each floor with the doors that only open from the front or rear.



Figure 704: FLOOR 2 FLOOR (F) Menu

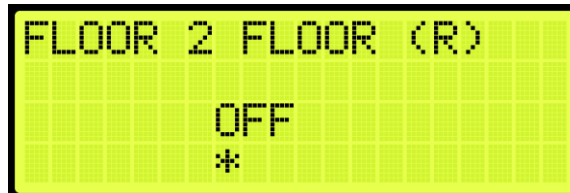

Figure 705: FLOOR 2 FLOOR (R) Menu

40.12.4 Random

Random calls are calls that are selected randomly. The random runs allow for the car to land at various floors in an arbitrary pattern.

The following procedure describes how to set the car to stop randomly at different landings.

1. Navigate to MAIN MENU | DEBUG | DEBUGRUNS (See Figure 68).
2. From the DEBUGRUNS menu, scroll and select Random.

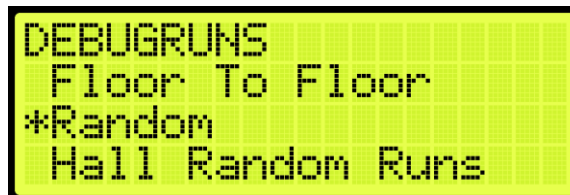

Figure 706: DEBUGRUNS Menu – Random

3. From the RANDOM menu, scroll and select if checking front or rear doors during a random run.

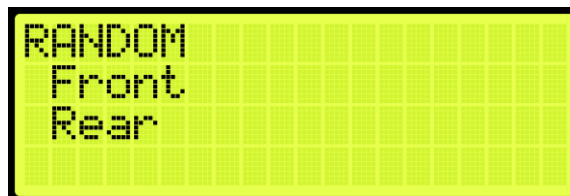

Figure 707: RANDOM Menu – Front or Rear

- From the RANDOM RUNS (F or R) menu, scroll and select if enabling the car to stop at random floors with the doors that only open from the front or rear.



Figure 708: RANDOM RUNS (F) Menu



Figure 709: RANDOM RUNS (R) Menu

- Scroll right and press Save.

40.12.5 Hall Random Runs

Hall random runs allow random hall calls to be initiated. The mask set in this menu is used to generate hall calls to simulate hall board requests (See Section 17.7 Hall Call Mask).

The following procedure describes how to set the car to stop on a floor by the randomly selected hall call.

- Navigate to MAIN MENU | DEBUG | DEBUGRUNS (See Figure 68).
- From the DEBUGRUNS menu, scroll and select Hall Random Runs.



Figure 710: DEBUGRUNS Menu – Hall Random Runs

3. From the HALL RANDOM RUNS menu, scroll and if hall calls are made randomly.



Figure 711: HALL RANDOM RUNS Menu

41 About

The About menu displays the following:

- Job Name
- Board Type
- Car Label
- Job Id
- Group Number
- Software Version

The following procedure describes how to view the job information.

1. Navigate to MAIN MENU | ABOUT (See Figure 44).
2. View the JOB ID information.

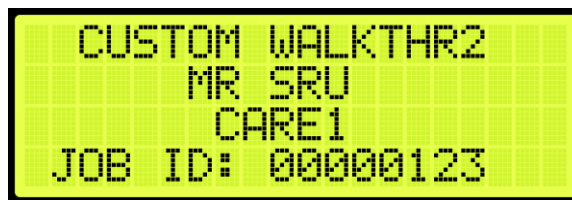

Figure 712: JOB ID

42 Faults

The Faults menu shows the faults reported by the software and hardware.

42.1 Active Faults

When a fault occurs, the description of the type of fault is displayed in Active Faults. Active faults can prevent the car from running.

The following procedure describes how to view the list of active faults.

1. Navigate to MAIN MENU | FAULTS | ACTIVE (See Figure 54).
2. From the Active Faults menu, view the list of faults that are preventing operation.



```
Active Faults
*CPLD: CPLD Governor
MRA: 120VAC Loss
MRB: No Fault
```

Figure 713: Active Faults Menu

3. From the Active Faults menu, scroll and press the right button for more description of the fault. See Section 42.4 List of Faults and Section 43.4 List of Alarms for more information.

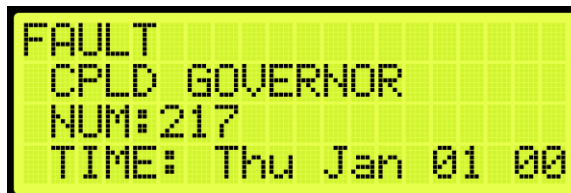

```
FAULT
CPLD GOVERNOR
NUM:217
TIME: Thu Jan 01 00
```

Figure 714: Fault Part 1 of 3

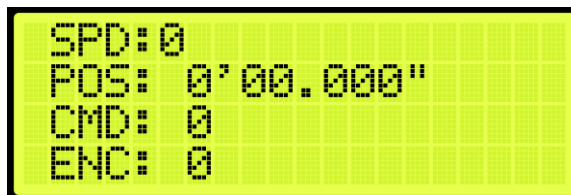

```
SPD: 0
POS: 0'00.000"
CMD: 0
ENC: 0
```

Figure 715: Fault Part 2 of 3

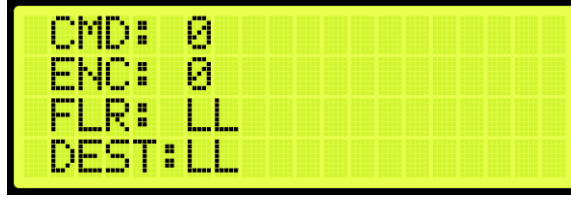

Figure 716: Fault Part 3 of 3

42.2 Logged Faults

All faults that have occurred are logged. The Logged Faults displays a history of the last 32 faults on the CT and COP boards and the last 256 faults on the MR board.

The following procedure describes how to view the list of logged faults.

1. Navigate to MAIN MENU | FAULTS | LOGGED (See Figure 54).
2. From the FAULT LOG menu, view the list of faults of faults that have occurred.



Figure 717: FAULT LOG Menu

42.3 Cleared Faults

Cleared faults deletes the history of recorded faults.

The following procedure describes how to clear the log.

1. Navigate to MAIN MENU | FAULTS | CLEAR LOG (See Figure 54).
2. From the CLEAR FAULT LOG menu, press the right button and select Yes.

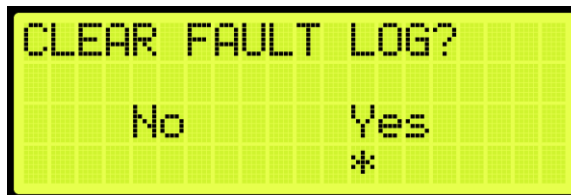

Figure 718: CLEAR FAULT LOG Menu

The table below lists the faults reported by software or hardware.

Table 57: Faults Reported by Software or Hardware

Option	Description
CPLD	Depicts faults generated by hardware system.
MRA	Depicts faults generated on processor A of the MR board.
MRB	Depicts faults generated on processor B of the MR board.
CTA	Depicts faults generated on processor A of the CT board.
CTB	Depicts faults generated on processor B of the CT board.
COPA	Depicts faults generated on processor A of the COP board.
COPB	Depicts faults generated on processor B of the COP board.

42.4 List of Faults

The following sections list the possible faults that could be encountered.

42.4.1 Brakes

The table below lists the faults related to Brakes.

Table 58: List of Faults related to Brakes

Fault Number	Name	Definition	Solution
189	BPS Stuck Closed	Brake pick switch feedback indicates brake is stuck closed during a run.	Reset machine room board to clear. Check BPS wiring, NC and correct brake voltage settings.
190	BPS Stuck Open	Brake pick switch feedback indicates brake is stuck open while car is stopped.	Reset machine room board to clear. Check BPS wiring, NC and correct brake voltage settings.
193	Brake Offline	Brake board communication was lost. Reported by the main system.	Check CAN bus wiring and termination.
194	Brake Unk.	Brake board reporting an unknown state.	NA
195	Brake POR Rst	Brake board recovering from reset due to power loss.	NA

Fault Number	Name	Definition	Solution
196	Brake WDT Rst	Brake board recovering from reset due to watch dog.	NA
197	Brake Comm Loss	Brake board reporting communication loss.	Check CAN bus wiring and termination.
198	Brake Gate Flt	Brake board reporting a gate driver fault.	Check wiring on brake board's high voltage connections.
199	Brake MOSFET	Brake board reporting MOSFET failure.	Check wiring on brake board's high voltage connections.
200	Brake Bus Rst	Brake board reporting CAN bus reset.	Check for short on the CAN bus.
201	Brake DIP	Brake board reporting DIP switch settings in conflict with another board.	Check system brake boards for identical DIP1 state.
202	Brake BOD Rst	Brake board recovering from reset due to voltage dip.	NA
203	Brake AC Loss	Brake board does not detect an AC voltage source. Only valid on 20A brake boards.	Check that the board has a valid AC power source.
204	EBrake Offline	Brake board communication was lost. Reported by the main system.	Check CAN bus wiring and termination.
205	EBrake Unk.	Brake board reporting an unknown state.	NA
206	EBrake POR Rst	Brake board recovering from reset due to power loss.	NA
207	EBrake WDT Rst	Brake board recovering from reset due to watch dog.	NA
208	EBrake Comm Loss	Brake board reporting communication loss.	Check CAN bus for correct wiring and termination.
209	EBrake Gate Flt	Brake board reporting a gate driver fault.	Check wiring on brake board's high voltage connections.
210	EBrake MOSFET	Brake board reporting MOSFET failure.	Check wiring on brake board's high voltage connections.
211	EBrake Bus Rst	Brake board reporting CAN bus reset.	Check for short on the CAN bus.

Fault Number	Name	Definition	Solution
212	EBrake DIP	Brake board reporting DIP switch settings in conflict with another board.	Check system brake boards for identical DIP1 state.
213	EBrake BOD Rst	Brake board recovering from reset due to voltage dip.	NA
214	EBrake AC Loss	Brake board does not detect an AC voltage source. Only valid on 20A brake boards.	Check that the board has a valid AC power source.
256	EBPS Stuck Closed	Emergency brake pick switch feedback indicates emergency brake is stuck closed during a run.	Check BPS wiring, NC and correct brake voltage settings.
257	EBPS Stuck Open	Emergency brake pick switch feedback indicates emergency brake is stuck open while car is stopped.	Check BPS wiring, NC and correct brake voltage settings.
802	Brake Overheat	Brake board has over heated.	NA
803	EBrake Overheat	Secondary brake board has over heated.	NA

42.4.2 CPLD

The table below lists the faults related to CPLD.

Table 59: List of Faults related to CPLD

Fault Number	Name	Definition	Solution
215	CPLD Startup	CPLD reporting a startup state.	NA
216	CPLD Unint Mov	CPLD reporting unintended movement.	Press the EBRK RST button to clear.
217	CPLD Governor	CPLD reporting a governor fault.	Press the EBRK RST button to clear.
218	CPLD Redundancy	CPLD reporting a redundancy fault.	NA
219	CPLD Comm Loss	CPLD reporting loss of CN2 network communication.	Check for miswiring on the CN2 network. Check CT/COP toggle switch.

Fault Number	Name	Definition	Solution
220	CPLD Non Bypass	CPLD reporting loss of a no bypass input.	Check machine room and car top safety inputs.
221	CPLD In Car	CPLD reporting loss of in car stop input.	Check COP SF2 input.
222	CPLD Insp.	CPLD reporting invalid inspection mode.	An invalid set of inspection switches are active.
223	CPLD SFH	CPLD reporting loss of SFH input.	Check machine room SFH input.
224	CPLD Gripper	NA	NA
225	CPLD Access	CPLD reporting invalid access switch and lock combination.	NA
226	CPLD Locks	CPLD reporting lock open.	NA
227	CPLD Doors	CPLD reporting gate switch open.	NA
228	CPLD Bypass Sw	CPLD reporting a bypass switch is active.	NA
229	CPLD Preflight	CPLD reporting preflight failure.	NA
338	MR CPLD Offline	Communication with machine room CPLD lost.	NA
339	CT CPLD Offline	Communication with car top CPLD lost.	NA
340	COP CPLD Offline	Communication with car operating panel CPLD lost.	NA
730	CPLD MR Startup	CPLD reporting a startup state.	NA
731	CPLD CT Startup	CPLD reporting a startup state.	NA
732	CPLD COP Startup	CPLD reporting a startup state.	NA
733	CPLD Unint Mov	CPLD reporting unintended movement.	Press the EBRK RST button to clear.
734	CPLD CT Comm	MR CPLD reporting loss of communication with CT CPLD.	Check for miswiring on the CN2 network. Check CT/COP toggle switch.
735	CPLD COP Comm	CT CPLD reporting loss of communication with COP CPLD.	Check for miswiring on the CN2 network. Check CT/COP toggle switch.

Fault Number	Name	Definition	Solution
736	CPLD 120 VAC	CPLD reporting loss of 120 AC supply.	NA
737	CPLD Gov	CPLD reporting loss of machine room governor input.	Press the EBRK RST button to clear.
738	CPLD Car Byp	CPLD reporting invalid activation of machine room car door bypass switch.	NA
739	CPLD Hall Byp	CPLD reporting invalid activation of machine room hall door bypass switch.	NA
740	CPLD SFM	CPLD reporting loss of machine room SFM input.	NA
741	CPLD SFH	CPLD reporting loss of machine room SFH input.	NA
742	CPLD PIT	CPLD reporting loss of machine room PIT input.	NA
743	CPLD BUF	CPLD reporting loss of machine room BUF input.	NA
744	CPLD TFL	CPLD reporting loss of machine room TFL input.	NA
745	CPLD BFL	CPLD reporting loss of machine room BFL input.	NA
746	CPLD CT SW	CPLD reporting loss of car top switch (CT-SF1) input.	NA
747	CPLD Esc Hatch	CPLD reporting loss of escape hatch (CT-SF2) input.	NA
748	CPLD Car Safety	CPLD reporting loss of car safeties (CT-SF3) input.	NA
749	CPLD IC Stop	CPLD reporting loss of in car stop switch (COP-SF2) input.	NA
750	CPLD Fire Stop	CPLD reporting loss of fire stop switch (COP-SF3) input.	NA
751	CPLD Insp.	CPLD reporting invalid inspection mode.	NA

Fault Number	Name	Definition	Solution
752	CPLD Access	CPLD reporting invalid hoistway access move request.	NA
753	CPLD LFT	CPLD reporting multiple locks are open or a lock is open outside of door zone.	NA
754	CPLD LFM	CPLD reporting multiple locks are open or a lock is open outside of door zone.	NA
755	CPLD LFB	CPLD reporting multiple locks are open or a lock is open outside of door zone.	NA
756	CPLD LRT	CPLD reporting multiple locks are open or a lock is open outside of door zone.	NA
757	CPLD LRM	CPLD reporting multiple locks are open or a lock is open outside of door zone.	NA
758	CPLD LRB	CPLD reporting multiple locks are open or a lock is open outside of door zone.	NA
759	CPLD GSWF	CPLD reporting gate switch is open outside of door zone.	NA
760	CPLD GSWR	CPLD reporting gate switch is open outside of door zone.	NA
761	PF Pit Insp	CPLD reporting preflight check failed.	NA
762	PF Lnd Insp	CPLD reporting preflight check failed.	NA
763	PF BFL	CPLD reporting preflight check failed.	NA
764	PF TFL	CPLD reporting preflight check failed.	NA

Fault Number	Name	Definition	Solution
765	PF BUF	CPLD reporting preflight check failed.	NA
766	PF PIT	CPLD reporting preflight check failed.	NA
767	PF GOV	CPLD reporting preflight check failed.	NA
768	PF SFH	CPLD reporting preflight check failed.	NA
769	PF SFM	CPLD reporting preflight check failed.	NA
770	PF LFT	CPLD reporting preflight check failed.	NA
771	PF LFM	CPLD reporting preflight check failed.	NA
772	PF LFB	CPLD reporting preflight check failed.	NA
773	PF LRT	CPLD reporting preflight check failed.	NA
774	PF LRM	CPLD reporting preflight check failed.	NA
775	PF LRB	CPLD reporting preflight check failed.	NA
776	PF Hall Byp	CPLD reporting preflight check failed.	NA
777	PF Car Byp	CPLD reporting preflight check failed.	NA
778	PF MR Insp	CPLD reporting preflight check failed.	NA
779	PF C Pick Byp	CPLD reporting preflight check failed.	NA
780	PF M Pick Byp	CPLD reporting preflight check failed.	NA
781	PF M Drop Grip	CPLD reporting preflight check failed.	NA
782	PF C Drop Grip	CPLD reporting preflight check failed.	NA
783	PF C Pick Grip	CPLD reporting preflight check failed.	NA
784	PF M Pick Grip	CPLD reporting preflight check failed.	NA
785	PF M Drop Byp	CPLD reporting preflight check failed.	NA

Fault Number	Name	Definition	Solution
786	PF C Drop Byp	CPLD reporting preflight check failed.	NA
787	CPLD MR Unk.	CPLD reporting out of range error.	NA
788	PF CT Sw	CPLD reporting preflight check failed.	NA
789	PF Esc Hatch	CPLD reporting preflight check failed.	NA
790	PF Car Safety	CPLD reporting preflight check failed.	NA
791	PF CT Insp	CPLD reporting preflight check failed.	NA
792	PF GSWF	CPLD reporting preflight check failed.	NA
793	PF GSWR	CPLD reporting preflight check failed.	NA
794	PF DZF	CPLD reporting preflight check failed.	NA
795	PF DZR	CPLD reporting preflight check failed.	NA
796	CPLD CT Unk	CPLD reporting out of range error.	NA
797	PF HA Insp	CPLD reporting preflight check failed.	NA
798	PF IC Stop	CPLD reporting preflight check failed.	NA
799	PF FSS	CPLD reporting preflight check failed.	NA
800	PF IC Insp	CPLD reporting preflight check failed.	NA
801	CPLD COP Unk	CPLD reporting out of range error.	NA
1053	CPLD TFL2	CPLD reporting loss of machine room TFL2 input.	NA

42.4.3 DIP Switches

The table below lists the faults related to DIP Switches.

Table 60: List of Faults related to DIP Switches

Fault Number	Name	Definition	Solution
258	Inv. DIP B2	Rear door DIP switch and parameter do not match.	Match DIP and parameter setting.
259	Inv. DIP B3	Enable landing inspection DIP switch and parameter do not match.	Match DIP and parameter setting.
260	Inv. DIP B4	Enable pit inspection DIP switch and parameter do not match.	Match DIP and parameter setting.
261	Inv. DIP B8	DIP B8 is on while not performing the unintended movement acceptance test.	Move to unintended movement acceptance test or clear DIP B8.
262	Inv. DIP A6	Construction mode is required when the motor learn DIP switch is ON.	Move to construction mode or clear DIP A6.

42.4.4 Doors

The table below lists the faults related to Doors.

Table 61: List of Faults related to Doors

Fault Number	Name	Definition	Solution
76	Door Invalid	Necessary door inputs are not programmed, and the doors cannot function.	"Program the necessary door inputs.
96	At Floor No DZ	Car is at a learned floor level but is missing the door zone signal.	Adjust the learned floor position or door zone magnet at the fault position.
98	Door F Jumper GSW	Gate switch jumper was detected. Gate switch input must go low to clear.	Remove jumper or increase the door jumper timeout setting.
99	Door F Jumper Lock	Lock jumper was detected. A lock input must go low to clear.	Remove jumper or increase the door jumper timeout setting.
100	Door F Locks Open	A lock was stuck open when closing doors.	NA
101	Door F GSW Open	Gate switch stuck open when closing doors.	NA
102	Door F Fail Open	Door failed to open.	NA
103	Door F Fail Close	Door failed to close.	NA
104	Door F Fail Nudge	NA	NA

Fault Number	Name	Definition	Solution
105	Door F Stalled	NA	NA
106	Door F Lost Signal	Door signals were unexpectedly lost.	NA
107	Door R Jumper GSW	Gate switch jumper was detected. Gate switch input must go low to clear.	Remove jumper or increase the door jumper timeout setting.
108	Door R Jumper Lock	Lock jumper was detected. A lock input must go low to clear.	Remove jumper or increase the door jumper timeout setting.
109	Door R Locks Open	A lock was stuck open when closing doors.	NA
110	Door R GSW Open	Gate switch stuck open when closing doors.	NA
111	Door R Fail Open	Door failed to open.	NA
112	Door R Fail Close	Door failed to close.	NA
113	Door R Fail Nudge	NA	NA
114	Door R Stalled	NA	NA
115	Door R Lost Signal	Door signals were unexpectedly lost.	NA
234	DZ Stuck Hi	Door zone stuck high and over six inches from the closest learned floor position.	Check DZ input wiring (CT-503/504). Check for obstruction of the DZ sensor.
805	Door OVSP DPM-F	Car speed exceeded 150 fpm with front door position monitor open.	Confirm system and drive contract speed match. Check door contacts and wiring.
806	Door OVSP DPM-R	Car speed exceeded 150 fpm with rear door position monitor open.	Confirm system and drive contract speed match. Check door contacts and wiring.
808	PHE Test Fail	Freight door photoeye test has failed.	Check light curtain hardware.

42.4.5 Emergency Power

The table below lists the faults related to Emergency Power.

Table 62: List of Faults related to Emergency Power

Fault Number	Name	Definition	Solution
334	E-Power OOS	Car is on emergency power and not configured to return to automatic operation.	NA

Fault Number	Name	Definition	Solution
725	Inv. EPWR Spd	Emergency power speed setting is outside the valid range.	Set epower speed to a value from 10 to the configured contract speed.

42.4.6 Expansion Boards

The table below lists the faults related to Expansion Boards.

Table 63: List of Faults related to Expansion Boards

Fault Number	Name	Definition	Solution
269	EXP 1-8 Comm	Communication loss between system and master or master and slave expansions	Check expansion 1-8 CAN bus wiring
270	EXP 9-16 Comm	Communication loss between system and master or master and slave expansions	Check expansion 9-16 CAN bus wiring
271	EXP 17-24 Comm	Communication loss between system and master or master and slave expansions	Check expansion 17-24 CAN bus wiring
272	EXP 25-32 Comm	Communication loss between system and master or master and slave expansions	Check expansion 25-32 CAN bus wiring
273	EXP 33-40 Comm	Communication loss between system and master or master and slave expansions	Check expansion 33-40 CAN bus wiring
274	EXP 41-48 Comm	Communication loss between system and master or master and slave expansions	Check expansion 41-48 CAN bus wiring
275	EXP 49-56 Comm	Communication loss between system and master or master and slave expansions	Check expansion 49-56 CAN bus wiring
276	EXP 57-64 Comm	Communication loss between system and master or master and slave expansions	Check expansion 57-64 CAN bus wiring

Fault Number	Name	Definition	Solution
277	EXP 65-72 Comm	Communication loss between system and master or master and slave expansions	Check expansion 65-72 CAN bus wiring
278	EXP 73-80 Comm	Communication loss between system and master or master and slave expansions	Check expansion 73-80 CAN bus wiring
279	EXP 81-88 Comm	Communication loss between system and master or master and slave expansions	Check expansion 81-88 CAN bus wiring
280	EXP 89-96 Comm	Communication loss between system and master or master and slave expansions	Check expansion 89-96 CAN bus wiring
281	EXP 97-104 Comm	Communication loss between system and master or master and slave expansions	Check expansion 97-104 CAN bus wiring
282	EXP 105-112 Comm	Communication loss between system and master or master and slave expansions	Check expansion 105-112 CAN bus wiring
283	EXP 113-120 Comm	Communication loss between system and master or master and slave expansions	Check expansion 113-120 CAN bus wiring
284	EXP DIP 1	Two or more expansion boards have the same master DIP switch 1 settings.	Check if two or more master expansions have master 1 dip settings
285	EXP DIP 2	Two or more expansion boards have the same master DIP switch 2 settings.	Check if two or more master expansions have master 2 dip settings
286	EXP DIP 3	Two or more expansion boards have the same master DIP switch 3 settings.	Check if two or more master expansions have master 3 dip settings

Fault Number	Name	Definition	Solution
287	EXP DIP 4	Two or more expansion boards have the same master DIP switch 4 settings.	Check if two or more master expansions have master 4 dip settings
288	EXP DIP 5	Two or more expansion boards have the same master DIP switch 5 settings.	Check if two or more master expansions have master 5 dip settings
289	EXP DIP 6	Two or more expansion boards have the same master DIP switch 6 settings.	Check if two or more master expansions have master 6 dip settings
290	EXP DIP 7	Two or more expansion boards have the same master DIP switch 7 settings.	Check if two or more master expansions have master 7 dip settings
291	EXP DIP 8	Two or more expansion boards have the same master DIP switch 8 settings.	Check if two or more master expansions have master 8 dip settings
292	EXP DIP 9	Two or more expansion boards have the same master DIP switch 9 settings.	Check if two or more master expansions have master 9 dip settings
293	EXP DIP 10	Two or more expansion boards have the same master DIP switch 10 settings.	Check if two or more master expansions have master 10 dip settings
294	EXP DIP 11	Two or more expansion boards have the same master DIP switch 11 settings.	Check if two or more master expansions have master 11 dip settings
295	EXP DIP 12	Two or more expansion boards have the same master DIP switch 12 settings.	Check if two or more master expansions have master 12 dip settings
296	EXP DIP 13	Two or more expansion boards have the same master DIP switch 13 settings.	Check if two or more master expansions have master 13 dip settings

Fault Number	Name	Definition	Solution
297	EXP DIP 14	Two or more expansion boards have the same master DIP switch 14 settings.	Check if two or more master expansions have master 14 dip settings
298	EXP DIP 15	Two or more expansion boards have the same master DIP switch 15 settings.	Check if two or more master expansions have master 15 dip settings

42.4.7 Fire

The table below lists the faults related to Fire.

Table 64: List of Faults related to Fire

Fault Number	Name	Definition	Solution
97	Fire Stop Switch	Fire stop switch (COP-SF3) input is missing.	Check wiring and safety contacts.
336	Inv. Fire Main	Main fire recall floor and opening are invalid.	NA
337	Inv. Fire Alt	Alternate fire recall floor and opening are invalid.	NA

42.4.8 Floors

The table below lists the faults related to Floors.

Table 65: List of Faults relate to Floors

Fault Number	Name	Definition	Solution
84	Inv. Num Floors	Number of floors setting is outside the valid range.	Set number of floors to a value from 2 to 64.
91	Need To Learn	Learned floor positions are invalid.	Set machine room DIP A5 and follow on screen instructions to learn floor positions.
335	Inv. Parking	Parking floor is set to a landing with no openings.	NA

42.4.9 Hall Boards

The table below lists the faults related to Hall Boards.

Table 66: List of Faults related to Hall Boards

Fault Number	Name	Definition	Solution
299	Inv. Hall Mask	There is overlap between the hall call, medical, and swing masks.	NA

42.4.10 Landing System

The table below lists the faults related to Landing System.

Table 67: List of Faults related to Landing System

Fault Number	Name	Definition	Solution
235	Position Limit	Car moving outside the mode defined position limit.	Option to bypass term limits is available.
236	Inv. Manual Run	Attempting a manual run outside specified the current position limits.	Option to bypass term limits is available.
306	CEDES1 Offline	Communication with CEDES channel 1 was lost.	Check camera wiring.
307	CEDES1 Read	CEDES channel 1 reporting a failure to read error.	Clean the tape. Align the tape with the camera.
308	CEDES1 Close	CEDES channel 1 reporting the tape is aligned too close relative to the camera.	Clean the tape. Align the tape with the camera.
309	CEDES1 Far	CEDES channel 1 reporting the tape is aligned too far relative to the camera.	Clean the tape. Align the tape with the camera.
310	CEDES1 Left	CEDES channel 1 reporting the tape is aligned too left relative to the camera.	Clean the tape. Align the tape with the camera.
311	CEDES1 Right	CEDES channel 1 reporting the tape is aligned too right relative to the camera.	Clean the tape. Align the tape with the camera.
312	CEDES1 Internal	CEDES channel 1 reporting an internal error.	NA
313	CEDES1 Comm.	CEDES channel 1 reporting a communication error.	NA
314	CEDES1 X1 Pos	CEDES channel 1 reporting a position cross check error.	NA

Fault Number	Name	Definition	Solution
315	CEDES1 X1 Vel	CEDES channel 1 reporting a velocity cross check error.	NA
316	CEDES1 X1 Both	CEDES channel 1 reporting a cross check error.	NA
317	CEDES1 X2 Pos	CEDES channel 1 reporting a position cross check error.	NA
318	CEDES1 X2 Vel	CEDES channel 1 reporting a velocity cross check error.	NA
319	CEDES1 X2 Both	CEDES channel 1 reporting a cross check error.	NA
320	CEDES2 Offline	Communication with CEDES channel 2 was lost.	Check camera wiring.
321	CEDES2 Read	CEDES channel 2 reporting a failure to read error.	Clean the tape. Align the tape with the camera.
322	CEDES2 Close	CEDES channel 2 reporting the tape is aligned too close relative to the camera.	Clean the tape. Align the tape with the camera.
323	CEDES2 Far	CEDES channel 2 reporting the tape is aligned too far relative to the camera.	Clean the tape. Align the tape with the camera.
324	CEDES2 Left	CEDES channel 2 reporting the tape is aligned too left relative to the camera.	Clean the tape. Align the tape with the camera.
325	CEDES2 Right	CEDES channel 2 reporting the tape is aligned too right relative to the camera.	Clean the tape. Align the tape with the camera.
326	CEDES2 Internal	CEDES channel 2 reporting an internal error.	NA
327	CEDES2 Comm.	CEDES channel 2 reporting a communication error.	NA

Fault Number	Name	Definition	Solution
328	CEDES2 X1 Pos	CEDES channel 2 reporting a position cross check error.	NA
329	CEDES2 X1 Vel	CEDES channel 2 reporting a velocity cross check error.	NA
330	CEDES2 X1 Both	CEDES channel 2 reporting a cross check error.	NA
331	CEDES2 X2 Pos	CEDES channel 2 reporting a position cross check error.	NA
332	CEDES2 X2 Vel	CEDES channel 2 reporting a velocity cross check error.	NA
333	CEDES2 X2 Both	CEDES channel 2 reporting a cross check error.	NA
654	Inv. Land Off	Group landing offset setting it outside valid range.	The sum of the landing offset and the car's number of floors should be less than the max supported landings (typically 64). Currently this offset is also bounded to less than 32.
663	CEDES3 Offline	Communication with ETSL CEDES channel 2 was lost.	Check camera wiring.
664	CEDES3 Read	ETSL CEDES channel 2 reporting a failure to read error.	Clean the tape. Align the tape with the camera.
665	CEDES3 Close	ETSL CEDES channel 2 reporting the tape is aligned too close relative to the camera.	Clean the tape. Align the tape with the camera.
666	CEDES3 Far	ETSL CEDES channel 2 reporting the tape is aligned too far relative to the camera.	Clean the tape. Align the tape with the camera.
667	CEDES3 Left	ETSL CEDES channel 2 reporting the tape is aligned too left relative to the camera.	Clean the tape. Align the tape with the camera.

Fault Number	Name	Definition	Solution
668	CEDES3 Right	ETSL CEDES channel 2 reporting the tape is aligned too right relative to the camera.	Clean the tape. Align the tape with the camera.
669	CEDES3 Internal	ETSL CEDES channel 2 reporting an internal error.	NA
670	CEDES3 Comm.	ETSL CEDES channel 2 reporting a communication error.	NA
671	CEDES3 X1 Pos	ETSL CEDES channel 2 reporting a position cross check error.	NA
672	CEDES3 X1 Vel	ETSL CEDES channel 2 reporting a velocity cross check error.	NA
673	CEDES3 X1 Both	ETSL CEDES channel 2 reporting a cross check error.	NA
674	CEDES3 X2 Pos	ETSL CEDES channel 2 reporting a position cross check error.	NA
675	CEDES3 X2 Vel	ETSL CEDES channel 2 reporting a velocity cross check error.	NA
676	CEDES3 X2 Both	ETSL CEDES channel 2 reporting a cross check error.	NA
881	Learn Slowdowns	Learned slowdown distances are invalid.	(Hydro Only) Check learned slowdown distances. To learn slowdown distances, turn ON machine room DIP A5, and turn ON Learn_Slowdowns (01-253) parameter. Then position the car at the bottom landing and follow on screen instructions to learn slowdowns in the up direction. Then position the car at the top landing and follow on screen instructions to learn slowdowns in the down direction.
1001	CEDES1 CRC FAILURE	CEDES channel 1 Data CRC check error.	NA

Fault Number	Name	Definition	Solution
1002	CEDES2 CRC FAILURE	CEDES channel 2 Data CRC check error.	NA

42.4.11 Miscellaneous

The table below lists the faults under Miscellaneous.

Table 68: List of Faults under Miscellaneous

Fault Number	Name	Definition	Solution
75	Flood OOS	Car is out of service on flood operation.	NA
77	MRA CPU Stop Sw	CPU stop switch is ON for the machine room board.	Turn off DIP A1 on the machine room board.
78	MRB CPU Stop Sw	CPU stop switch is ON for the machine room board.	Turn off DIP A1 on the machine room board.
79	CTA CPU Stop Sw	CPU stop switch is ON for the car top board.	Turn off DIP A1 on the car top board.
80	CTB CPU Stop Sw	CPU stop switch is ON for the car top board.	Turn off DIP A1 on the car top board.
81	COPA CPU Stop Sw	CPU stop switch is ON for the car operating panel board.	Turn off DIP A1 on the car operating panel board.
82	COPB CPU Stop Sw	CPU stop switch is ON for the car operating panel board.	Turn off DIP A1 on the car operating panel board.
83	Need To Cycle Pwr MR	A system configuration parameter was changed. The system must be power cycled.	Cycle power to the system.
116	Max Runtime	Car made a single run that exceeded the run time limit.	Adjust max runtime setting.
124	MRA Offline (CTA)	MR-A processor reported offline by CT-A processor.	Check wiring of communication lines. Check for stalled HB LEDs.
125	MRA Offline (COPA)	MR-A processor reported offline by COP-A processor.	Check wiring of communication lines. Check for stalled HB LEDs.
126	MRA Offline (MRB)	MR-A processor reported offline by MR-B processor.	Check wiring of communication lines. Check for stalled HB LEDs.

Fault Number	Name	Definition	Solution
127	CTA Offline (MRA)	CT-A processor reported offline by MR-A processor.	Check wiring of communication lines. Check for stalled HB LEDs.
128	CTA Offline (COPA)	CT-A processor reported offline by COP-A processor.	Check wiring of communication lines. Check for stalled HB LEDs.
129	CTA Offline (CTB)	CT-A processor reported offline by CT-B processor.	Check wiring of communication lines. Check for stalled HB LEDs.
130	COPA Offline (MRA)	COP-A processor reported offline by MR-A processor.	Check wiring of communication lines. Check for stalled HB LEDs.
131	COPA Offline (CTA)	COP-A processor reported offline by CT-A processor.	Check wiring of communication lines. Check for stalled HB LEDs.
132	COPA Offline (COPB)	COP-A processor reported offline by COP-B processor.	Check wiring of communication lines. Check for stalled HB LEDs.
133	MRB Offline (MRA)	MR-B processor reported offline by MR-A processor.	Check wiring of communication lines. Check for stalled HB LEDs.
134	CTB Offline (CTA)	CT-B processor reported offline by CT-A processor.	Check wiring of communication lines. Check for stalled HB LEDs.
135	COPB Offline (COPA)	COP-B processor reported offline by COP-A processor.	Check wiring of communication lines. Check for stalled HB LEDs.
136	MRA Board Rst	Processor was reset, triggered by power loss or user reset.	NA
137	MRB Board Rst	Processor was reset, triggered by power loss or user reset.	NA
138	CTA Board Rst	Processor was reset, triggered by power loss or user reset.	NA
139	CTB Board Rst	Processor was reset, triggered by power loss or user reset.	NA
140	COPA Board Rst	Processor was reset, triggered by power loss or user reset.	NA

Fault Number	Name	Definition	Solution
141	COPB Board Rst	Processor was reset, triggered by power loss or user reset.	NA
142	MRA WDT Rst	Processor was reset, triggered by watch dog.	NA
143	MRB WDT Rst	Processor was reset, triggered by watch dog.	NA
144	CTA WDT Rst	Processor was reset, triggered by watch dog.	NA
145	CTB WDT Rst	Processor was reset, triggered by watch dog.	NA
146	COPA WDT Rst	Processor was reset, triggered by watch dog.	NA
147	COPB WDT Rst	Processor was reset, triggered by watch dog.	NA
148	MRA BOD Rst	Processor was reset, triggered by dip in board voltage.	NA
149	MRB BOD Rst	Processor was reset, triggered by dip in board voltage.	NA
150	CTA BOD Rst	Processor was reset, triggered by dip in board voltage.	NA
151	CTB BOD Rst	Processor was reset, triggered by dip in board voltage.	NA
152	COPA BOD Rst	Processor was reset, triggered by dip in board voltage.	NA
153	COPB BOD Rst	Processor was reset, triggered by dip in board voltage.	NA
171	FRAM Defaulting	New FRAM chip detected, and formatting is in progress.	NA
172	FRAM Timeout	FRAM read or write request was unsuccessful.	NA
173	FRAM Default Fail	Attempt to format FRAM chip has failed.	NA

Fault Number	Name	Definition	Solution
174	120VAC Loss	Machine room 120 VAC supply is missing.	Check wiring and safety contacts.
246	Car Overloaded	Car is overloaded.	Remove weight from the car.
254	Regen Fault	Regen unit reporting a fault state.	Check regen status and the regen fault input wiring.
230	Riser Offline 1	NA	NA
231	Riser Offline 2	NA	NA
232	Riser Offline 3	NA	NA
233	Riser Offline 4	NA	NA
263	CT Insp Reqs IC Insp	Both IC and CT inspection switches are required for CT inspection operation.	Assert both IC and CT inspection switches. Optionally turn off this parameter enabled option.
300	OOS Fault	Car has been taken out of service. Triggering source is undefined.	Clear OOS by moving to inspection mode.
301	Inv. Group ID	Two or more group cars have the same car ID.	NA
341	DG Expired	Car network datagram expired.	NA
342	Drive Offline	Communication with drive was lost.	Check the wiring of the communication lines between the machine room and drive.
343	DSD Not Rdy	A drive fault exists. Drive is not ready.	Refer to the DSD drive manual.
344	DSD OVSP	Drive issuing a tach overspeed fault (see DSD manual F97).	Refer to the DSD drive manual.
345	DSD Tach Loss	Drive issuing a tach loss fault (see DSD manual F98).	Refer to the DSD drive manual.
346	DSD Tach Rev	Drive issuing a reverse tach fault (see DSD manual F99).	Refer to the DSD drive manual.
347	DSD Overload	Drive issuing a motor over-load fault (see DSD manual F400).	Refer to the DSD drive manual.
348	DSD Field Curr	Drive issuing an excessive field current fault (see DSD manual F401).	Refer to the DSD drive manual.

Fault Number	Name	Definition	Solution
349	DSD Contact.	Drive issuing a contactor failure fault (see DSD manual F402).	Refer to the DSD drive manual.
350	DSD CEMF	Drive issuing a CEMF limit fault (see DSD manual F407/F408).	Refer to the DSD drive manual.
351	DSD Estop	Drive issuing an E-Stop circuit fault (see DSD manual).	Refer to the DSD drive manual.
352	DSD Loop	Drive issuing a loop fault (see DSD manual F900).	Refer to the DSD drive manual.
353	DSD PCU	Drive issuing a PCU IST fault (see DSD manual F901).	Refer to the DSD drive manual.
354	DSD Line Sync	Drive issuing a line sync fault (see DSD manual F903).	Refer to the DSD drive manual.
355	DSD Line Lo	Drive issuing a low line fault (see DSD manual F904).	Refer to the DSD drive manual.
356	DSD Field Loss	Drive issuing a field loss fault (see DSD manual F905).	Refer to the DSD drive manual.
357	DSD Line Droop	Drive issuing a line droop fault (see DSD manual F406).	Refer to the DSD drive manual.
358	DSD Comm.	Drive reporting a communication loss fault (see DSD manual).	Check the wiring of the communication lines between the machine room and drive.
359	DRV OVERVOLT FLT	Drive reporting an overvolt fault.	Refer to the HPV drive manual.
360	DRV UNDERVOLT FLT	Drive reporting an undervolt fault.	Refer to the HPV drive manual.
361	DRV OVERCURRE FLT	Drive reporting an overcurrent fault.	Refer to the HPV drive manual.
362	DRV FUSE FLT	Drive reporting a fuse fault.	Refer to the HPV drive manual.
363	DRV REVERSE TACH	Drive reporting reverse tach fault.	Refer to the HPV drive manual.
364	DRV PHASE LOSS	Drive reporting a phase loss fault.	Refer to the HPV drive manual.

Fault Number	Name	Definition	Solution
365	DRV CURR REG FLT	Drive reporting a current regulator fault.	Refer to the HPV drive manual.
366	DRV OVERSPEED FLT	Drive reporting an overspeed fault.	Refer to the HPV drive manual.
367	DRV CHARGE FLT	Drive reporting a charge fault.	Refer to the HPV drive manual.
368	DRV DRIVE OVRLOAD	Drive reporting a drive overload fault.	Refer to the HPV drive manual.
369	DRV OVERTEMP FLT	Drive reporting an overtemperature fault.	Refer to the HPV drive manual.
370	DRV ENCODER FLT	Drive reporting an encoder fault.	Refer to the HPV drive manual.
371	DRV GROUND FLT	Drive reporting a ground fault.	Refer to the HPV drive manual.
372	DRV CONTACTOR FLT	Drive reporting a contactor fault.	Refer to the HPV drive manual.
373	DRV BRK PICK FLT	Drive reporting a brake pick fault.	Refer to the HPV drive manual.
374	DRV BRK HOLD FLT	Drive reporting a brake hold fault.	Refer to the HPV drive manual.
375	DRV EXTRN FLT 1	Drive reporting an external fault 1.	Refer to the HPV drive manual.
376	DRV EXTRN FLT 2	Drive reporting an external fault 2.	Refer to the HPV drive manual.
377	DRV EXTRN FLT 3	Drive reporting an external fault 3.	Refer to the HPV drive manual.
378	DRV BRAKE FLT	Drive reporting a brake fault.	Refer to the HPV drive manual.
379	DRV CUBE ID FLT	Drive reporting a cube ID fault.	Refer to the HPV drive manual.
380	DRV MOTOR ID FLT	Drive reporting a motor ID fault.	Refer to the HPV drive manual.
381	MAG23	Drive reporting an undefined MAG 23 fault.	Refer to the HPV drive manual.
382	DRV SETUP FLT 1	Drive reporting a setup fault 1.	Refer to the HPV drive manual.
383	DRV SETUP FLT 2	Drive reporting a setup fault 2.	Refer to the HPV drive manual.
384	DRV SETUP FLT 3	Drive reporting a setup fault 3.	Refer to the HPV drive manual.
385	DRV SETUP FLT 4	Drive reporting a setup fault 4.	Refer to the HPV drive manual.

Fault Number	Name	Definition	Solution
386	DRV SETUP FLT 5	Drive reporting a setup fault 5.	Refer to the HPV drive manual.
387	DRV DCU DATA FLT	Drive reporting a DCU data fault.	Refer to the HPV drive manual.
388	DRV PCU DATA FLT	Drive reporting a PCU data fault.	Refer to the HPV drive manual.
389	DRV CUBE DATA FLT	Drive reporting a cube data fault.	Refer to the HPV drive manual.
390	DRV MTR DATA FLT	Drive reporting a motor data fault.	Refer to the HPV drive manual.
391	DRV SRL TIMEOUT	Drive reporting a serial comm timeout.	Refer to the HPV drive manual.
392	DRV SETUP FLT 6	Drive reporting a setup fault 6.	Refer to the HPV drive manual.
393	DRV SETUP FLT 7	Drive reporting a setup fault 7.	Refer to the HPV drive manual.
394	DRV TQLim2Hi4Cube	Drive reporting a torque limit fault.	Refer to the HPV drive manual.
395	DRV SETUP FLT 8	Drive reporting a setup fault 8.	Refer to the HPV drive manual.
396	DRV V/HZ FLT	Drive reporting a V/HZ fault.	Refer to the HPV drive manual.
397	MAG39	Drive reporting an undefined MAG 39 fault.	Refer to the HPV drive manual.
398	DRV EXTRN FLT 4	Drive reporting an external fault 4.	Refer to the HPV drive manual.
399	MAG41	Drive reporting an undefined MAG 41 fault.	Refer to the HPV drive manual.
400	MAG42	Drive reporting an undefined MAG 42 fault.	Refer to the HPV drive manual.
401	DRV RTR NOT ALIGN	Drive reporting rotor not aligned.	Refer to the HPV drive manual.
402	DRV ENCDR CRC ERR	Drive reporting encoder CRC error.	Refer to the HPV drive manual.
403	MAG45	Drive reporting an undefined MAG 45 fault.	Refer to the HPV drive manual.
404	DRV MOTOR PHASE FLT	Drive reporting a motor phase fault.	Refer to the HPV drive manual.
405	DRV Z MARKER LOST	Drive reporting a Z marker lost fault.	Refer to the HPV drive manual.
406	DRV STALL FLT	Drive reporting a stall fault.	Refer to the HPV drive manual.

Fault Number	Name	Definition	Solution
407	MAG49	Drive reporting an undefined MAG 49 fault.	Refer to the HPV drive manual.
408	MAG50	Drive reporting an undefined MAG 50 fault.	Refer to the HPV drive manual.
409	DRV ENDAT MISMATCH	Drive reporting ENDAT mismatch.	Refer to the HPV drive manual.
410	DRV DB VOLT	Drive reporting DB voltage fault.	Refer to the HPV drive manual.
411	DRV MSPD TIMER FLT	Drive reporting a multi-step speed delay fault.	Refer to the HPV drive manual.
412	DRV SHORT CIRCUIT	Drive reporting a short circuit fault.	Refer to the HPV drive manual.
413	DRV SER2 SPD FLT	Drive reporting a SER2 speed fault.	Refer to the HPV drive manual.
414	DRV MOTOR OVRLOAD	Drive reporting a motor overload fault.	Refer to the HPV drive manual.
415	DRV SPD DEV FLT	Drive reporting a speed deviation fault.	Refer to the HPV drive manual.
416	DRV SETUP FLT 9	Drive reporting a setup fault 9.	Refer to the HPV drive manual.
417	DRV SETUP FLT 10	Drive reporting a setup fault 10.	Refer to the HPV drive manual.
418	DRV BRK OPEN FLT	Drive reporting a brake open fault.	Refer to the HPV drive manual.
419	DRV AT CONT FLT	Drive reporting an auto tune contactor fault.	Refer to the HPV drive manual.
420	MAG62	Drive reporting an undefined MAG 62 fault.	Refer to the HPV drive manual.
421	DRV SAFE-OFF OPEN	Drive reporting a safe-off open fault.	Refer to the HPV drive manual.
422	DRV SETUP FLT 11	Drive reporting a setup fault 11.	Refer to the HPV drive manual.
423	DRV QUICKSTART FLT	Drive reporting a quick start fault.	Refer to the HPV drive manual.
424	DRV TACH LOSS	Drive reporting a tach loss fault.	Refer to the HPV drive manual.
425	DRV SETUP FLT 12	Drive reporting a setup fault 12.	Refer to the HPV drive manual.
426	DRV SAFE-OFF SETUP	Drive reporting a safe-off setup fault.	Refer to the HPV drive manual.
427	DRV NTSD SPEED SETUP	Drive reporting an NTSD speed setup fault.	Refer to the HPV drive manual.

Fault Number	Name	Definition	Solution
428	DRV NTSD LI SETUP	Drive reporting an NTSD logical input setup fault.	Refer to the HPV drive manual.
429	MAG71	Drive reporting an undefined MAG 71 fault.	Refer to the HPV drive manual.
430	DRV Encdr PPR FLT	Drive reporting an encoder PPR fault.	Refer to the HPV drive manual.
431	KEB1-OVER VOLT	Drive reporting EOP - Error Over Voltage.	Refer to the KEB drive manual.
432	KEB2-UNDER VOLT	Drive reporting EUP - Error Under Voltage.	Refer to the KEB drive manual.
433	KEB3-INPUT PH. FAIL	Drive reporting EUPh - Error Input Phase Failure.	Refer to the KEB drive manual.
434	KEB4-OVER CURRENT	Drive reporting EOC - Error Over Current.	Refer to the KEB drive manual.
435	KEB5-OUTPUT PH. FAIL	Drive reporting EIPh - Error Output Phase Failure.	Refer to the KEB drive manual.
436	KEB6-OVHT INT	Drive reporting EOHI - Error Overheat Internal.	Refer to the KEB drive manual.
437	KEB7-NO OVHT INT	Drive reporting EnOHI - No Error Overheat Internal.	Refer to the KEB drive manual.
438	KEB8-OVHT PWR MOD	Drive reporting EOH - Error Overheat Power Module.	Refer to the KEB drive manual.
439	KEB9-MTR OVHT	Drive reporting EdOH - Error Motor Overheat.	Refer to the KEB drive manual.
440	KEB10	Drive reporting an undefined KEB10 status.	Refer to the KEB drive manual.
441	KEB11-NO MTR OVHT	Drive reporting EndOH - No Error Motor Overheat.	Refer to the KEB drive manual.
442	KEB12-POWER UNIT	Drive reporting EPU - Error Power Unit.	Refer to the KEB drive manual.
443	KEB13-POW NOT RDY	Drive reporting no_PU - Power Unit Not Ready.	Refer to the KEB drive manual.
444	KEB14	Drive reporting an undefined KEB14 status.	Refer to the KEB drive manual.
445	KEB15-CHARGE RELAY	Drive reporting ELSF - Error Charge Relay Fault.	Refer to the KEB drive manual.
446	KEB16-OVERLOAD	Drive reporting EOL - Error Overload.	Refer to the KEB drive manual.

Fault Number	Name	Definition	Solution
447	KEB17-NO OVERLOAD	Drive reporting EnOL - No Error Overload.	Refer to the KEB drive manual.
448	KEB18-HSP5 SER COM	Drive reporting EbuS - HSP5 Serial Comm.	Refer to the KEB drive manual.
449	KEB19-OVLD LOW SPD	Drive reporting EOL2 - Error Overload Low Speed.	Refer to the KEB drive manual.
450	KEB20-NO OVLD LOW SP	Drive reporting EnOL2 - No Error Overload Low Speed.	Refer to the KEB drive manual.
451	KEB21	Drive reporting an undefined KEB21 status.	Refer to the KEB drive manual.
452	KEB22	Drive reporting an undefined KEB22 status.	Refer to the KEB drive manual.
453	KEB23-BUS SYNC	Drive reporting ESbuS - Error Bus Synchronization.	Refer to the KEB drive manual.
454	KEB24-MAX ACCEL	Drive reporting EACC - Error Maximum Acceleration.	Refer to the KEB drive manual.
455	KEB25-SPD.CTRL LIM	Drive reporting ESCL - Error Speed Control Limit.	Refer to the KEB drive manual.
456	KEB26	Drive reporting an undefined KEB26 status.	Refer to the KEB drive manual.
457	KEB27	Drive reporting an undefined KEB27 status.	Refer to the KEB drive manual.
458	KEB28	Drive reporting an undefined KEB28 status.	Refer to the KEB drive manual.
459	KEB29	Drive reporting an undefined KEB29 status.	Refer to the KEB drive manual.
460	KEB30-MTR PROTECT	Drive reporting EOH2 - Error Motor Protection.	Refer to the KEB drive manual.
461	KEB31-EXTERNAL FLT	Drive reporting EEF - Error External Fault.	Refer to the KEB drive manual.
462	KEB32-ENCODER 1	Drive reporting EEnC1 - Error Encoder 1.	Refer to the KEB drive manual.
463	KEB33	Drive reporting an undefined KEB33 status.	Refer to the KEB drive manual.
464	KEB34-ENCODER 2	Drive reporting EEnC2 - Error Encoder 2.	Refer to the KEB drive manual.

Fault Number	Name	Definition	Solution
465	KEB35-ENCODER	Drive reporting EEnCC - Error Encoder Interface.	Refer to the KEB drive manual.
466	KEB36-NO OVHT POWMOD	Drive reporting EnOH - No Error Overheat Power Module.	Refer to the KEB drive manual.
467	KEB37	Drive reporting an undefined KEB37 status.	Refer to the KEB drive manual.
468	KEB38	Drive reporting an undefined KEB38 status.	Refer to the KEB drive manual.
469	KEB39-ERROR SET	Drive reporting ESEt - Error Set.	Refer to the KEB drive manual.
470	KEB40	Drive reporting an undefined KEB40 status.	Refer to the KEB drive manual.
471	KEB41	Drive reporting an undefined KEB41 status.	Refer to the KEB drive manual.
472	KEB42	Drive reporting an undefined KEB42 status.	Refer to the KEB drive manual.
473	KEB43	Drive reporting an undefined KEB43 status.	Refer to the KEB drive manual.
474	KEB44-SF LIM F	Drive reporting ESLF - Error Software Limit Forward.	Refer to the KEB drive manual.
475	KEB45-SF LIM R	Drive reporting ESLr - Error Software Limit Reverse.	Refer to the KEB drive manual.
476	KEB46-PROT ROTATE F	Drive reporting EPrF - Error Protection Rotation Forward.	Refer to the KEB drive manual.
477	KEB47-PROT ROTATE R	Drive reporting EPrr - Error Protection Rotation Reverse.	Refer to the KEB drive manual.
478	KEB48	Drive reporting an undefined KEB48 status.	Refer to the KEB drive manual.
479	KEB49-PWRCODE INV	Drive reporting EPuci - Error Power Unit Code Invalid.	Refer to the KEB drive manual.
480	KEB50-PWRUNIT CHNG	Drive reporting EPuch - Power Unit Changed.	Refer to the KEB drive manual.
481	KEB51-DRIVER RELAY	Drive reporting Edri - Error Driver Relay.	Refer to the KEB drive manual.
482	KEB52-ENCODER CARD	Drive reporting EHyb - Error Encoder Card.	Refer to the KEB drive manual.

Fault Number	Name	Definition	Solution
483	KEB53-IN ERR DETECT	Drive reporting EiEd - Input Error Detection.	Refer to the KEB drive manual.
484	KEB54-CNTR OVERRUN1	Drive reporting Eco1 - Error Counter Overrun 1.	Refer to the KEB drive manual.
485	KEB55-CNTR OVERRUN2	Drive reporting Eco2 - Error Counter Overrun 2.	Refer to the KEB drive manual.
486	KEB56-LOW MTR CUR	Drive reporting Ebr - Error Low Motor Current.	Refer to the KEB drive manual.
487	KEB57-INIT MFC	Drive reporting Eini - Error Initialization MFC.	Refer to the KEB drive manual.
488	KEB58-OVERSPEED	Drive reporting EOS - Error Overspeed.	Refer to the KEB drive manual.
489	KEB59-CARD CHANGE	Drive reporting EHybC - Error Encoder Card Changed.	Refer to the KEB drive manual.
490	KEB60-CALC MTRDATA	Drive reporting ECdd - Error Calculating Motor Data.	Refer to the KEB drive manual.
491	KEB61	Drive reporting an undefined KEB61 status.	Refer to the KEB drive manual.
492	KEB62	Drive reporting an undefined KEB62 status.	Refer to the KEB drive manual.
493	KEB63	Drive reporting an undefined KEB63 status.	Refer to the KEB drive manual.
494	KEB64-UP ACCEL	Drive reporting Up Acceleration.	Refer to the KEB drive manual.
495	KEB65-UP DECEL	Drive reporting Up Deceleration.	Refer to the KEB drive manual.
496	KEB66-UP CSNT SPD	Drive reporting Up Constant Speed.	Refer to the KEB drive manual.
497	KEB67-DN ACCEL	Drive reporting Down Acceleration.	Refer to the KEB drive manual.
498	KEB68-DN DECEL	Drive reporting Down Deceleration.	Refer to the KEB drive manual.
499	KEB69-DN CST SPD	Drive reporting Down Constant Speed.	Refer to the KEB drive manual.
500	KEB70-NO DIRECTION	Drive reporting No Direction Selected.	Refer to the KEB drive manual.
501	KEB71-STALL	Drive reporting Stall.	Refer to the KEB drive manual.
502	KEB72-LA STOP	Drive reporting LA Stop.	Refer to the KEB drive manual.
503	KEB73-LD STOP	Drive reporting Ld Stop.	Refer to the KEB drive manual.

Fault Number	Name	Definition	Solution
504	KEB74-SPD SRCH	Drive reporting Speed Search.	Refer to the KEB drive manual.
505	KEB75-DC BRAKE	Drive reporting DC Brake.	Refer to the KEB drive manual.
506	KEB76-BASE BLCK	Drive reporting Base Block.	Refer to the KEB drive manual.
507	KEB77-LOW SPD	Drive reporting Low Speed / DC Brake.	Refer to the KEB drive manual.
508	KEB78-PWR OFF	Drive reporting Power Off.	Refer to the KEB drive manual.
509	KEB79-QUICK STOP	Drive reporting Quick Stop.	Refer to the KEB drive manual.
510	KEB80-HW CUR LIMIT	Drive reporting Hardware Current Limit.	Refer to the KEB drive manual.
511	KEB81-ACTIVE REF	Drive reporting Search for Reference Active.	Refer to the KEB drive manual.
512	KEB82-CALC MTRDATA	Drive reporting Calculate Motor Data.	Refer to the KEB drive manual.
513	KEB83-POSITIONING	Drive reporting Positioning.	Refer to the KEB drive manual.
514	KEB84-LOW SPD/POW	Drive reporting Low Speed / Power Off.	Refer to the KEB drive manual.
515	KEB85-CLOSING BRK	Drive reporting Closing Brake.	Refer to the KEB drive manual.
516	KEB86-OPENING BRK	Drive reporting Opening Brake.	Refer to the KEB drive manual.
517	KEB87-STOP OVHEAT	Drive reporting Abnormal Stop Overheat Interior.	Refer to the KEB drive manual.
518	KEB88-NO OVHT POW	Drive reporting No Alarm Overheat Power Module.	Refer to the KEB drive manual.
519	KEB89-STOP OVHT POW	Drive reporting Abnormal Stop Overheat Power Module.	Refer to the KEB drive manual.
520	KEB90-STOP EXT FLT	Drive reporting Abnormal Stop External Fault.	Refer to the KEB drive manual.
521	KEB91-NO DRV OVH	Drive reporting No Alarm Drive Overheat.	Refer to the KEB drive manual.
522	KEB92-NO STP OVH IN	Drive reporting No Alarm Stop Overheat Interior.	Refer to the KEB drive manual.
523	KEB93-STOP BUS	Drive reporting Abnormal Stop Bus.	Refer to the KEB drive manual.
524	KEB94-STOP PROT F	Drive reporting Abnormal Stop Protection Rotation Forward.	Refer to the KEB drive manual.

Fault Number	Name	Definition	Solution
525	KEB95-STOP PROT R	Drive reporting Abnormal Stop Protection Rotation Reverse.	Refer to the KEB drive manual.
526	KEB96-STOP DRVE OVH	Drive reporting Abnormal Stop Drive Overheat.	Refer to the KEB drive manual.
527	KEB97-STOP MTR PRCT	Drive reporting Abnormal Stop Motor Protection.	Refer to the KEB drive manual.
528	KEB98-NO STEP OL	Drive reporting No Abnormal Stop Overload.	Refer to the KEB drive manual.
529	KEB99-STOP OVL	Drive reporting Abnormal Stop Overload.	Refer to the KEB drive manual.
530	KEB100-STOP OVL2	Drive reporting Abnormal Stop Overload 2.	Refer to the KEB drive manual.
531	KEB101- NO STOP OVL2	Drive reporting No Abnormal Stop Overload 2.	Refer to the KEB drive manual.
532	KEB102-STOP SET	Drive reporting Abnormal Stop Set.	Refer to the KEB drive manual.
533	KEB103-STOP BUS SYNC	Drive reporting Abnormal Stop Bus Synchronization.	Refer to the KEB drive manual.
534	KEB104-SF LIM FWD	Drive reporting Abnormal Stop Software Limit Forward.	Refer to the KEB drive manual.
535	KEB105-SF LIM RVSE	Drive reporting Abnormal Stop Software Limit Reverse.	Refer to the KEB drive manual.
536	KEB106-STOP MAX ACC	Drive reporting Abnormal Stop Maximum Acceleration.	Refer to the KEB drive manual.
537	KEB107-STOP SPD LIM	Drive reporting Abnormal Stop Speed Control Limit.	Refer to the KEB drive manual.
538	KEB108	Drive reporting an undefined KEB108 status.	Refer to the KEB drive manual.
539	KEB109	Drive reporting an undefined KEB109 status.	Refer to the KEB drive manual.
540	KEB110	Drive reporting an undefined KEB110 status.	Refer to the KEB drive manual.

Fault Number	Name	Definition	Solution
541	KEB111	Drive reporting an undefined KEB111 status.	Refer to the KEB drive manual.
542	KEB112	Drive reporting an undefined KEB112 status.	Refer to the KEB drive manual.
543	KEB113	Drive reporting an undefined KEB113 status.	Refer to the KEB drive manual.
544	KEB114	Drive reporting an undefined KEB114 status.	Refer to the KEB drive manual.
545	KEB115	Drive reporting an undefined KEB115 status.	Refer to the KEB drive manual.
546	KEB116	Drive reporting an undefined KEB116 status.	Refer to the KEB drive manual.
547	KEB117	Drive reporting an undefined KEB117 status.	Refer to the KEB drive manual.
548	KEB118	Drive reporting an undefined KEB118 status.	Refer to the KEB drive manual.
549	KEB119	Drive reporting an undefined KEB119 status.	Refer to the KEB drive manual.
550	KEB120	Drive reporting an undefined KEB120 status.	Refer to the KEB drive manual.
551	KEB121-READY POS	Drive reporting Ready for Positioning.	Refer to the KEB drive manual.
552	KEB122-POS ACTIVE	Drive reporting Positioning Active.	Refer to the KEB drive manual.
553	KEB123-POS. NOT ACC	Drive reporting Position Not Accessible.	Refer to the KEB drive manual.
554	KEB124-PROT R.FWD	Drive reporting Protection Rotation Forward.	Refer to the KEB drive manual.
555	KEB125-PROT R.REV	Drive reporting Protection Rotation Reverse.	Refer to the KEB drive manual.
556	KEB126-POS NOT ACC	Drive reporting Position Not Accessible Ignored.	Refer to the KEB drive manual.

Fault Number	Name	Definition	Solution
557	KEB127-CALC CMLTE	Drive reporting Calculate Motor Data Complete.	Refer to the KEB drive manual.
558	KEB128-REF FOUND	Drive reporting Reference Found.	Refer to the KEB drive manual.
559	KEB129	Drive reporting an undefined KEB129 status.	Refer to the KEB drive manual.
560	KEB130	Drive reporting an undefined KEB130 status.	Refer to the KEB drive manual.
561	KEB131	Drive reporting an undefined KEB131 status.	Refer to the KEB drive manual.
562	KEB132	Drive reporting an undefined KEB132 status.	Refer to the KEB drive manual.
563	KEB133	Drive reporting an undefined KEB133 status.	Refer to the KEB drive manual.
564	KEB134	Drive reporting an undefined KEB134 status.	Refer to the KEB drive manual.
565	KEB135	Drive reporting an undefined KEB135 status.	Refer to the KEB drive manual.
566	KEB136	Drive reporting an undefined KEB136 status.	Refer to the KEB drive manual.
567	KEB137	Drive reporting an undefined KEB137 status.	Refer to the KEB drive manual.
568	KEB138	Drive reporting an undefined KEB138 status.	Refer to the KEB drive manual.
569	KEB139	Drive reporting an undefined KEB139 status.	Refer to the KEB drive manual.
570	KEB140	Drive reporting an undefined KEB140 status.	Refer to the KEB drive manual.

Fault Number	Name	Definition	Solution
571	KEB141	Drive reporting an undefined KEB141 status.	Refer to the KEB drive manual.
572	KEB142	Drive reporting an undefined KEB142 status.	Refer to the KEB drive manual.
573	KEB143	Drive reporting an undefined KEB143 status.	Refer to the KEB drive manual.
574	KEB144	Drive reporting an undefined KEB144 status.	Refer to the KEB drive manual.
575	KEB145	Drive reporting an undefined KEB145 status.	Refer to the KEB drive manual.
576	KEB146	Drive reporting an undefined KEB146 status.	Refer to the KEB drive manual.
577	KEB147	Drive reporting an undefined KEB147 status.	Refer to the KEB drive manual.
578	KEB148	Drive reporting an undefined KEB148 status.	Refer to the KEB drive manual.
579	KEB149	Drive reporting an undefined KEB149 status.	Refer to the KEB drive manual.
580	KEB150-M.CONT FAIL	Drive reporting Main Contact Failure.	Refer to the KEB drive manual.
581	KEB151-BRK SW FAIL	Drive reporting Brake Switch Failure.	Refer to the KEB drive manual.
582	KEB152-SPD FOLLOW	Drive reporting Speed Following Error.	Refer to the KEB drive manual.
583	KEB153-SPD SELECT	Drive reporting Speed Selection Error.	Refer to the KEB drive manual.
584	KEB154-ETS IN. FAIL	Drive reporting ETS Input Failure.	Refer to the KEB drive manual.
585	KEB155-ETS OVRSPD	Drive reporting ETS Overspeed.	Refer to the KEB drive manual.
586	KEB156-NTS IN. FAIL	Drive reporting NTS Input Failure.	Refer to the KEB drive manual.

Fault Number	Name	Definition	Solution
587	KEB157-SIGNAL FAIL	Drive reporting Analog Signal Failure.	Refer to the KEB drive manual.
588	KEB158-UNIN. MVMT	Drive reporting Unintended Movement.	Refer to the KEB drive manual.
589	KEB159-SC FLT RST	Drive reporting Secure Fault Reset.	Refer to the KEB drive manual.
590	KEB160-ESD IN. FAIL	Drive reporting ESD Input Failure.	Refer to the KEB drive manual.
591	KEB161-DIR SEL FAIL	Drive reporting Direction Selection Failure.	Refer to the KEB drive manual.
592	KEB162-DRV EN SW OFF	Drive reporting Drive Enabled Switched Off.	Refer to the KEB drive manual.
593	KEB163-FIELD BUS WD	Drive reporting Error Field Bus Watchdog.	Refer to the KEB drive manual.
594	KEB164-COM POS	Drive reporting Error Commutation Position.	Refer to the KEB drive manual.
595	KEB165-EXCESS ACL	Drive reporting Error Excessive Acceleration.	Refer to the KEB drive manual.
596	KEB166-SER.CMD.SPD	Drive reporting Error Serial Command Speed.	Refer to the KEB drive manual.
597	KEB167	Drive reporting an undefined KEB167 status.	Refer to the KEB drive manual.
598	KEB168	Drive reporting an undefined KEB168 status.	Refer to the KEB drive manual.
599	KEB169	Drive reporting an undefined KEB169 status.	Refer to the KEB drive manual.
600	KEB170-UPS MODE	Drive reporting UPS Mode.	Refer to the KEB drive manual.
601	KEB171-REDUCE TRQ	Drive reporting Reduced Torque.	Refer to the KEB drive manual.
602	KEB172-EPOW PROF	Drive reporting Emergency Profile.	Refer to the KEB drive manual.
603	KEB173-EPOW GEN SPD	Drive reporting Emergency Generator Speed.	Refer to the KEB drive manual.
604	KEB174-EQ SPEED	Drive reporting Earthquake Speed.	Refer to the KEB drive manual.
605	KEB175-EMG SLOWDOWN	Drive reporting Emergency Slowdown.	Refer to the KEB drive manual.

Fault Number	Name	Definition	Solution
606	KEB176	Drive reporting an undefined KEB176 status.	Refer to the KEB drive manual.
607	KEB177	Drive reporting an undefined KEB177 status.	Refer to the KEB drive manual.
608	KEB178	Drive reporting an undefined KEB178 status.	Refer to the KEB drive manual.
609	KEB179	Drive reporting an undefined KEB179 status.	Refer to the KEB drive manual.
610	KEB180	Drive reporting an undefined KEB180 status.	Refer to the KEB drive manual.
611	KEB181	Drive reporting an undefined KEB181 status.	Refer to the KEB drive manual.
612	KEB182	Drive reporting an undefined KEB182 status.	Refer to the KEB drive manual.
613	KEB183	Drive reporting an undefined KEB183 status.	Refer to the KEB drive manual.
614	KEB184	Drive reporting an undefined KEB184 status.	Refer to the KEB drive manual.
615	KEB185	Drive reporting an undefined KEB185 status.	Refer to the KEB drive manual.
616	KEB186	Drive reporting an undefined KEB186 status.	Refer to the KEB drive manual.
617	KEB187	Drive reporting an undefined KEB187 status.	Refer to the KEB drive manual.
618	KEB188	Drive reporting an undefined KEB188 status.	Refer to the KEB drive manual.
619	KEB189	Drive reporting an undefined KEB189 status.	Refer to the KEB drive manual.

Fault Number	Name	Definition	Solution
620	KEB190	Drive reporting an undefined KEB190 status.	Refer to the KEB drive manual.
621	KEB191	Drive reporting an undefined KEB191 status.	Refer to the KEB drive manual.
622	KEB192	Drive reporting an undefined KEB192 status.	Refer to the KEB drive manual.
623	KEB193	Drive reporting an undefined KEB193 status.	Refer to the KEB drive manual.
624	KEB194	Drive reporting an undefined KEB194 status.	Refer to the KEB drive manual.
625	KEB195	Drive reporting an undefined KEB195 status.	Refer to the KEB drive manual.
626	KEB196	Drive reporting an undefined KEB196 status.	Refer to the KEB drive manual.
627	KEB197	Drive reporting an undefined KEB197 status.	Refer to the KEB drive manual.
628	KEB198	Drive reporting an undefined KEB198 status.	Refer to the KEB drive manual.
629	KEB199	Drive reporting an undefined KEB199 status.	Refer to the KEB drive manual.
630	KEB200-NO COM E.CARD	Drive reporting No Communication to Encoder Card.	Refer to the KEB drive manual.
631	KEB201-E.CARD COM OK	Drive reporting Encoder Communication OK.	Refer to the KEB drive manual.
632	KEB202-ENCODER UNDEF	Drive reporting Encoder Not Defined.	Refer to the KEB drive manual.
633	KEB203	Drive reporting an undefined KEB203 status.	Refer to the KEB drive manual.

Fault Number	Name	Definition	Solution
634	KEB204	Drive reporting an undefined KEB204 status.	Refer to the KEB drive manual.
635	KEB205	Drive reporting an undefined KEB205 status.	Refer to the KEB drive manual.
636	KEB206-NO COM TO ENC	Drive reporting No Communication to Encoder.	Refer to the KEB drive manual.
637	KEB207-INC COUNT DEV	Drive reporting Incremental Count Deviation.	Refer to the KEB drive manual.
638	KEB208-EN.PPR LE01	Drive reporting Encoder PPR does not match LE01.	Refer to the KEB drive manual.
639	KEB209-ID WRONG	Drive reporting Interface ID is wrong.	Refer to the KEB drive manual.
640	KEB210	Drive reporting an undefined KEB210 status.	Refer to the KEB drive manual.
641	KEB211	Drive reporting an undefined KEB211 status.	Refer to the KEB drive manual.
642	KEB212	Drive reporting an undefined KEB212 status.	Refer to the KEB drive manual.
643	KEB213-ENC. OVHT	Drive reporting Encoder Overtemperature.	Refer to the KEB drive manual.
644	KEB214-ENC. OVRSPD	Drive reporting Encoder Overspeed.	Refer to the KEB drive manual.
645	KEB215-ENC. LOW VOLT	Drive reporting Encoder Supply Voltage Too Low.	Refer to the KEB drive manual.
646	KEB216-INTERNAL ENC.	Drive reporting Internal Encoder Error.	Refer to the KEB drive manual.
647	KEB217-ENC.FRMATING	Drive reporting Formatting Encoder.	Refer to the KEB drive manual.
648	KEB218	Drive reporting an undefined KEB218 status.	Refer to the KEB drive manual.
649	KEB219	Drive reporting an undefined KEB219 status.	Refer to the KEB drive manual.

Fault Number	Name	Definition	Solution
650	KEB220	Drive reporting an undefined KEB220 status.	Refer to the KEB drive manual.
651	KEB221-NEW ENC.	Drive reporting New Encoder Identified.	Refer to the KEB drive manual.
652	KEB222-UNDEF ENC.	Drive reporting Undefined Encoder Error.	Refer to the KEB drive manual.
653	KEB223-ENC.IN BSY	Drive reporting Encoder Interface Busy	Refer to the KEB drive manual.
655	Payment Passcode	Enter payment passcode under SETUP MISC PAYMENT PASSCODE.	Submit payment and receive payment passcode from Smartrise Engineering.
713	FAULT INPUT	Discrete fault input has been high for 200ms.	Check IO configuration & wiring.
714	Drive Fault (UNK)	Drive reporting a fault that is out of the C4 system's defined range.	Check the drive fault log. Note, for KEB this signals that the drive ready output is either low or the output is misconfigured on the drive.
715	FRAM Data Corrupt	FRAM data redundancy check has failed and data was not recovered.	Contact support.
716	Max Runs Per Minute	Car exceeding max number of runs per minute.	Check that car is not repeatedly releveling for a floor.
717	Need To Cycle Pwr CT	A system configuration parameter was changed. The system must be power cycled.	Cycle power to the system.
718	Need To Cycle Pwr COP	A system configuration parameter was changed. The system must be power cycled.	Cycle power to the system.
807	EQ	Seismic input is high	Check the Seismic input
837	Valve Unk	Primary primary valve board reporting an unknown fault.	Check primary valve board and wiring.
838	Valve POR Rst	Primary primary valve board recovering from a reset due to power off.	Check primary valve board and wiring.
839	Valve WDT Rst	Primary primary valve board recovering from reset due to watchdog.	Check primary valve board and wiring.

Fault Number	Name	Definition	Solution
840	Valve BOD Rst	Primary primary valve board recovering from reset due to voltage dip.	Check primary valve board and wiring.
841	Valve Comm Loss	Primary primary valve board reporting loss of communication with elevator controller.	Check primary valve board and wiring.
842	Valve Level Dn	Primary primary valve board reporting mismatch between valve control and status signals of level speed down output.	Replace primary valve board
843	Valve Level Up	Primary primary valve board reporting mismatch between valve control and status signals of level speed up output.	Replace primary valve board
844	Valve High Dn	Primary primary valve board reporting mismatch between valve control and status signals of high speed down output.	Replace primary valve board
845	Valve High Up	Primary primary valve board reporting mismatch between valve control and status signals of high speed up output.	Replace primary valve board
846	Valve SM	Primary primary valve board reporting mismatch between control and status signals of the start motor output.	Replace primary valve board
847	Valve Inv. Cmd.	Primary primary valve board reporting both up and down commands issued at the same time.	Check primary valve board and wiring.
848	Valve CAN Bus Rst	Primary primary valve board reporting a CAN bus reset.	Check primary valve board and wiring.

Fault Number	Name	Definition	Solution
849	SS Unk	Primary soft starter reporting an unknown fault.	(Hydro Only) Check primary soft starter board and wiring.
850	SS POR Rst	Primary soft starter recovering from a reset due to power off.	(Hydro Only) Check primary soft starter board and wiring.
851	SS WDT Rst	Primary soft starter recovering from reset due to watchdog.	(Hydro Only) Check primary soft starter board and wiring.
852	SS BOD Rst	Primary soft starter recovering from reset due to voltage dip.	(Hydro Only) Check primary soft starter board and wiring.
853	SS Comm Loss	Primary soft starter reporting loss of communication with the elevator controller.	(Hydro Only) Check primary soft starter board and wiring.
854	SS OC	Primary soft starter reporting an overcurrent error.	(Hydro Only) Check primary soft starter board and wiring.
855	SS OVV	Primary soft starter reporting an overvoltage error.	(Hydro Only) Check primary soft starter board and wiring.
856	SS UNDV	Primary soft starter reporting an undervoltage error.	(Hydro Only) Check primary soft starter board and wiring.
857	SS Phase Miss	Primary soft starter reporting a missing phase.	(Hydro Only) Check primary soft starter board and wiring.
858	SS Phase Seq	Primary soft starter reporting phase sequence error.	(Hydro Only) Check primary soft starter board and wiring.
859	SS CAN Bus Rst	Primary soft starter reporting a CAN bus reset.	(Hydro Only) Check primary soft starter board and wiring.
860	Valve Offline	Communication lost with primary valve board.	Check primary valve board and wiring.
861	SS Offline	Communication lost with primary soft starter.	Check primary soft starter board and wiring.
862	Motor Overheat	The Motor Overheat input has been triggered. The motor is overheated.	Check the Motor Overheat input. Check the state of the motor.

Fault Number	Name	Definition	Solution
863	Valve2 Unk	Secondary valve board reporting an unknown fault.	Check secondary valve board and wiring.
864	Valve2 POR Rst	Secondary valve board recovering from a reset due to power off.	Check secondary valve board and wiring.
865	Valve2 WDT Rst	Secondary valve board recovering from reset due to watchdog.	Check secondary valve board and wiring.
866	Valve2 BOD Rst	Secondary valve board recovering from reset due to voltage dip.	Check secondary valve board and wiring.
867	Valve2 Comm Loss	Secondary valve board reporting loss of communication with elevator controller.	Check secondary valve board and wiring.
868	Valve2 Level Dn	Secondary valve board reporting mismatch between valve control and status signals of level speed down output.	Replace secondary valve board
869	Valve2 Level Up	Secondary valve board reporting mismatch between valve control and status signals of level speed up output.	Replace secondary valve board
870	Valve2 High Dn	Secondary valve board reporting mismatch between valve control and status signals of high speed down output.	Replace secondary valve board
871	Valve2 High Up	Secondary valve board reporting mismatch between valve control and status signals of high speed up output.	Replace secondary valve board
872	Valve2 SM	Secondary valve board reporting mismatch between control and status signals of the start motor output.	Replace secondary valve board

Fault Number	Name	Definition	Solution
873	Valve2 Inv. Cmd.	Secondary valve board reporting both up and down commands issued at the same time.	Check secondary valve board and wiring.
874	Valve2 CAN Bus Rst	Secondary valve board reporting a CAN bus reset.	Check secondary valve board and wiring.
875	Valve2 Offline	Communication lost with secondary valve board.	Check secondary valve board and wiring.
876	Valve Dupl. Addr.	Two primary valve boards detected on the network.	Check valve board addressing.
877	Valve2 Dupl. Addr.	Two secondary valve boards detected on the network.	Check valve board addressing.
880	Low Oil	Low Oil input is active suggesting oil levels are low.	(Hydro Only) Check oil levels, Low Oil Input, then reset the latching fault via the reset button.
882	Low Pressure	Low Pressure input is active suggesting there is low pressure.	(Hydro Only) Check Pump Low Pressure Sensor, Check Low Pressure input.
883	Low Oil MLT	Car pump motor stayed consistently ON during one run and exceeded the run time limit.	(Hydro Only) Check pump Oil levels
884	SS2 Offline	Communication lost with secondary soft starter.	(Hydro Only) Check secondary soft starter board and wiring.
885	SS2 Unk	Secondary soft starter reporting an unknown fault.	(Hydro Only) Check secondary soft starter board and wiring.
886	SS2 POR Rst	Secondary soft starter recovering from a reset due to power off.	(Hydro Only) Check secondary soft starter board and wiring.
887	SS2 WDT Rst	Secondary soft starter recovering from reset due to watchdog.	(Hydro Only) Check secondary soft starter board and wiring.
888	SS2 BOD Rst	Secondary soft starter recovering from reset due to voltage dip.	(Hydro Only) Check secondary soft starter board and wiring.
889	SS2 Comm Loss	Secondary soft starter reporting loss of communication with the elevator controller.	(Hydro Only) Check secondary soft starter board and wiring.

Fault Number	Name	Definition	Solution
890	SS2 OC	Secondary soft starter reporting an overcurrent error.	(Hydro Only) Check secondary soft starter board and wiring.
891	SS2 OVV	Secondary soft starter reporting an overvoltage error.	(Hydro Only) Check secondary soft starter board and wiring.
892	SS2 UNDV	Secondary soft starter reporting an undervoltage error.	(Hydro Only) Check secondary soft starter board and wiring.
893	SS2 Phase Miss	Secondary soft starter reporting a missing phase.	(Hydro Only) Check secondary soft starter board and wiring.
894	SS2 Phase Seq	Secondary soft starter reporting phase sequence error.	(Hydro Only) Check secondary soft starter board and wiring.
895	SS2 CAN Bus Rst	Secondary soft starter reporting a CAN bus reset.	(Hydro Only) Check secondary soft starter board and wiring.
896	Viscosity Max Cycles	Viscosity Operation reached its maximum number of cycles	(Hydro Only) Check Viscosity sensor and input, then reset the latching fault via Dip A1.
897	SS Input Flt	Discrete input fault 1 from the Soft Starter has been activated	(Hydro Only) Check the SS Input fault and the contact feeding the input from the drive.
898	SS2 Input Flt	Discrete input fault 2 from the Soft Starter has been activated.	(Hydro Only) Check the SS 2 Input fault, and the contact feeding the input from the drive.
899	Phase Flt	Line monitoring hardware has detected voltage lines are out of phase or missing. Only checked if programmed.	(Hydro Only) Check line monitoring hardware and wiring.
902	SS ADDR	Primary soft starter reporting another board on the network has the same address.	(Hydro Only) Check primary soft starter address DIP switches.
903	SS2 ADDR	Secondary soft starter reporting another board on the network has the same address.	(Hydro Only) Check secondary soft starter address DIP switches.
904	UPH Valve MON	(Hydro Only) Monitoring of safety relay for cutting	Check the wiring of the UPH VALVE MON input.

Fault Number	Name	Definition	Solution
		the up high valve's neutral side showing an invalid state. Valid only for bucher and blain valve type configurations.	
905	DNH Valve MON	(Hydro Only) Monitoring of safety relay for cutting the down high valve's neutral side showing an invalid state. Valid only for bucher and blain valve type configurations.	Check the wiring of the DNH VALVE MON input.
906	INSP Valve MON	(Hydro Only) Monitoring of safety relay for cutting the inspection valve's neutral side showing an invalid state. Valid only for bucher and blain valve type configurations.	Check the wiring of the INSP VALVE MON input.
908	OOS Consecutive	Car has flagged the same fault 3 times in a row and has been taken out of service.	This fault does not auto clear. Controller must be power cycled to clear this state.
909	OOS Hourly	The car has flagged more than X faults within an hour and the car has been taken out of service. This hour is not aligned with the real time clock. This OOS state will auto reset after the hour passes. X is HourlyFaultLimit (08-160).	Investigate the faults logged within an hour of this fault. Reset the controller or move to inspection to clear the fault immediately, otherwise this fault auto clears after an hour.
910	OOS Door	The car has flagged more than X door faults within an hour and the car has been taken out of service. This hour is not aligned with the real time clock. This OOS state will auto reset after the hour	Investigate the door faults logged within an hour of this fault. Reset the controller or move to inspection to clear the fault immediately, otherwise this fault auto clears after an hour.

Fault Number	Name	Definition	Solution
		passes. X is DoorHourlyFaultLimit (08-148).	
911	OOS Max Starts	The car has attempted to run more than X times within a minute. This minute is not aligned with the real time clock. This OOS state will auto reset after the minute passes. X is MaxStartsPerMinute (08-196).	Check if the car is repeatedly correcting or releveling trying to make floor level. Check if the car is repeatedly trying and failing to start a run. Reset the controller or move to inspection to clear the fault immediately. Otherwise, the fault auto clears after 1 minute.
912	OOS Key switch	The car has been taken out of service by the OOS key switch input.	Check the status of the OOS key switch input.
913	OOS DL20	The car has been taken out of service by the DL20 fixture.	Check the fault status of the DL20 fixture.
914	Delta Stuck Active	The Delta relay's feedback signal shows the relay is active, when the Delta output driving the relay is inactive. Valid for hydro controllers with wye delta style starters.	(Hydro Only) Check the status of the delta relay.
915	Delta Stuck Inactive	The Delta relay's feedback signal shows the relay is inactive, when the Delta output driving the relay is active. Valid for hydro controllers with wye delta style starters.	(Hydro Only) Check the status of the delta relay.
916	Starter Overload	Starter overload relay used for contactor-based starters is active.	(Hydro Only) Check the status of the starter overload relay.
918	Can't Run Up	If Low Oil, MLT, or Motor Overheat is active in the background, the controller is prevented from running up in all modes of operation.	(Hydro Only) Verify that Low Oil, MLT, or Motor Overheat is not active. Clear them via Dip A1 reset.

Fault Number	Name	Definition	Solution
919	Inv. Run Dist.	The car has moved since its original destination assessment. The new destination request is no longer achievable.	Depending on the amount of movement that occurs when the run drops, and the car's configured SETUP SCURVE DEST. OFFSET UP, DEST. OFFSET DOWN, RELEVEL OFFSET UP, RELEVEL OFFSET DOWN, the car may not be able to make the requested run. Reducing the amount of car movement at the end of run will reduce the likelihood of this occurring.
920	ENDAT FAULT	Drive is reporting an Endat fault.	Refer to the Quattro drive manual.
921	OLA ENDT FLT	Drive is reporting an OLA ENDT FLT	Refer to the Quattro drive manual.
922	OLA ENC FLT	Drive is reporting an OLA ENC FLT	Refer to the Quattro drive manual.
923	SETUP FAULT 9	Drive is reporting a SETUP FAULT 9	Refer to the Quattro drive manual.
924	QUATTRO FLT 49	Drive is reporting an undefined fault 49	Refer to the Quattro drive manual.
925	QUATTRO FLT 50	Drive is reporting an undefined fault 50	Refer to the Quattro drive manual.
926	HW/SW MISMATCH	Drive is reporting an HW/SW MISMATCH	Refer to the Quattro drive manual.
927	QUATTRO FLT 52	Drive is reporting an undefined fault 52	Refer to the Quattro drive manual.
928	MSPD TMR FLT	Drive is reporting an MSPD TMR FLT	Refer to the Quattro drive manual.
929	QUATTRO FLT 54	Drive is reporting an undefined fault 54	Refer to the Quattro drive manual.
930	SER2 SPD FLT	Drive is reporting an SER2 SPD FLT	Refer to the Quattro drive manual.
931	MTR OVERLD FLT	Drive is reporting an MTR OVERLD FLT	Refer to the Quattro drive manual.
932	FIELD LOSS	Drive is reporting a FIELD LOSS	Refer to the Quattro drive manual.
933	MODULE A IGBT	Drive is reporting a MODULE A IGBT	Refer to the Quattro drive manual.
934	MODULE B IGBT	Drive is reporting a MODULE B IGBT	Refer to the Quattro drive manual.

Fault Number	Name	Definition	Solution
935	OPEN ARMATURE	Drive is reporting an OPEN ARMATURE	Refer to the Quattro drive manual.
936	MODULE C IGBT	Drive is reporting a MODULE C IGBT	Refer to the Quattro drive manual.
937	LS TEMP FLT	Drive is reporting an LS TEMP FLT	Refer to the Quattro drive manual.
938	SFT CN OPENED	Drive is reporting an SFT CN OPENED	Refer to the Quattro drive manual.
939	SFT CN NOT CL	Drive is reporting an SFT CN NOT CL	Refer to the Quattro drive manual.
940	QUATTRO FLT 65	Drive is reporting an undefined fault 65	Refer to the Quattro drive manual.
941	QUATTRO FLT 66	Drive is reporting an undefined fault 66	Refer to the Quattro drive manual.
942	QUATTRO FLT 67	Drive is reporting an undefined fault 67	Refer to the Quattro drive manual.
943	CHECK SETUP	Drive is reporting a CHECK SETUP	Refer to the Quattro drive manual.
944	REVERSE TACH	Drive is reporting a REVERSE TACH	Refer to the Quattro drive manual.
945	IP COMM	Drive is reporting an IP COMM	Refer to the Quattro drive manual.
946	MS-LS MISMTCH	Drive is reporting an MS-LS MISMTCH	Refer to the Quattro drive manual.
947	MONITOR REV	Drive is reporting a MONITOR REV	Refer to the Quattro drive manual.
948	UTIL DATA SUM	Drive is reporting UTIL DATA SUM	Refer to the Quattro drive manual.
949	QUATTRO FLT 74	Drive is reporting an undefined fault 74	Refer to the Quattro drive manual.
950	QUATTRO FLT 75	Drive is reporting an undefined fault 75	Refer to the Quattro drive manual.
951	QUATTRO FLT 76	Drive is reporting an undefined fault 76	Refer to the Quattro drive manual.
952	QUATTRO FLT 77	Drive is reporting an undefined fault 77	Refer to the Quattro drive manual.
953	QUATTRO FLT 78	Drive is reporting an undefined fault 78	Refer to the Quattro drive manual.
954	MS SIZE	Drive is reporting a MS SIZE	Refer to the Quattro drive manual.
955	QUATTRO FLT 80	Drive is reporting an undefined fault 80	Refer to the Quattro drive manual.

Fault Number	Name	Definition	Solution
956	POWER ON	Drive is reporting a POWER ON	Refer to the Quattro drive manual.
957	FLD PWM SET HI	Drive is reporting a FLD PWM SET HI	Refer to the Quattro drive manual.
958	QUATTRO FLT 83	Drive is reporting an undefined fault 83	Refer to the Quattro drive manual.
959	QUATTRO FLT 84	Drive is reporting an undefined fault 84	Refer to the Quattro drive manual.
960	GATE PWR ENA	Drive is reporting a GATE PWR ENA	Refer to the Quattro drive manual.
961	GATE ALARM	Drive is reporting a GATE ALARM	Refer to the Quattro drive manual.
962	QUATTRO FLT 87	Drive is reporting an undefined fault 87	Refer to the Quattro drive manual.
963	QUATTRO FLT 88	Drive is reporting an undefined fault 88	Refer to the Quattro drive manual.
964	QUATTRO FLT 89	Drive is reporting an undefined fault 89	Refer to the Quattro drive manual.
965	NTSD LOGIC IN	Drive is reporting a NTSD LOGIC IN	Refer to the Quattro drive manual.
966	NTSD SPEED	Drive is reporting a NTSD SPEED	Refer to the Quattro drive manual.
967	TORQ LIM 2HI FLT	Drive is reporting a TORQ LIM 2HI FLT	Refer to the Quattro drive manual.
968	CONNECTOR OFF	Drive is reporting a CONNECTOR OFF	Refer to the Quattro drive manual.
969	QUATTRO FLT 94	Drive is reporting an undefined fault 94	Refer to the Quattro drive manual.
970	QUATTRO FLT 95	Drive is reporting an undefined fault 95	Refer to the Quattro drive manual.
971	SPD DEV	Drive is reporting an SPD DEV	Refer to the Quattro drive manual.
972	NO OPTION CRD	Drive is reporting a NO OPTION CRD	Refer to the Quattro drive manual.
973	BRAKE IS OPEN	Drive is reporting a BRAKE IS OPEN	Refer to the Quattro drive manual.
974	AT CNTACTR FLT	Drive is reporting an AT CNTACTR FLT	Refer to the Quattro drive manual.
975	LS PHASE	Drive is reporting a LS PHASE	Refer to the Quattro drive manual.
976	LS CURR REG	Drive is reporting a LS CURR REG	Refer to the Quattro drive manual.

Fault Number	Name	Definition	Solution
977	LS OVERVOLT	Drive is reporting a LS OVERVOLT	Refer to the Quattro drive manual.
978	LS UNDRVOLT	Drive is reporting a LS UNDRVOLT	Refer to the Quattro drive manual.
979	LS CHARGE	Drive is reporting a LS CHARGE	Refer to the Quattro drive manual.
980	LS OVERLOAD	Drive is reporting a LS OVERLOAD	Refer to the Quattro drive manual.
981	LS CUBE ID	Drive is reporting a LS CUBE ID	Refer to the Quattro drive manual.
982	LS DCU DATA	Drive is reporting a LS DCU DATA	Refer to the Quattro drive manual.
983	LS CUBE DATA	Drive is reporting a LS CUBE DATA	Refer to the Quattro drive manual.
984	LS PCU DATA	Drive is reporting a LS PCU DATA	Refer to the Quattro drive manual.
985	QUATTRO FLT 110	Drive is reporting an undefined fault 110	Refer to the Quattro drive manual.
986	LS OVERTEMP	Drive is reporting a LS OVERTEMP	Refer to the Quattro drive manual.
987	LS BRDG GND	Drive is reporting a LS BRDG GND	Refer to the Quattro drive manual.
988	LS OVERCURRE	Drive is reporting a LS OVERCURRE	Refer to the Quattro drive manual.
989	LS CONN OFF	Drive is reporting a LS CONN OFF	Refer to the Quattro drive manual.
990	LS IP COMM	Drive is reporting a LS IP COMM	Refer to the Quattro drive manual.
991	LS HW/SW	Drive is reporting a LS HW/SW	Refer to the Quattro drive manual.
992	LS IGBT 1	Drive is reporting a LS IGBT 1	Refer to the Quattro drive manual.
993	LS IGBT 2	Drive is reporting a LS IGBT 2	Refer to the Quattro drive manual.
994	LS IGBT 3	Drive is reporting a LS IGBT 3	Refer to the Quattro drive manual.
995	LS AC CNTCR	Drive is reporting a LS AC CNTCR	Refer to the Quattro drive manual.
996	LS CHK SETUP	Drive is reporting a LS CHK SETUP	Refer to the Quattro drive manual.
997	LINE HI VOLTS	Drive is reporting a LINE HI VOLTS	Refer to the Quattro drive manual.

Fault Number	Name	Definition	Solution
998	LS SIZE	Drive is reporting a LS SIZE	Refer to the Quattro drive manual.
999	LS SW BUS OV	Drive is reporting a LS SW BUS OV	Refer to the Quattro drive manual.
1000	COUNTER WEIGHT DERAIL	The controller CW Derail was triggered.	Verify is the CW derail was activated.
1003	Valve L-Dn OvrlD	Primary valve board reporting Over Current on level speed down output.	Check primary valve board wiring and valve solenoid.
1004	Valve L-Up OvrlD	Primary valve board reporting Over Current on level speed up output.	Check primary valve board wiring and valve solenoid.
1005	Valve H-Dn OvrlD	Primary valve board reporting Over Current on high speed down output.	Check primary valve board wiring and valve solenoid.
1006	Valve H-Up OvrlD	Primary valve board reporting Over Current on high speed up output.	Check primary valve board wiring and valve solenoid.
1007	Valve L-Dn Shrt	Primary valve board reporting a Short on level speed down output.	Check primary valve board wiring and valve solenoid.
1008	Valve L-Up Shrt	Primary valve board reporting a Short on level speed up output.	Check primary valve board wiring and valve solenoid.
1009	Valve H-Dn Shrt	Primary valve board reporting a Short on high speed down output.	Check primary valve board wiring and valve solenoid.
1010	Valve H-Up Shrt	Primary valve board reporting a Short on high speed up output.	Check primary valve board wiring and valve solenoid.
1011	S-Motor Out-Shrt	Motor Start on Primary valve board is reporting a Short	Check motor start wiring between primary valve board and soft starter
1012	Valve L-Dn Open	Primary valve board reporting Open Circuit on the output.	Check primary valve board and wiring.
1013	Valve L-Up Open	Primary valve board reporting Open Circuit on the output.	Check primary valve board and wiring.
1014	Valve H-Dn Open	Primary valve board reporting Open Circuit on the output.	Check primary valve board and wiring.

Fault Number	Name	Definition	Solution
1015	Valve H-Up Open	Primary valve board reporting Open Circuit on the output.	Check primary valve board and wiring.
1016	H-Speed En Fault	Primary valve board High Speed Enable Output Failure	Primary Valve Board Open or Shorted TRIAC Output
1017	Valve2 L-Dn OvrlD	Secondary valve board reporting Over Current on level speed down output.	Check secondary valve board wiring and valve solenoid.
1018	Valve2 L-Up OvrlD	Secondary valve board reporting Over Current on level speed up output.	Check secondary valve board wiring and valve solenoid.
1019	Valve2 H-Dn OvrlD	Secondary valve board reporting Over Current on high speed down output.	Check secondary valve board wiring and valve solenoid.
1020	Valve2 H-Up OvrlD	Secondary valve board reporting Over Current on high speed up output.	Check secondary valve board wiring and valve solenoid.
1021	Valve2 L-Dn Shrt	Secondary valve board reporting a Short on level speed down output.	Check secondary valve board wiring and valve solenoid.
1022	Valve2 L-Up Shrt	Secondary valve board reporting a Short on level speed up output.	Check secondary valve board wiring and valve solenoid.
1023	Valve2 H-Dn Shrt	Secondary valve board reporting a Short on high speed down output.	Check secondary valve board wiring and valve solenoid.
1024	Valve2 H-Up Shrt	Secondary valve board reporting a Short on high speed up output.	Check secondary valve board wiring and valve solenoid.
1025	S-Motor2 Out-Shrt	Motor Start on Secondary valve board is reporting a Short	Check motor start wiring between secondary valve board and soft starter
1026	Valve2 L-Dn Open	Secondary valve board reporting Open Circuit on the output.	Check secondary valve board and wiring.
1027	Valve2 L-Up Open	Secondary valve board reporting Open Circuit on the output.	Check secondary valve board and wiring.
1028	Valve2 H-Dn Open	Secondary valve board reporting Open Circuit on the output.	Check secondary valve board and wiring.

Fault Number	Name	Definition	Solution
1029	Valve2 H-Up Open	Secondary valve board reporting Open Circuit on the output.	Check secondary valve board and wiring.
1030	H-Speed2 En Fault	Secondary valve board High Speed Enable Output Failure	Secondary Valve Board Open or Shorted TRIAC Output
1031	SS3 Input Flt	Discrete input fault 3 from the Soft Starter has been activated.	(Hydro Only) Check the SS 3 Input fault, and the contact feeding the input from the soft starter.
1032	Valve3 Unk	Third valve board reporting an unknown fault.	Check third valve board and wiring.
1033	Valve3 POR Rst	Third valve board recovering from a reset due to power off.	Check third valve board and wiring.
1034	Valve3 WDT Rst	Third valve board recovering from reset due to watchdog.	Check third valve board and wiring.
1035	Valve3 BOD Rst	Third valve board recovering from reset due to voltage dip.	Check third valve board and wiring.
1036	Valve3 Comm Loss	Third valve board reporting loss of communication with elevator controller.	Check third valve board and wiring.
1037	Valve3 Level Dn	Third valve board reporting mismatch between valve control and status signals of level speed down output.	Check third valve board and wiring.
1038	Valve3 Level Up	Third valve board reporting mismatch between valve control and status signals of level speed up output.	Check third valve board and wiring.
1039	Valve3 High Dn	Third valve board reporting mismatch between valve control and status signals of high speed down output.	Check third valve board and wiring.
1040	Valve3 High Up	Third valve board reporting mismatch	Check third valve board and wiring.

Fault Number	Name	Definition	Solution
		between valve control and status signals of high speed up output.	
1041	Valve3 SM	Third valve board reporting mismatch between control and status signals of the start motor output.	Check third valve board and wiring.
1042	Valve3 Inv. Cmd.	Third valve board reporting both up and down commands issued at the same time.	Check third valve board and wiring.
1043	Valve3 CAN Bus Rst	Third valve board reporting a CAN bus reset.	Check third valve board and wiring.
1044	Valve3 Offline	Communication lost with third valve board.	Check third valve board and wiring.
1045	Valve3 Dupl. Addr.	Two third valve boards detected on the network.	Check third valve board addressing.
1046	Bypass UM Redundancy	The MCUB_X8 sent from MRB to CPLD is not consistent with the feedback value from CPLD	
1047	Dir. Counter Tripped	The direction change counter exceeded the maximum allowed value.	Program the direction change counter reset input and activate it.
1048	Glass Window Switch	Glass window switch input has been activated.	Check glass window switch wiring.
1049	Rupture Switch	Rupture switch input has been activated.	Check rupture switch wiring.
1050	Pressure Switch	Pressure switch input has been activated.	Check pressure switch wiring.
1051	Collapsible CT Rail	This fault is asserted if parameter 01-339 is on and one of the following conditions is met : * The car is collapsible fully stowed(input on) and the mode of operation is on CT . * The car is collapsible	Check inputs collapsible fully stowed and collapsible fully extended

Fault Number	Name	Definition	Solution
		fully extended (input on) while the car is not on CT operation. * The car is not fully collapsible extended and not collapsible fully stowed.	
1054	Valve3 L-Dn Ovrlld	Third valve board reporting Over Current on level speed down output.	Check third valve board wiring and valve solenoid.
1055	Valve3 L-Up Ovrlld	Third valve board reporting Over Current on level speed up output.	Check third valve board wiring and valve solenoid.
1056	Valve3 H-Dn Ovrlld	Third valve board reporting Over Current on high speed down output.	Check third valve board wiring and valve solenoid.
1057	Valve3 H-Up Ovrlld	Third valve board reporting Over Current on high speed up output.	Check third valve board wiring and valve solenoid.
1058	Valve3 L-Dn Shrt	Third valve board reporting a Short on level speed down output.	Check third valve board wiring and valve solenoid.
1059	Valve3 L-Up Shrt	Third valve board reporting a Short on level speed up output.	Check third valve board wiring and valve solenoid.
1060	Valve3 H-Dn Shrt	Third valve board reporting a Short on high speed down output.	Check third valve board wiring and valve solenoid.
1061	Valve3 H-Up Shrt	Third valve board reporting a Short on high speed up output.	Check third valve board wiring and valve solenoid.
1062	S-Motor3 Out-Shrt	Motor Start on third valve board is reporting a Short	Check motor start wiring between third valve board and soft starter
1063	Valve3 L-Dn Open	Third valve board reporting Open Circuit on the output.	Check third valve board and wiring.
1064	Valve3 L-Up Open	Third valve board reporting Open Circuit on the output.	Check third valve board and wiring.
1065	Valve3 H-Dn Open	Third valve board reporting Open Circuit on the output.	Check third valve board and wiring.

Fault Number	Name	Definition	Solution
1066	Valve3 H-Up Open	Third valve board reporting Open Circuit on the output.	Check third valve board and wiring.
1067	H-Speed3 En Fault	Third valve board High Speed Enable Output Failure	Third Valve Board Open or Shorted TRIAC Output
1068	SS4 Input Flt	Discrete input fault 4 from the Soft Starter has been activated.	(Hydro Only) Check the SS 4 Input fault, and the contact feeding the input from the soft starter.
1069	Valve4 Unk	Fourth valve board reporting an unknown fault.	Check fourth valve board and wiring.
1070	Valve4 POR Rst	Fourth valve board recovering from a reset due to power off.	Check fourth valve board and wiring.
1071	Valve4 WDT Rst	Fourth valve board recovering from reset due to watchdog.	Check fourth valve board and wiring.
1072	Valve4 BOD Rst	Fourth valve board recovering from reset due to voltage dip.	Check fourth valve board and wiring.
1073	Valve4 Comm Loss	Fourth valve board reporting loss of communication with elevator controller.	Check fourth valve board and wiring.
1074	Valve4 Level Dn	Fourth valve board reporting mismatch between valve control and status signals of level speed down output.	Check fourth valve board and wiring.
1075	Valve4 Level Up	Fourth valve board reporting mismatch between valve control and status signals of level speed up output.	Check fourth valve board and wiring.
1076	Valve4 High Dn	Fourth valve board reporting mismatch between valve control and status signals of high speed down output.	Check fourth valve board and wiring.
1077	Valve4 High Up	Fourth valve board reporting mismatch	Check fourth valve board and wiring.

Fault Number	Name	Definition	Solution
		between valve control and status signals of high speed up output.	
1078	Valve4 SM	Fourth valve board reporting mismatch between control and status signals of the start motor output.	Check fourth valve board and wiring.
1079	Valve4 Inv. Cmd.	Fourth valve board reporting both up and down commands issued at the same time.	Check fourth valve board and wiring.
1080	Valve4 CAN Bus Rst	Fourth valve board reporting a CAN bus reset.	Check fourth valve board and wiring.
1081	Valve4 Offline	Communication lost with fourth valve board.	Check fourth valve board and wiring.
1082	Valve4 Dupl. Addr.	Two fourth valve boards detected on the network.	Check fourth valve board addressing.
1083	Valve4 L-Dn Ovrlid	Fourth valve board reporting Over Current on level speed down output.	Check fourth valve board wiring and valve solenoid.
1084	Valve4 L-Up Ovrlid	Fourth valve board reporting Over Current on level speed up output.	Check fourth valve board wiring and valve solenoid.
1085	Valve4 H-Dn Ovrlid	Fourth valve board reporting Over Current on high speed down output.	Check fourth valve board wiring and valve solenoid.
1086	Valve4 H-Up Ovrlid	Fourth valve board reporting Over Current on high speed up output.	Check fourth valve board wiring and valve solenoid.
1087	Valve4 L-Dn Shrt	Fourth valve board reporting a Short on level speed down output.	Check fourth valve board wiring and valve solenoid.
1088	Valve4 L-Up Shrt	Fourth valve board reporting a Short on level speed up output.	Check fourth valve board wiring and valve solenoid.
1089	Valve4 H-Dn Shrt	Fourth valve board reporting a Short on high speed down output.	Check fourth valve board wiring and valve solenoid.

Fault Number	Name	Definition	Solution
1090	Valve4 H-Up Shrt	Fourth valve board reporting a Short on high speed up output.	Check fourth valve board wiring and valve solenoid.
1091	S-Motor4 Out-Shrt	Motor Start on fourth valve board is reporting a Short	Check motor start wiring between fourth valve board and soft starter
1092	Valve4 L-Dn Open	Fourth valve board reporting Open Circuit on the output.	Check fourth valve board and wiring.
1093	Valve4 L-Up Open	Fourth valve board reporting Open Circuit on the output.	Check fourth valve board and wiring.
1094	Valve4 H-Dn Open	Fourth valve board reporting Open Circuit on the output.	Check fourth valve board and wiring.
1095	Valve4 H-Up Open	Fourth valve board reporting Open Circuit on the output.	Check fourth valve board and wiring.
1096	H-Speed4 En Fault	Fourth valve board High Speed Enable Output Failure	Fourth Valve Board Open or Shorted TRIAC Output
1097	Oil Over Heat	Oil temperature is great than maximum allowance	(Hydro Only) Check oil temperature, Oil Overheat Input, then reset the latching fault via the reset button.
1098	OOS Redun. Disp.	The car has been taken out of service because of riser 1 or riser 2 offline.	Check riser 1 or riser 2 status

42.4.12 Motion Control

The table below lists the faults related to Motion Control.

Table 69: List of Faults related to Motion Control

Fault Number	Name	Definition	Solution
175	Mo. Inv. Cmd	A motion control error has occurred.	NA
176	Mo. Prepare Run	Motion start sequence aborted due to unsafe door state.	Check door contacts.
177	Mo. Drive Enable	NA	NA
178	Mo. Pick M	Motion start sequence aborted due to missing M contactor feedback.	NA

Fault Number	Name	Definition	Solution
179	Mo. Speed Reg	Motion start sequence aborted due to missing serial drive control feedback.	NA
180	Mo. Pick B2	Motion start sequence aborted due to missing B2 contactor feedback.	NA
181	Mo. Lift Brake	Motion start sequence aborted due to missing BPS feedback.	Verify BPS wiring and inversion parameter.
182	Mo. Accel Delay	Requested run distance is too short (less than 0.25 inch).	Verify the car is not rolling back at the start of run.
183	Mo. Ramp To Zero	Motion stop sequence aborted after failing to ramp to zero speed.	NA
184	Mo. Hold Zero	Motion stop sequence aborted after failing to achieve encoder speed of or below 1 fpm.	NA
185	Mo. Check BPS	Motion stop sequence aborted after failing BPS check.	Verify BPS wiring and inversion parameter.
186	Mo. Deenergize	NA	NA
187	Mo. Drop M	Motion stop sequence aborted after failing to drop the M contactor.	NA
188	Mo. Preflight	Motion stop sequence aborted after failing to complete preflight.	NA
804	Mo. Pick B1	Motion start sequence aborted due to missing B contactor feedback.	NA
809	Mo. Prepare GSWF Open	Motion start sequence aborted due to incorrect GSWF state.	Check the GSWF contact.
810	Mo. Prepare LFT Open	Motion start sequence aborted due to incorrect LFT state.	Check the LFT contact.
811	Mo. Prepare LFM Open	Motion start sequence aborted due to incorrect LFM state.	Check the LFM contact.

Fault Number	Name	Definition	Solution
812	Mo. Prepare DPM F Open	Motion start sequence aborted due to incorrect DPM F state.	Check the DPM F contact
813	Mo. Prepare LFB Open	Motion start sequence aborted due to incorrect LFB state.	Check the LFB contact.
814	Mo. Prepare GSWR Open	Motion start sequence aborted due to incorrect GSWR state.	Check the GSWR contact.
815	Mo. Prepare LRT Open	Motion start sequence aborted due to incorrect LRT state.	Check the LRT contact.
816	Mo. Prepare LRM Open	Motion start sequence aborted due to incorrect LRM state.	Check the LRM contact.
817	Mo. Prepare LRB Open	Motion start sequence aborted due to incorrect LRB state.	Check the LRB contact.
818	Mo. Prepare DPM R Open	Motion start sequence aborted due to incorrect DPM R state.	Check the DPM R contact.
819	Mo. Accel GSWF Open	Motion start sequence aborted due to missing GSWF.	Check the GSWF contact.
820	Mo. Accel LFT Open	Motion start sequence aborted due to missing LFT .	Check the LFT contact.
821	Mo. Accel LFM Open	Motion start sequence aborted due to missing LFM.	Check the LFM contact.
822	Mo. Accel LFB Open	Motion start sequence aborted due to missing LFB.	Check the LFB contact.
823	Mo. Accel DPM F Open	Motion start sequence aborted due to missing DPM F.	Check the DPM F contact.
824	Mo. Accel GSWR Open	Motion start sequence aborted due to missing GSWR.	Check the GSWR contact.
825	Mo. Accel LRT Open	Motion start sequence aborted due to missing LRT.	Check the LRT contact.

Fault Number	Name	Definition	Solution
826	Mo. Accel LRM Open	Motion start sequence aborted due to missing LRM.	Check the LRM contact.
827	Mo. Accel LRB Open	Motion start sequence aborted due to missing LRB.	Check the LRB contact.
828	Mo. Accel DPM R Open	Motion start sequence aborted due to missing DPM R.	Check the DPM R contact.
829	Mo. Prepare DCL F	Motion start sequence aborted due to incorrect DCL F state.	Check the DCL F contact.
830	Mo. Prepare DCL R	Motion start sequence aborted due to incorrect DCL R state.	Check the DCL R contact.
831	Mo. Prepare DOL F	Motion start sequence aborted due to incorrect DOL F state.	Check the DOL F contact.
832	Mo. Prepare DOL R	Motion start sequence aborted due to incorrect DOL R state.	Check the DOL R contact.
833	Mo. Accel DCL F	Motion start sequence aborted due to missing DCL F.	Check the DCL F contact.
834	Mo. Accel DCL R	Motion start sequence aborted due to missing DCL R.	Check the DCL R contact.
835	Mo. Accel DOL F	Motion start sequence aborted due to incorrect DOL F state.	Check the DOL F contact.
836	Mo. Accel DOL R	Motion start sequence aborted due to incorrect DOL R state.	Check the DOL R contact.
879	Mo. Run Engaged	Motion start sequence aborted due to missing DSD output Run Engaged.	Check the wiring of the DSD run engaged output to the C4 controller. Confirm that the output is programmed on the DSD drive and the corresponding input is programmed on the C4 controller.

42.4.13 Parameters

The table below lists the faults related to Parameters.

Table 70: List of Faults related to Parameters

Fault Number	Name	Definition	Solution
118	MRA Param OVF	Machine room processor A parameter edit buffer overflowed.	Reduce rate of parameter edit requests.
119	MRB Param OVF	Machine room processor B parameter edit buffer overflowed.	Reduce rate of parameter edit requests.
120	CTA Param OVF	Car top processor A parameter edit buffer overflowed.	Reduce rate of parameter edit requests.
121	CTB Param OVF	Car top processor B parameter edit buffer overflowed.	Reduce rate of parameter edit requests.
122	COPA Param OVF	Car operating panel processor A parameter edit buffer overflowed.	Reduce rate of parameter edit requests.
123	COPB Param OVF	Car operating panel processor B parameter edit buffer overflowed.	Reduce rate of parameter edit requests.
250	MRB Param Sync	Parameters are synchronizing.	NA
251	CTA Param Sync	Parameters are synchronizing.	NA
252	CTB Param Sync	Parameters are synchronizing.	NA
900	COPA Param Sync	Parameters are synchronizing.	NA
901	COPB Param Sync	Parameters are synchronizing.	NA
907	Restore Drive Param	Restore the drive parameters after Acceptance test completion or if the acceptance test is interrupted (If the FRAM values for drive parameter is nonzero)	Turn On A1 dip switch and hit reset, this will make the FRAM values for the drive parameters 0

42.4.14 Rescue Device

The table below lists the faults related to Rescue Device.

Table 71: List of Faults related to Rescue Device

Fault Number	Name	Definition	Solution
302	Rescue Start	After moving to rescue operation, the car waits a minimum of 2 seconds before beginning rescue.	NA
303	Rescue In DZ	The car has arrived at the nearest opening, opened its doors, and gone out of service.	NA
304	Rescue Invalid	Auto: No valid recall floor was found. Manual: Invalid run state.	Turn off automatic rescue and perform a manual rescue.
656	Battery Check Fail	Battery lowering device is reporting a fault state. (Hydro Only): If Battery Test Time is set under SETUP Hydro Battery Test Time. The BLD reported 3 or more battery faults within 3 days.	Check backup battery (Hydro Only): If fault occurred from BLD reporting 3 or more faults within 3 days check backup battery and toggle DIP A1.

42.4.15 Digital S-curve Technology™ (U.S. Patent Pending)

The table below lists the faults related to Digital S-curve Technology™ (U.S. Patent Pending).

Table 72: List of Faults related to Digital S-curve Technology™ (U.S. Patent Pending)

Fault Number	Name	Definition	Solution
237	Inv. Accel Curve	Requested acceleration curve is invalid.	Increase current Digital S-curve Technology™ (U.S. Patent Pending) acceleration rate parameters.
238	Inv. Decel Curve	Requested deceleration curve is invalid.	Increase current Digital S-curve Technology™ (U.S. Patent Pending) deceleration rate parameters.
239	Inv. Added Curve	Requested mid run acceleration curve is invalid.	Increase current Digital S-curve Technology™ (U.S. Patent Pending) acceleration rate parameters.
240	Inv. RSL Curve	Requested mid run deceleration curve is invalid.	Increase current Digital S-curve Technology™ (U.S. Patent Pending) deceleration rate parameters.
241	Inv. Profile 1	Normal profile Digital S-curve Technology™ (U.S. Patent Pending) settings are invalid.	Increase the profile's acceleration or deceleration rate parameters.

Fault Number	Name	Definition	Solution
242	Inv. Profile 2	Inspection profile Digital S-curve Technology™ (U.S. Patent Pending) settings are invalid.	Increase the profile's acceleration or deceleration rate parameters.
243	Inv. Profile 3	E-Power profile Digital S-curve Technology™ (U.S. Patent Pending) settings are invalid.	Increase the profile's acceleration or deceleration rate parameters.
244	Inv. Profile 4	Short profile Digital S-curve Technology™ (U.S. Patent Pending) settings are invalid.	Increase the profile's acceleration or deceleration rate parameters.
253	Digital S-curve Technology™ (U.S. Patent Pending) Update	Motion parameters are being recalculated.	NA
677	RS Buffer P1	Digital S-curve Technology™ (U.S. Patent Pending) normal profile decel exceeds limit for reduced speed buffer.	Lower the Digital S-curve Technology™ (U.S. Patent Pending) decel parameters until the fault clears.
678	RS Buffer P2	Digital S-curve Technology™ (U.S. Patent Pending) inspection profile decel exceeds limit for reduced speed buffer.	Lower the Digital S-curve Technology™ (U.S. Patent Pending) decel parameters until the fault clears.
679	RS Buffer P3	Digital S-curve Technology™ (U.S. Patent Pending) e-power profile decel exceeds limit for reduced speed buffer.	Lower the Digital S-curve Technology™ (U.S. Patent Pending) decel parameters until the fault clears.
680	RS Buffer P4	Digital S-curve Technology™ (U.S. Patent Pending) short profile decel exceeds limit for reduced speed buffer.	Lower the Digital S-curve Technology™ (U.S. Patent Pending) decel parameters until the fault clears.

42.4.16 Safety

The table below lists the faults related to Safety.

Table 73: List of Faults related to Safety

Fault Number	Name	Definition	Solution
1	Governor	Governor safety input is currently low.	Check wiring and safety contacts.
2	Governor (L)	Governor fault is latched.	Press the EBRK RST button to clear.
3	EB1 Drop	EB1 relay is currently dropped.	NA
4	EB1 Drop (L)	EB1 fault is latched.	Press the EBRK RST button to clear.
5	Unintended Move	A GSW and Lock is open, and the car is more than two and a half inches from the nearest learned floor position. The movement direction disagrees with the commanded.	Check wiring and safety contacts.
6	Unintended Move (L)	Unintended movement fault is latched.	Press the EBRK RST button to clear.
7	Traction Loss	Car speed has deviated from the motor encoder speed by an adjustable percentage.	Confirm system and drive contract speed match.
8	Traction Loss (L)	Traction loss fault is latched.	Press TLOSS button to clear.
10	IC Stop Sw	In car stop switch (COP-SF2) input is missing.	Check wiring and safety contacts.
11	Redun. LRB	Input read by the main MCU system and the CPLD safety system do not match.	Verify the board has its RDC jumper on.
12	Redun. LRM	Input read by the main MCU system and the CPLD safety system do not match.	Verify the board has its RDC jumper on.
13	Redun. LRT	Input read by the main MCU system and the CPLD safety system do not match.	Verify the board has its RDC jumper on.
14	Redun. LFB	Input read by the main MCU system and the CPLD safety system do not match.	Verify the board has its RDC jumper on.
15	Redun. LFM	Input read by the main MCU system and the	Verify the board has its RDC jumper on.

Fault Number	Name	Definition	Solution
		CPLD safety system do not match.	
16	Redun. LFT	Input read by the main MCU system and the CPLD safety system do not match.	Verify the board has its RDC jumper on.
17	Redun. ATU	Input read by the main MCU system and the CPLD safety system do not match.	Verify the board has its RDC jumper on.
18	Redun. ATD	Input read by the main MCU system and the CPLD safety system do not match.	Verify the board has its RDC jumper on.
19	Redun. ABU	Input read by the main MCU system and the CPLD safety system do not match.	Verify the board has its RDC jumper on.
20	Redun. ABD	Input read by the main MCU system and the CPLD safety system do not match.	Verify the board has its RDC jumper on.
21	Redun. Car Byp	Input read by the main MCU system and the CPLD safety system do not match.	Verify the board has its RDC jumper on.
22	Redun. HA Byp	Input read by the main MCU system and the CPLD safety system do not match.	Verify the board has its RDC jumper on.
23	Redun. MM	Input read by the main MCU system and the CPLD safety system do not match.	Verify the board has its RDC jumper on.
24	Redun. SFM	Input read by the main MCU system and the CPLD safety system do not match.	Verify the board has its RDC jumper on.
25	Redun. SFH	Input read by the main MCU system and the CPLD safety system do not match.	Verify the board has its RDC jumper on.

Fault Number	Name	Definition	Solution
26	Redun. PIT	Input read by the main MCU system and the CPLD safety system do not match.	Verify the board has its RDC jumper on.
27	Redun. IP Insp	Input read by the main MCU system and the CPLD safety system do not match.	Verify the board has its RDC jumper on.
28	Redun. MR Insp	Input read by the main MCU system and the CPLD safety system do not match.	Verify the board has its RDC jumper on.
29	Redun. IL Insp	Input read by the main MCU system and the CPLD safety system do not match.	Verify the board has its RDC jumper on.
30	Redun. C EB2	Input read by the main MCU system and the CPLD safety system do not match.	Verify the board has its RDC jumper on.
31	Redun. C SFM	Input read by the main MCU system and the CPLD safety system do not match.	Verify the board has its RDC jumper on.
32	Redun. M EB2	Input read by the main MCU system and the CPLD safety system do not match.	Verify the board has its RDC jumper on.
33	Redun. M SFM	Input read by the main MCU system and the CPLD safety system do not match.	Verify the board has its RDC jumper on.
34	Redun. M EB3	Input read by the main MCU system and the CPLD safety system do not match.	Verify the board has its RDC jumper on.
35	Redun. M EB1	Input read by the main MCU system and the CPLD safety system do not match.	Verify the board has its RDC jumper on.
36	Redun. M SFP	Input read by the main MCU system and the	Verify the board has its RDC jumper on.

Fault Number	Name	Definition	Solution
		CPLD safety system do not match.	
37	Redun. C EB3	Input read by the main MCU system and the CPLD safety system do not match.	Verify the board has its RDC jumper on.
38	Redun. C EB1	Input read by the main MCU system and the CPLD safety system do not match.	Verify the board has its RDC jumper on.
39	Redun. C SFP	Input read by the main MCU system and the CPLD safety system do not match.	Verify the board has its RDC jumper on.
40	Redun. GSWR	Input read by the main MCU system and the CPLD safety system do not match.	Verify the board has its RDC jumper on.
41	Redun. GSWF	Input read by the main MCU system and the CPLD safety system do not match.	Verify the board has its RDC jumper on.
42	Redun. CT Insp	Input read by the main MCU system and the CPLD safety system do not match.	Verify the board has its RDC jumper on.
43	Redun. CT Stop Sw	Input read by the main MCU system and the CPLD safety system do not match.	Verify the board has its RDC jumper on.
44	Redun. Esc Hatch	Input read by the main MCU system and the CPLD safety system do not match.	Verify the board has its RDC jumper on.
45	Redun. Car Safety	Input read by the main MCU system and the CPLD safety system do not match.	Verify the board has its RDC jumper on.
46	Redun. Fire Stop Sw	Input read by the main MCU system and the CPLD safety system do not match.	Verify the board has its RDC jumper on.

Fault Number	Name	Definition	Solution
47	Redun. IC Stop	Input read by the main MCU system and the CPLD safety system do not match.	Verify the board has its RDC jumper on.
48	Redun. IC Insp	Input read by the main MCU system and the CPLD safety system do not match.	Verify the board has its RDC jumper on.
49	Redun. HA Insp	Input read by the main MCU system and the CPLD safety system do not match.	Verify the board has its RDC jumper on.
50	SFP Stuck Lo	SFP relay is stuck in the OFF position.	Verify the relay is tightly seated on its connector.
51	SFP Stuck Hi	SFP relay is stuck in the ON position.	Verify the relay is tightly seated on its connector.
52	SFP Drop	SFP relay has been dropped.	Investigate the fault issued by the CPLD.
53	EB3 Stuck Lo	EB3 relay is stuck in the OFF position.	Verify the relay is tightly seated on its connector.
54	EB3 Stuck Hi	EB3 relay is stuck in the ON position.	Verify the relay is tightly seated on its connector.
55	EB4 Stuck Lo	EB4 relay is stuck in the OFF position.	Verify the relay is tightly seated on its connector.
56	EB4 Stuck Hi	EB4 relay is stuck in the ON position.	Verify the relay is tightly seated on its connector.
57	EB1 Stuck	EB1 relay is stuck.	Verify the relay is tightly seated on its connector.
58	M Cont. Stuck Hi	M contactor is stuck in the ON position.	Check the wiring to and from the M contactor.
59	M Cont. Stuck Lo	M contactor is stuck in the OFF position.	Check the wiring to and from the M contactor.
60	B2 Cont. Stuck Hi	B2 contactor is stuck in the ON position.	Check the wiring to and from the B2 contactor.
61	B2 Cont. Stuck Lo	B2 contactor is stuck in the OFF position.	Check the wiring to and from the B2 contactor.
62	HA Bypass Sw	Hall door bypass switch is ON.	Turn off machine room board H-DOOR switch.
63	Car Bypass Sw	Car door bypass switch is ON.	Turn off machine room board C-DOOR switch.
92	Inv. ETS 1	Normal profile ETS points are not of increasing in	Cycle power to the system or edit a Digital S-curve Technology™ (U.S.

Fault Number	Name	Definition	Solution
		position/speed value or a trip speed exceeds contract speed.	Patent Pending) parameter to trigger a ETS point recalculation.
93	Inv. ETS 2	Inspection profile ETS points are not of increasing in position/speed value or a trip speed exceeds contract speed.	Cycle power to the system or edit a Digital S-curve Technology™ (U.S. Patent Pending) parameter to trigger a ETS point recalculation.
94	Inv. ETS 3	Emergency profile ETS points are not of increasing in position/speed value or a trip speed exceeds contract speed.	Cycle power to the system or edit a Digital S-curve Technology™ (U.S. Patent Pending) parameter to trigger a ETS point recalculation.
95	Inv. ETS 4	Short profile ETS points are not of increasing in position/speed value or a trip speed exceeds contract speed.	Cycle power to the system or edit a Digital S-curve Technology™ (U.S. Patent Pending) parameter to trigger a ETS point recalculation.
117	EB Byp	EB3 or EB4 bypass relay is stuck in the ON position.	NA
154	SS SFH	Hoistway safety (MR-SFH) input missing.	Check wiring and safety contacts.
155	SS SFM	Machine room safety (MR-SFM) input missing.	Check wiring and safety contacts.
156	SS PIT	Pit (MR-PIT) input missing.	Check wiring and safety contacts.
157	SS BUF	Buffer (MR-BUF) input missing.	Check wiring and safety contacts.
158	SS TFL	Top final limit (MR-TFL) input missing.	Check wiring and safety contacts.
159	SS BFL	Bottom final limit (MR-BFL) input missing.	Check wiring and safety contacts.
160	SS CT Stop Sw	Car top switch (CT-SF1) input missing.	Check wiring and safety contacts.
161	SS Esc Hatch	Car top escape hatch (CT-SF2) input missing.	Check wiring and safety contacts.
162	SS Car Safeties	Car top car safeties (CT-SF3) input missing.	Check wiring and safety contacts.
163	LFT Open	Front top lock is open.	Check wiring and safety contacts.

Fault Number	Name	Definition	Solution
164	LFM Open	Front middle lock is open.	Check wiring and safety contacts.
165	LFB Open	Front bottom lock is open.	Check wiring and safety contacts.
166	LRT Open	Rear top lock is open.	Check wiring and safety contacts.
167	LRM Open	Rear middle lock is open.	Check wiring and safety contacts.
168	LRB Open	Rear bottom lock is open.	Check wiring and safety contacts.
169	GSWF Open	Front gate switch is open.	Check wiring and safety contacts.
170	GSWR Open	Rear gate switch is open.	Check wiring and safety contacts.
191	EB2 Drop	Rope gripper relay EB2 was dropped.	NA
192	EB2 Stuck	EB2 relay is stuck.	Verify the relay is tightly seated on its connector.
245	SFM Stuck	SFM relay is stuck.	Verify the relay is tightly seated on its connector.
247	MR Preflight	Preflight test failed.	NA
248	CT Preflight	Preflight test failed.	NA
249	COP Preflight	Preflight test failed.	NA
265	B Cont. Hi HW	B contactor feedback is stuck high.	Check the wiring to and from the B contactor.
267	B Cont. Lo HW	B contactor feedback is stuck low.	Check the wiring to and from the B contactor.
305	MR Safety	Machine room safety input (SFM) was lost.	Check wiring and safety contacts.
657	Inv. ETSL 1	Normal profile ETSL points are not of increasing in position/speed value or a trip speed exceeds contract speed.	Cycle power to the system or edit a Digital S-curve Technology™ (U.S. Patent Pending) parameter to trigger a ETSL point recalculation.
658	Inv. ETSL 2	Inspection profile ETSL points are not of increasing in position/speed value or a trip speed exceeds contract speed.	Cycle power to the system or edit a Digital S-curve Technology™ (U.S. Patent Pending) parameter to trigger a ETSL point recalculation.
659	Inv. ETSL 3	Emergency profile ETSL points are not of increasing in position/speed value or a trip speed exceeds contract speed.	Cycle power to the system or edit a Digital S-curve Technology™ (U.S. Patent Pending) parameter to trigger a ETSL point recalculation.

Fault Number	Name	Definition	Solution
660	Inv. ETSL 4	Short profile ETSL points are not of increasing in position/speed value or a trip speed exceeds contract speed.	Cycle power to the system or edit a Digital S-curve Technology™ (U.S. Patent Pending) parameter to trigger a ETSL point recalculation.
719	Front TCL Open	Front top closed interlock is open	Check wiring of TCL, GSW and DZ signals. This fault is flagged when outside of DZ and TCL is open. It is also flagged when GSW is closed and TCL is open.
720	Front MCL Open	Front middle closed interlock is open	Check wiring of MCL, GSW and DZ signals. This fault is flagged when outside of DZ and MCL is open. It is also flagged when GSW is closed and MCL is open.
721	Front BCL Open	Front bottom closed interlock is open	Check wiring of BCL, GSW and DZ signals. This fault is flagged when outside of DZ and BCL is open. It is also flagged when GSW is closed and BCL is open.
722	Rear TCL Open	Rear top closed interlock is open	Check wiring of TCL, GSW and DZ signals. This fault is flagged when outside of DZ and TCL is open. It is also flagged when GSW is closed and TCL is open.
723	Rear MCL Open	Rear middle closed interlock is open	Check wiring of MCL, GSW and DZ signals. This fault is flagged when outside of DZ and MCL is open. It is also flagged when GSW is closed and MCL is open.
724	Rear BCL Open	Rear bottom closed interlock is open	Check wiring of BCL, GSW and DZ signals. This fault is flagged when outside of DZ and BCL is open. It is also flagged when GSW is closed and BCL is open.
727	Unint. LCK And GSW	A GSW and Lock is open and the car is more than two and a half inches from the nearest learned floor position. The movement direction	Check wiring and safety contacts.

Fault Number	Name	Definition	Solution
		agrees with the commanded.	
728	DPMF Open	Front DPM Open	Check wiring and safety contacts.
729	DPMR Open	Rear DPM Open	Check wiring and safety contacts.
917	EB1 Drop H	EB1 relay which is controlled by the redundant safety processor (and should normally follow the EB2 relay) is currently dropped when it should be picked.	(Hydro Only) Check the status of the EB1 and EB2 relays.
1052	SS TFL2	Second Top final limit (MR-TFL2) input missing.	Check wiring and safety contacts.

42.4.17 Speed

The table below lists the faults related to Speed.

Table 74: List of Faults related to Speed

Fault Number	Name	Definition	Solution
1	Speed Dev	Car speed has deviated from the command speed by an adjustable percentage. (Hydro): Indicates a speed issue when a valve is active.	Confirm system and drive contract speed match, clean CEDES tape, or reduce Digital S-curve Technology™ (U.S. Patent Pending) values. (Hydro): Check for a valve that is not opening.
9	General OVSP	Car speed exceeded 110% of contract speed.	Confirm system and drive contract speed match or reduce Digital S-curve Technology™ (U.S. Patent Pending) values.
64	General OVSP (L)	Car overspeed fault is latched.	Press EBRK RST button to clear.
65	Insp OVSP	Car speed exceeded 150 fpm in inspection mode.	Confirm system and drive contract speed match.
66	Door OVSP GSWF	Car speed exceeded 150 fpm with front gate switch open.	Confirm system and drive contract speed match. Check door contacts and wiring.
67	Door OVSP LFT	Car speed exceeded 150 fpm with front top lock open.	Confirm system and drive contract speed match. Check door contacts and wiring.

Fault Number	Name	Definition	Solution
68	Door OVSP LFM	Car speed exceeded 150 fpm with front middle lock open.	Confirm system and drive contract speed match. Check door contacts and wiring.
69	Door OVSP LFB	Car speed exceeded 150 fpm with front bottom lock open.	Confirm system and drive contract speed match. Check door contacts and wiring.
70	Door OVSP GSWR	Car speed exceeded 150 fpm with rear gate switch open.	Confirm system and drive contract speed match. Check door contacts and wiring.
71	Door OVSP LRT	Car speed exceeded 150 fpm with rear top lock open.	Confirm system and drive contract speed match. Check door contacts and wiring.
72	Door OVSP LRM	Car speed exceeded 150 fpm with rear middle lock open.	Confirm system and drive contract speed match. Check door contacts and wiring.
73	Door OVSP LRB	Car speed exceeded 150 fpm with rear bottom lock open.	Confirm system and drive contract speed match. Check door contacts and wiring.
85	Inv. Contract Spd	Contract speed setting is outside the valid range.	Set contract speed to a value from 10 to 1600.
86	Inv. Insp Spd	Inspection speed setting is outside the valid range.	Set inspection speed to a value from 0 to 150.
87	Inv. Learn Spd	Learn speed setting is outside the valid range.	Set learn speed to a value from 10 to contract speed.
88	Inv. Term Spd	Terminal speed setting is outside the valid range.	Set terminal speed to a value from 0 to 30.
89	Inv. Level Spd	Leveling speed setting is outside the valid range.	Set leveling speed to a value from 1 to 20.
90	Inv. NTSD Spd	NTS speed setting is outside the valid range.	Set NTS speed to a value from 1 to 20.
255	Constr. OVSP	The encoder speed has exceeded the speed command by over 25 fpm.	Option to disable this fault is available via 01-0073.
264	Speed Reg Hi	Drive's serial speed reg signal is stuck high when it should be commanded low.	Check drive's speed reg settings for correct serial mapping.
266	Speed Reg Lo	Drive's serial speed reg signal is stuck low when should be commanded high.	Check drive's speed reg settings for correct serial mapping.

Fault Number	Name	Definition	Solution
681	UETS OVSP 1	Car speed exceeded the top terminal speed limit.	Lower your deceleration curve parameters or increase the ETS debounce limit.
682	UETS OVSP 2	Car speed exceeded the top terminal speed limit.	Lower your deceleration curve parameters or increase the ETS debounce limit.
683	UETS OVSP 3	Car speed exceeded the top terminal speed limit.	Lower your deceleration curve parameters or increase the ETS debounce limit.
684	UETS OVSP 4	Car speed exceeded the top terminal speed limit.	Lower your deceleration curve parameters or increase the ETS debounce limit.
685	UETS OVSP 5	Car speed exceeded the top terminal speed limit.	Lower your deceleration curve parameters or increase the ETS debounce limit.
686	UETS OVSP 6	Car speed exceeded the top terminal speed limit.	Lower your deceleration curve parameters or increase the ETS debounce limit.
687	UETS OVSP 7	Car speed exceeded the top terminal speed limit.	Lower your deceleration curve parameters or increase the ETS debounce limit.
688	UETS OVSP 8	Car speed exceeded the top terminal speed limit.	Lower your deceleration curve parameters or increase the ETS debounce limit.
689	DETS OVSP 1	Car speed exceeded the bottom terminal speed limit.	Lower your deceleration curve parameters or increase the ETS debounce limit.
690	DETS OVSP 2	Car speed exceeded the bottom terminal speed limit.	Lower your deceleration curve parameters or increase the ETS debounce limit.
691	DETS OVSP 3	Car speed exceeded the bottom terminal speed limit.	Lower your deceleration curve parameters or increase the ETS debounce limit.
692	DETS OVSP 4	Car speed exceeded the bottom terminal speed limit.	Lower your deceleration curve parameters or increase the ETS debounce limit.
693	DETS OVSP 5	Car speed exceeded the bottom terminal speed limit.	Lower your deceleration curve parameters or increase the ETS debounce limit.
694	DETS OVSP 6	Car speed exceeded the bottom terminal speed limit.	Lower your deceleration curve parameters or increase the ETS debounce limit.

Fault Number	Name	Definition	Solution
695	DETS OVSP 7	Car speed exceeded the bottom terminal speed limit.	Lower your deceleration curve parameters or increase the ETS debounce limit.
696	DETS OVSP 8	Car speed exceeded the bottom terminal speed limit.	Lower your deceleration curve parameters or increase the ETS debounce limit.
697	UETSL OVSP 1	Car speed exceeded the top terminal speed limit.	Lower your deceleration curve parameters or increase the ETSL debounce limit.
698	UETSL OVSP 2	Car speed exceeded the top terminal speed limit.	Lower your deceleration curve parameters or increase the ETSL debounce limit.
699	UETSL OVSP 3	Car speed exceeded the top terminal speed limit.	Lower your deceleration curve parameters or increase the ETSL debounce limit.
700	UETSL OVSP 4	Car speed exceeded the top terminal speed limit.	Lower your deceleration curve parameters or increase the ETSL debounce limit.
701	UETSL OVSP 5	Car speed exceeded the top terminal speed limit.	Lower your deceleration curve parameters or increase the ETSL debounce limit.
702	UETSL OVSP 6	Car speed exceeded the top terminal speed limit.	Lower your deceleration curve parameters or increase the ETSL debounce limit.
703	UETSL OVSP 7	Car speed exceeded the top terminal speed limit.	Lower your deceleration curve parameters or increase the ETSL debounce limit.
704	UETSL OVSP 8	Car speed exceeded the top terminal speed limit.	Lower your deceleration curve parameters or increase the ETSL debounce limit.
705	DETS OVSP 1	Car speed exceeded the bottom terminal speed limit.	Lower your deceleration curve parameters or increase the ETSL debounce limit.
706	DETS OVSP 2	Car speed exceeded the bottom terminal speed limit.	Lower your deceleration curve parameters or increase the ETSL debounce limit.
707	DETS OVSP 3	Car speed exceeded the bottom terminal speed limit.	Lower your deceleration curve parameters or increase the ETSL debounce limit.
708	DETS OVSP 4	Car speed exceeded the bottom terminal speed limit.	Lower your deceleration curve parameters or increase the ETSL debounce limit.

Fault Number	Name	Definition	Solution
709	DETSL OVSP 5	Car speed exceeded the bottom terminal speed limit.	Lower your deceleration curve parameters or increase the ETSL debounce limit.
710	DETSL OVSP 6	Car speed exceeded the bottom terminal speed limit.	Lower your deceleration curve parameters or increase the ETSL debounce limit.
711	DETSL OVSP 7	Car speed exceeded the bottom terminal speed limit.	Lower your deceleration curve parameters or increase the ETSL debounce limit.
712	DETSL OVSP 8	Car speed exceeded the bottom terminal speed limit.	Lower your deceleration curve parameters or increase the ETSL debounce limit.
726	Inv. ACCESS Spd	Access speed setting is outside the valid range.	Set access speed to a value from 0 to 150.
878	TSRD OVSP	Car speed exceeded the top terminal speed limit.	(Hydro Only) Increase the TSRD position offset, increase the TSRD debounce limit, or adjust the learned slowdown points.

43 Alarms

The Alarms menu shows the alarms reported by the hardware.

43.1 Active Alarms

When an alarm occurs, the description of the type of alarm is displayed in Active Alarms.

The following procedure describes how to view the list of active alarms.

1. Navigate to MAIN MENU | ALARMS | ACTIVE (See Figure 55).
2. From the ACTIVE ALARMS menu, view the list of alarms that are preventing operation.



Figure 719: Active Alarms Menu

3. From the ACTIVE ALARMS menu, scroll and press the right button for more description of the alarm. See Section 42.4 List of Faults and Section 43.4 List of Alarms for more information.

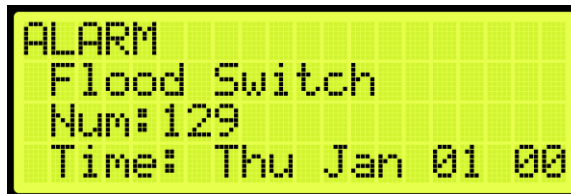

Figure 720: Alarm Part 1 of 2

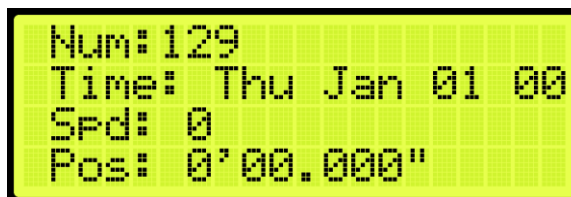

Figure 721: Alarm Part 2 of 2

43.2 Logged Alarms

All alarms that have occurred are logged. The Logged Alarms displays a history of the last 32 alarms on the CT and COP boards and the last 256 alarms on the MR board.

The following procedure describes how to view the list of logged alarms.

1. Navigate to MAIN MENU | ALARMS | LOGGED (See Figure 55).
2. From the ALARM LOG menu, view the list of alarms that have occurred.

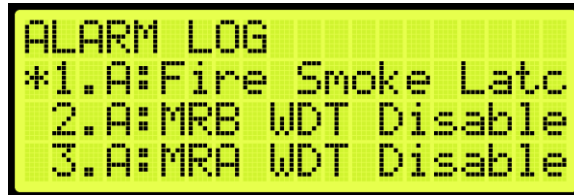

Figure 722: ALARM LOG Menu

43.3 Cleared Alarms

Cleared alarms deletes the history of recorded alarms.

The following procedure describes how to clear the alarm log.

1. Navigate to MAIN MENU | ALARMS | CLEAR LOG (See Figure 55).
2. From the CLEAR ALARM LOG menu, press the right button and select Yes.



Figure 723: CLEAR ALARM LOG Menu

43.4 List of Alarms

The following sections list the possible alarms that could be encountered.

43.4.1 CPLD

The table below lists the alarms related to CPLD.

Table 75: List of Alarms related to CPLD

Fault Number	Name	Definition	Solution
125	CPLD Offline MR	Debugging communication timer with MR CPLD elapsed.	NA
126	CPLD Offline CT	Debugging communication timer with CT CPLD elapsed.	NA
127	CPLD Offline COP	Debugging communication timer with COP CPLD elapsed.	NA
1420	CPLD OVF MR	CPLD communication buffers have been overrun.	Contact smartrise support.
1421	CPLD OVF CT	CPLD communication buffers have been overrun.	Contact smartrise support.
1422	CPLD OVF COP	CPLD communication buffers have been overrun.	Contact smartrise support.

43.4.2 Doors

The table below lists the alarms related to Doors.

Table 76: List of Alarms related to Doors

Fault Number	Name	Definition	Solution
77	Stop No DZ	Car is stopped outside of a door zone.	NA
84	Recall Inv Door	Requested recall destination has an invalid door configuration.	NA
115	Inv Man Run Door	Manual run request rejected due to invalid car door state.	NA
120	Inv Man Run DOBF	Manual run request rejected due to front door open button request.	NA
121	Inv Man Run DOBR	Manual run request rejected due to rear door open button request.	NA
629	Door Open In Motion	Test alarm signaling that both locks and gsw are	NA

Fault Number	Name	Definition	Solution
		open while in motion. Enabled with 01-159.	
631	DO During Run	Debugging alarm signaling that DO output asserted during a run. Will not flag if decelerating, in stop sequence, or releveling.	NA
632	In Dest DZ During Run	Debugging alarm signaling that the flag preventing DO is being lost during a run. Will not flag if decelerating, in stop sequence, or releveling.	NA
1535	Normal Limit Reached	The car has reached the normal limits of either the bottom or top door zone.	Move the car away from the Normal Limit.

43.4.3 Fire

The table below lists the alarms related to Fire.

Table 77: List of Alarms related to Fire

Fault Number	Name	Definition	Solution
1423	Fire Key Main	Fire phase 1 has been activated by the main fire key switch.	Check the fire input and riser board status.
1424	Fire Key Remote	Fire phase 1 has been activated by the remote fire key switch.	Check the fire input and riser board status.
1425	Fire Smoke Main	Fire phase 1 has been activated by the main smoke input.	Check the fire input and riser board status.
1426	Fire Smoke Alt	Fire phase 1 has been activated by the alternate smoke input.	Check the fire input and riser board status.
1427	Fire Smoke MR	Fire phase 1 has been activated by the machine room smoke input.	Check the fire input and riser board status.
1428	Fire Smoke HA	Fire phase 1 has been activated by the hoistway smoke input.	Check the fire input and riser board status.
1429	Fire Smoke Latched	Fire phase 1 has been activated by a latched fire recall source following a power loss.	Check the fire input and riser board status.
1430	Fire Smoke Pit	Fire phase 1 has been activated by the pit smoke input.	Check the fire input and riser board status.

Fault Number	Name	Definition	Solution
1431	Fire Smoke MR 2	Fire phase 1 has been activated by the second machine room smoke input.	Check the fire input and riser board status.
1432	Fire Smoke HA 2	Fire phase 1 has been activated by the second hoistway smoke input.	Check the fire input and riser board status.
1455	Fire Virtual Remote Recall	Fire phase 1 has been activated by Virtual Input Fire Remote Recall	NA
1521	Fire2 Hold	If the car is on fire phase 2 operation, and not at the recall floor. When the in car fire key switch is turned to the OFF position, the car will be put in a Fire Phase 2 Hold state if option Fire_Phase2ExitOnlyAtRecallFlr (01-0017) is ON. This alarm informs the user that they should move the car back to the recall floor before attempting to exit phase 2.	Return the car to the recall floor before exiting phase 2.

43.4.4 Floors

The table below lists the alarms related to Floors.

Table 78: List of Alarms related to Floors

Fault Number	Name	Definition	Solution
78	Releveling	Car is performing releveling.	NA
85	Recall Inv Floor	Requested recall destination is an invalid floor.	NA
86	Recall Inv Opening	Requested recall destination is not a valid opening.	NA
122	Inv Man Run HA	Manual run request rejected due to invalid hoistway access floor or opening configuration.	NA
1522	RCL MOVE	The car has attempted to move to a recall floor but	This alarm is for diagnostics and does not require immediate Smartrise support unless

Fault Number	Name	Definition	Solution
		failed to start movement within 5 seconds.	accompanied by other recall related issues.

43.4.5 Landing System

The table below lists the alarms related to Landing System.

Table 79: List of Alarms related to Landing System

Fault Number	Name	Definition	Solution
1462	CEDES1 COMM	Primary CEDES camera channel 1 reporting a communication error.	Check wiring and network termination.
1463	CEDES1 READ	Primary CEDES camera channel 1 reporting a cannot read tape error.	Clean camera window, clean tape, check alignment.
1464	CEDES1 CLOSE	Primary CEDES camera channel 1 reporting a tape too close error.	Fix tape alignment.
1465	CEDES1 FAR	Primary CEDES camera channel 1 reporting a tape too far error.	Fix tape alignment.
1466	CEDES1 LEFT	Primary CEDES camera channel 1 reporting a tape too far left error.	Fix tape alignment.
1467	CEDES1 RIGHT	Primary CEDES camera channel 1 reporting a tape too far right error.	Fix tape alignment.
1468	CEDES1 CONTRAST1	Primary CEDES camera channel 1 reporting a contrast - service recommended read status.	Clean camera window, clean tape, check alignment.
1469	CEDES1 CONTRAST2	Primary CEDES camera channel 1 reporting a contrast - warning read status.	Clean camera window, clean tape, check alignment.
1470	CEDES1 CONTRAST3	Primary CEDES camera channel 1 reporting a contrast - stopped read status.	Clean camera window, clean tape, check alignment.
1471	CEDES1 CRC	Primary CEDES camera channel 1 failed CRC check.	Check wiring and network termination.

Fault Number	Name	Definition	Solution
1472	CEDES2 COMM	Primary CEDES camera channel 2 reporting a communication error.	Check wiring and network termination.
1473	CEDES2 READ	Primary CEDES camera channel 2 reporting a cannot read tape error.	Clean camera window, clean tape, check alignment.
1474	CEDES2 CLOSE	Primary CEDES camera channel 2 reporting a tape too close error.	Fix tape alignment.
1475	CEDES2 FAR	Primary CEDES camera channel 2 reporting a tape too far error.	Fix tape alignment.
1476	CEDES2 LEFT	Primary CEDES camera channel 2 reporting a tape too far left error.	Fix tape alignment.
1477	CEDES2 RIGHT	Primary CEDES camera channel 2 reporting a tape too far right error.	Fix tape alignment.
1478	CEDES2 CONTRAST1	Primary CEDES camera channel 2 reporting a contrast - service recommended read status.	Clean camera window, clean tape, check alignment.
1479	CEDES2 CONTRAST2	Primary CEDES camera channel 2 reporting a contrast - warning read status.	Clean camera window, clean tape, check alignment.
1480	CEDES2 CONTRAST3	Primary CEDES camera channel 2 reporting a contrast - stopped read status.	Clean camera window, clean tape, check alignment.
1481	CEDES2 CRC	Primary CEDES camera channel 2 failed CRC check.	Check wiring and network termination.
1482	CEDES3 COMM	ETSL CEDES camera channel 2 reporting a communication error.	Check wiring and network termination.
1483	CEDES3 READ	ETSL CEDES camera channel 2 reporting a cannot read tape error.	Clean camera window, clean tape, check alignment.

Fault Number	Name	Definition	Solution
1484	CEDES3 CLOSE	ETSL CEDES camera channel 2 reporting a tape too close error.	Fix tape alignment.
1485	CEDES3 FAR	ETSL CEDES camera channel 2 reporting a tape too far error.	Fix tape alignment.
1486	CEDES3 LEFT	ETSL CEDES camera channel 2 reporting a tape too far left error.	Fix tape alignment.
1487	CEDES3 RIGHT	ETSL CEDES camera channel 2 reporting a tape too far right error.	Fix tape alignment.
1488	CEDES3 CONTRAST1	ETSL CEDES camera channel 2 reporting a contrast - service recommended read status.	Clean camera window, clean tape, check alignment.
1489	CEDES3 CONTRAST2	ETSL CEDES camera channel 2 reporting a contrast - warning read status.	Clean camera window, clean tape, check alignment.
1490	CEDES3 CONTRAST3	ETSL CEDES camera channel 2 reporting a contrast - stopped read status.	Clean camera window, clean tape, check alignment.
1491	CEDES3 CRC	ETSL CEDES camera channel 2 failed CRC check.	Check wiring and network termination.

43.4.6 Load Weighing Device

The table below lists the alarms related to Load Weighing Device.

Table 80: List of Alarms related to Load Weighing Device

Fault Number	Name	Definition	Solution
1417	LWD Offline	Communication with load weighing device has been lost.	Check the status of the smart rise load weigher. If no load weigher exists, set load weigher select (08-135) to zero.
1524	LWD UNK	Serial load weighing device reporting an unknown error.	Check wiring of the serial load weighing device.

Fault Number	Name	Definition	Solution
1525	LWD POR	Serial load weighing device reporting a powering on reset error.	Check serial load weighing device's power supply.
1526	LWD WDT	Serial load weighing device reporting a watchdog reset error.	Contact Smartrise support.
1527	LWD BOD	Serial load weighing device reporting a brown out reset error.	Check serial load weighing device's power supply.
1528	LWD COM SYS	Serial load weighing device reporting no communication with the C4 system detected.	Check wiring of serial load weighing device's CAN H and CAN L.
1529	LWD COM LOAD	Serial load weighing device reporting no communication detected with load cell processor.	Contact Smartrise support.
1530	LWD CAN BUS RST	Serial load weighing device reporting the can bus controller has reset.	Check wiring of serial load weighing device's CAN H and CAN L.
1531	LWD WD DISA	Serial load weighing device reporting the watchdog is disabled.	Check on board watchdog jumper.

43.4.7 Miscellaneous

The table below lists the alarms under Miscellaneous.

Table 81: List of Alarms under Miscellaneous

Fault Number	Name	Definition	Solution
69	ES Class Op	When 01-150 is set to ON, this debugging alarm will signal when an ESTOP is commanded due to class of operation change.	NA
1417	LWD Offline	Communication with load weighing device has been lost.	Check the status of the smart rise load weigher. If no load weigher exists, set load weigher select (08-135) to zero.
70	ES Stop Timeout	When 01-150 is set to ON, this debugging alarm	NA

Fault Number	Name	Definition	Solution
		will signal when an ESTOP is commanded due to run flag failing to drop.	
71	ES Move Timeout	When 01-150 is set to ON, this debugging alarm will signal when an ESTOP is commanded due to failing to start a run.	NA
72	ES Inv Insp	When 01-150 is set to ON, this debugging alarm will signal when an ESTOP is commanded due to invalid inspection mode.	NA
73	ES Recall Dest.	When 01-150 is set to ON, this debugging alarm will signal when an ESTOP is commanded due to invalid recall destination.	NA
74	ES Stop At Next	When 01-130 is set to ON, this debugging alarm will signal when the car is commanded to stop at next available floor.	NA
75	ES Earthquake	When 01-150 is set to ON, this debugging alarm will signal when an ESTOP is during EQ operation.	NA
76	ES Flood	When 01-150 is set to ON, this debugging alarm will signal when an ESTOP is during flood operation.	NA
87	MRA WDT Disabled	Processor has started up with watchdog disabled.	Remove the WD jumper and restart the board to reenale.
88	MRB WDT Disabled	Processor has started up with watchdog disabled.	Remove the WD jumper and restart the board to reenale.

Fault Number	Name	Definition	Solution
89	CTA WDT Disabled	Processor has started up with watchdog disabled.	Remove the WD jumper and restart the board to reenable.
90	CTB WDT Disabled	Processor has started up with watchdog disabled.	Remove the WD jumper and restart the board to reenable.
91	COPA WDT Disabled	Processor has started up with watchdog disabled.	Remove the WD jumper and restart the board to reenable.
92	COPB WDT Disabled	Processor has started up with watchdog disabled.	Remove the WD jumper and restart the board to reenable.
93 - 96	MR CAN Rst 1-4	Machine room SRU CAN1-4 transceiver has self-reset due to excessive bus errors.	Verify bus wiring. If problem persists, remove boards from the network to isolate the board with the problem transceiver.
97 - 100	CT CAN Rst 1-4	Car top SRU CAN1-4 transceiver has self-reset due to excessive bus errors.	Verify bus wiring. If problem persists, remove boards from the network to isolate the board with the problem transceiver.
101 - 104	COP CAN Rst 1-4	Car operating panel SRU CAN1-4 transceiver has self-reset due to excessive bus errors.	Verify bus wiring. If problem persists, remove boards from the network to isolate the board with the problem transceiver.
105	Drive Rst	Car is triggering a drive fault reset.	NA
106	Drive Rst Limit	Drive reset limit has been reached. The controller will no longer reset drive faults.	NA
107	Fully Loaded	The car is fully loaded and will no longer take hall calls.	NA
113	Remote PU Mag	The car has received a remote request to change a magnetek drive parameter.	NA
114	Remote PU KEB	The car has received a remote request to change a KEB drive parameter.	NA
123	Inv Man Run CT En	Manual run request rejected due to missing CT enable signal.	NA
124	Idle Dir Timeout	Car has been idle with a valid destination for the user configured timeout	124

Fault Number	Name	Definition	Solution
		(08-202) and has been forced to change direction.	
128	No Dest Stop	The car is in motion, but its destination has been canceled. There are no reachable alternative destinations. It will ramp down at the next available landing and reassess. This can occur in cases where a hall call is reassigned to a closer car. This will not occur if 01-00196 is ON.	128
129	Flood Switch	The flood switch has been activated.	129
131	Dup EP InterGroup	A Duplicate Group Priority was Detected	NA
132 - 139	I-Group 1-8 No Connection	Connection was lost for Inter Group 1-8	NA
140	I-Group0 Stat Rcvd	Intergroup status packet received by group with priority 0.	NA
141	CCB Secured	Pressed Car Call Button is secured.	Check security options to verify if the CCB should or should not be secured.
144	LWD Load Learn	C4 load weighing device is performing a load learn at each landing.	NA
145	LWD Recalibrate	C4 load weighing device is performing an empty car learn at each landing.	NA
146	Mode Changed	When 01-129 is ON, this debug alarm will be set when the mode of operation changes.	NA
207 - 214	Dispatch T/O C1-8	NA	NA
215 - 222	Dispatch T/O X1-8	NA	NA
223 - 230	XREG Offline 1-8	NA	NA

Fault Number	Name	Definition	Solution
232 - 298	MRA RT M1-67	Module runtime limit exceeded for module index 1-67.	NA
299 - 362	MRB RT M1-64	Module runtime limit exceeded for module index 1-64.	NA
363 - 427	CTA RT M1-65	Module runtime limit exceeded for module index 1-65.	NA
428 - 491	CTB RT M1-64	Module runtime limit exceeded for module index 1-64.	NA
492 - 555	COPA RT M1-64	Module runtime limit exceeded for module index 164.	NA
556 - 619	COPB RT M1-64	Module runtime limit exceeded for module index 1-64.	NA
620 - 627	Car Offline 1-8	NA	NA
628	DDM Offline	DD Panel manager board has gone offline.	Check DD manager board wiring.
630	FRAM Redundancy	FRAM's data redundancy check has failed, but the data was recovered.	NA
633 - 640	Dupl. MR 501-508	Specified terminal exceeds the two-duplicate limit per input function.	Clear the terminal's function.
641 - 656	Dupl. CT 501-516	Specified terminal exceeds the two-duplicate limit per input function.	Clear the terminal's function.
657 - 672	Dupl. COP 501 - 516	Specified terminal exceeds the two-duplicate limit per input function.	Clear the terminal's function.
673 - 680	Dupl. RIS1 501 - 508	Specified terminal exceeds the two-duplicate limit per input function.	Clear the terminal's function.
681 - 688	Dupl. RIS2 501 - 508	Specified terminal exceeds the two-	Clear the terminal's function.

Fault Number	Name	Definition	Solution
		duplicate limit per input function.	
689 - 696	Dupl. RIS3 501 - 508	Specified terminal exceeds the two-duplicate limit per input function.	Clear the terminal's function.
697 - 704	Dupl. RIS4 501 - 508	Specified terminal exceeds the two-duplicate limit per input function.	Clear the terminal's function.
705 - 712	Dupl. EXP1 501 - 508	Specified terminal exceeds the two-duplicate limit per input function.	Clear the terminal's function.
713 - 720	Dupl. EXP2 501 - 508	Specified terminal exceeds the two-duplicate limit per input function.	Clear the terminal's function.
721 - 728	Dupl. EXP3 501 - 508	Specified terminal exceeds the two-duplicate limit per input function.	Clear the terminal's function.
729 - 736	Dupl. EXP4 501 - 508	Specified terminal exceeds the two-duplicate limit per input function.	Clear the terminal's function.
737 - 744	Dupl. EXP5 501 - 508	Specified terminal exceeds the two-duplicate limit per input function.	Clear the terminal's function.
745 - 752	Dupl. EXP6 501 - 508	Specified terminal exceeds the two-duplicate limit per input function.	Clear the terminal's function.
753 - 760	Dupl. EXP7 501 - 508	Specified terminal exceeds the two-duplicate limit per input function.	Clear the terminal's function.
761 - 768	Dupl. EXP8 501 - 508	Specified terminal exceeds the two-duplicate limit per input function.	Clear the terminal's function.

Fault Number	Name	Definition	Solution
769 - 776	Dupl. EXP9 501 - 508	Specified terminal exceeds the two-duplicate limit per input function.	Clear the terminal's function.
777 - 784	Dupl. EXP10 501 - 508	Specified terminal exceeds the two-duplicate limit per input function.	Clear the terminal's function.
785 - 792	Dupl. EXP11 501 - 508	Specified terminal exceeds the two-duplicate limit per input function.	Clear the terminal's function.
793 - 800	Dupl. EXP12 501 - 508	Specified terminal exceeds the two-duplicate limit per input function.	Clear the terminal's function.
801 - 808	Dupl. EXP13 501 - 508	Specified terminal exceeds the two-duplicate limit per input function.	Clear the terminal's function.
809 - 816	Dupl. EXP14 501 - 508	Specified terminal exceeds the two-duplicate limit per input function.	Clear the terminal's function.
817 - 824	Dupl. EXP15 501 - 508	Specified terminal exceeds the two-duplicate limit per input function.	Clear the terminal's function.
825 - 832	Dupl. EXP16 501 - 508	Specified terminal exceeds the two-duplicate limit per input function.	Clear the terminal's function.
833 - 840	Dupl. EXP17 501 - 508	Specified terminal exceeds the two-duplicate limit per input function.	Clear the terminal's function.
841 - 848	Dupl. EXP18 501 - 508	Specified terminal exceeds the two-duplicate limit per input function.	Clear the terminal's function.
849 - 856	Dupl. EXP19 501 - 508	Specified terminal exceeds the two-	Clear the terminal's function.

Fault Number	Name	Definition	Solution
		duplicate limit per input function.	
857 - 864	Dupl. EXP20 501 - 508	Specified terminal exceeds the two-duplicate limit per input function.	Clear the terminal's function.
865 - 872	Dupl. EXP21 501 - 508	Specified terminal exceeds the two-duplicate limit per input function.	Clear the terminal's function.
873 - 880	Dupl. EXP22 501 - 508	Specified terminal exceeds the two-duplicate limit per input function.	Clear the terminal's function.
881 - 888	Dupl. EXP23 501 - 508	Specified terminal exceeds the two-duplicate limit per input function.	Clear the terminal's function.
889 - 896	Dupl. EXP24 501 - 508	Specified terminal exceeds the two-duplicate limit per input function.	Clear the terminal's function.
897 - 904	Dupl. EXP25 501 - 508	Specified terminal exceeds the two-duplicate limit per input function.	Clear the terminal's function.
905 - 912	Dupl. EXP26 501 - 508	Specified terminal exceeds the two-duplicate limit per input function.	Clear the terminal's function.
913 - 920	Dupl. EXP27 501 - 508	Specified terminal exceeds the two-duplicate limit per input function.	Clear the terminal's function.
921 - 928	Dupl. EXP28 501 - 508	Specified terminal exceeds the two-duplicate limit per input function.	Clear the terminal's function.
929 - 936	Dupl. EXP29 501 - 508	Specified terminal exceeds the two-duplicate limit per input function.	Clear the terminal's function.

Fault Number	Name	Definition	Solution
937 - 944	Dupl. EXP30 501 - 508	Specified terminal exceeds the two-duplicate limit per input function.	Clear the terminal's function.
945 - 952	Dupl. EXP31 501 - 508	Specified terminal exceeds the two-duplicate limit per input function.	Clear the terminal's function.
953 - 960	Dupl. EXP32 501 - 508	Specified terminal exceeds the two-duplicate limit per input function.	Clear the terminal's function.
961 - 968	Dupl. EXP33 501 - 508	Specified terminal exceeds the two-duplicate limit per input function.	Clear the terminal's function.
969 - 976	Dupl. EXP34 501 - 508	Specified terminal exceeds the two-duplicate limit per input function.	Clear the terminal's function.
977 - 984	Dupl. EXP35 501 - 508	Specified terminal exceeds the two-duplicate limit per input function.	Clear the terminal's function.
985 - 992	Dupl. EXP36 501 - 508	Specified terminal exceeds the two-duplicate limit per input function.	Clear the terminal's function.
993 - 1000	Dupl. EXP37 501 - 508	Specified terminal exceeds the two-duplicate limit per input function.	Clear the terminal's function.
1001 - 1008	Dupl. EXP38 501 - 508	Specified terminal exceeds the two-duplicate limit per input function.	Clear the terminal's function.
1009 - 1016	Dupl. EXP39 501 - 508	Specified terminal exceeds the two-duplicate limit per input function.	Clear the terminal's function.
1017 - 1024	Dupl. EXP40 501 - 508	Specified terminal exceeds the two-	Clear the terminal's function.

Fault Number	Name	Definition	Solution
		duplicate limit per input function.	
1025 - 1032	Dupl. MR 601 - 608	Specified terminal exceeds the two-duplicate limit per output function.	Clear the terminal's function.
1033 - 1048	Dupl. CT 601 - 616	Specified terminal exceeds the two-duplicate limit per output function.	Clear the terminal's function.
1049 - 1064	Dupl. COP 601 - 616	Specified terminal exceeds the two-duplicate limit per output function.	Clear the terminal's function.
1065 - 1072	Dupl. RIS1 601 - 608	Specified terminal exceeds the two-duplicate limit per output function.	Clear the terminal's function.
1073 - 1080	Dupl. RIS2 601 - 608	Specified terminal exceeds the two-duplicate limit per output function.	Clear the terminal's function.
1081 - 1088	Dupl. RIS3 601 - 608	Specified terminal exceeds the two-duplicate limit per output function.	Clear the terminal's function.
1089 - 1096	Dupl. RIS4 601 - 608	Specified terminal exceeds the two-duplicate limit per output function.	Clear the terminal's function.
1097 - 1104	Dupl. EXP1 601 - 608	Specified terminal exceeds the two-duplicate limit per output function.	Clear the terminal's function.
1105 - 1112	Dupl. EXP2 601 - 608	Specified terminal exceeds the two-duplicate limit per output function.	Clear the terminal's function.
1113 - 1120	Dupl. EXP3 601 - 608	Specified terminal exceeds the two-duplicate limit per output function.	Clear the terminal's function.

Fault Number	Name	Definition	Solution
1121 - 1128	Dupl. EXP4 601 - 608	Specified terminal exceeds the two-duplicate limit per output function.	Clear the terminal's function.
1129 - 1136	Dupl. EXP5 601 - 608	Specified terminal exceeds the two-duplicate limit per output function.	Clear the terminal's function.
1137 - 1144	Dupl. EXP6 601 - 608	Specified terminal exceeds the two-duplicate limit per output function.	Clear the terminal's function.
1145 - 1152	Dupl. EXP7 601 - 608	Specified terminal exceeds the two-duplicate limit per output function.	Clear the terminal's function.
1153 - 1160	Dupl. EXP8 601 - 608	Specified terminal exceeds the two-duplicate limit per output function.	Clear the terminal's function.
1161 - 1168	Dupl. EXP9 601 - 608	Specified terminal exceeds the two-duplicate limit per output function.	Clear the terminal's function.
1169 - 1176	Dupl. EXP10 601 - 608	Specified terminal exceeds the two-duplicate limit per output function.	Clear the terminal's function.
1177 - 1184	Dupl. EXP11 601 - 608	Specified terminal exceeds the two-duplicate limit per output function.	Clear the terminal's function.
1185 - 1192	Dupl. EXP12 601 - 608	Specified terminal exceeds the two-duplicate limit per output function.	Clear the terminal's function.
1193 - 1200	Dupl. EXP13 601 - 608	Specified terminal exceeds the two-duplicate limit per output function.	Clear the terminal's function.
1201 - 1208	Dupl. EXP14 601 - 608	Specified terminal exceeds the two-	Clear the terminal's function.

Fault Number	Name	Definition	Solution
		duplicate limit per output function.	
1209 - 1216	Dupl. EXP15 601 - 608	Specified terminal exceeds the two-duplicate limit per output function.	Clear the terminal's function.
1217 - 1224	Dupl. EXP16 601 - 608	Specified terminal exceeds the two-duplicate limit per output function.	Clear the terminal's function.
1225 - 1232	Dupl. EXP17 601 - 608	Specified terminal exceeds the two-duplicate limit per output function.	Clear the terminal's function.
1233 - 1240	Dupl. EXP18 601 - 608	Specified terminal exceeds the two-duplicate limit per output function.	Clear the terminal's function.
1241 - 1248	Dupl. EXP19 601 - 608	Specified terminal exceeds the two-duplicate limit per output function.	Clear the terminal's function.
1249 - 1256	Dupl. EXP20 601 - 608	Specified terminal exceeds the two-duplicate limit per output function.	Clear the terminal's function.
1257 - 1264	Dupl. EXP21 601 - 608	Specified terminal exceeds the two-duplicate limit per output function.	Clear the terminal's function.
1265 - 1272	Dupl. EXP22 601 - 608	Specified terminal exceeds the two-duplicate limit per output function.	Clear the terminal's function.
1273 - 1280	Dupl. EXP23 601 - 608	Specified terminal exceeds the two-duplicate limit per output function.	Clear the terminal's function.
1281 - 1288	Dupl. EXP24 601 - 608	Specified terminal exceeds the two-duplicate limit per output function.	Clear the terminal's function.

Fault Number	Name	Definition	Solution
1289 - 1296	Dupl. EXP25 601 - 608	Specified terminal exceeds the two-duplicate limit per output function.	Clear the terminal's function.
1297 - 1304	Dupl. EXP26 601 - 608	Specified terminal exceeds the two-duplicate limit per output function.	Clear the terminal's function.
1305 - 1312	Dupl. EXP27 601 - 608	Specified terminal exceeds the two-duplicate limit per output function.	Clear the terminal's function.
1313 - 1320	Dupl. EXP28 601 - 608	Specified terminal exceeds the two-duplicate limit per output function.	Clear the terminal's function.
1321 - 1328	Dupl. EXP29 601 - 608	Specified terminal exceeds the two-duplicate limit per output function.	Clear the terminal's function.
1329 - 1336	Dupl. EXP30 601 - 608	Specified terminal exceeds the two-duplicate limit per output function.	Clear the terminal's function.
1337 - 1344	Dupl. EXP31 601 - 608	Specified terminal exceeds the two-duplicate limit per output function.	Clear the terminal's function.
1345 - 1352	Dupl. EXP32 601 - 608	Specified terminal exceeds the two-duplicate limit per output function.	Clear the terminal's function.
1353 - 1360	Dupl. EXP33 601 - 608	Specified terminal exceeds the two-duplicate limit per output function.	Clear the terminal's function.
1361 - 1368	Dupl. EXP34 601 - 608	Specified terminal exceeds the two-duplicate limit per output function.	Clear the terminal's function.
1369 - 1376	Dupl. EXP35 601 - 608	Specified terminal exceeds the two-	Clear the terminal's function.

Fault Number	Name	Definition	Solution
		duplicate limit per output function.	
1377 - 1384	Dupl. EXP36 601 - 608	Specified terminal exceeds the two-duplicate limit per output function.	Clear the terminal's function.
1385 - 1392	Dupl. EXP37 601 - 608	Specified terminal exceeds the two-duplicate limit per output function.	Clear the terminal's function.
1393 - 1400	Dupl. EXP38 601 - 608	Specified terminal exceeds the two-duplicate limit per output function.	Clear the terminal's function.
1401 - 1408	Dupl. EXP39 601 - 608	Specified terminal exceeds the two-duplicate limit per output function.	Clear the terminal's function.
1409 - 1416	Dupl. EXP40 601 - 608	Specified terminal exceeds the two-duplicate limit per output function.	Clear the terminal's function.
1418	DL20 Offline CT	Communication with DL20 fixture and car top SRU has been lost.	Check wiring and power to DL20.
1419	DL20 Offline COP	Communication with DL20 fixture and car operating panel SRU has been lost.	Check wiring and power to DL20.
1433	NEED TO RST MR	Machine room SRU board needs to be reset.	Cycle power to the machine room SRU board.
1434	NEED TO RST CT	Car top SRU board needs to be reset.	Cycle power to the car top SRU board.
1435	NEED TO RST COP	Car operating panel SRU board needs to be reset.	Cycle power to the car operating panel SRU board.
1436	Unint. Mov. Test Active	Unintended movement test feature is active. If not intended, turn OFF MR SRU DIP B8 and parameter 01-0052 to disable the feature.	Unintended movement test feature is active. If not intended, turn OFF MR SRU DIP B8 and parameter 01-0052 to disable the feature.

Fault Number	Name	Definition	Solution
1437	Dupar COP Offline	Communication has been lost between Dupar COP and COP SRU.	Check wiring between Dupar COP and COP SRU (C3H/C3L)
1442	Shield Unknown	Shield error state is unknown.	Check wiring of power and network lines.
1443	Shield POR Rst	Shield is starting up after a standard reset event.	Check wiring of power and network lines.
1444	Shield BOD Rst	Shield is starting up after a brown out reset event.	Check wiring of power and network lines.
1445	Shield WDT Rst	Shield is starting up after a watchdog timer reset event.	Check wiring of power and network lines.
1446	Shield COM Group	Shield has not seen communication from the group network in 5 seconds.	Check wiring of power and network lines.
1447	Shield COM RPi	Shield has not seen communication from the RPi in 5 seconds.	Check wiring of power and network lines.
1448	Shield Failed RTC	Shield RTC has failed.	Replace on board battery.
1449	Shield UART OVF TX	Shield UART transmit buffer has overflowed.	Contact smartrise support.
1450	Shield UART OVF RX	Shield UART receive buffer has overflowed.	Contact smartrise support.
1451	Shield CAN OVF TX	Shield CAN transmit buffer has overflowed.	Contact smartrise support.
1452	Shield CAN OVF RX	Shield CAN receive buffer has overflowed.	Contact smartrise support.
1453	Shield CAN Bus Rst	Shield has detected a can bus reset event.	Check wiring of power and network lines.
1454	VIP Timeout	VIP process has been canceled due to excessive wait time.	NA
1456	EMS2 Not At Recall	Car is on EMS phase 2, in a dead zone with doors open, but can't exit EMS 2 because it is not at the correct recall floor (the floor it was first called to on EMS phase 1).	Either move car to the correct EMS 1 recall floor or turn ON parameter EMS_ExitPh2AtAnyFloor (01-98) to allow exiting EMS phase 2 at any floor.

Fault Number	Name	Definition	Solution
1492	DAD Offline	DAD unit has stopped communicating with the C4 car for 15 seconds.	Check group network wiring. Check that power is supplied to the DAD unit.
1493	SS Offline	Communication lost with primary soft starter.	(Hydro Only) Check primary soft starter board and wiring.
1494	SS Unk	Primary soft starter reporting an unknown fault.	(Hydro Only) Check primary soft starter board and wiring.
1495	SS POR Rst	Primary soft starter recovering from a reset due to power off.	(Hydro Only) Check primary soft starter board and wiring.
1496	SS WDT Rst	Primary soft starter recovering from reset due to watchdog.	(Hydro Only) Check primary soft starter board and wiring.
1497	SS BOD Rst	Primary soft starter recovering from reset due to voltage dip.	(Hydro Only) Check primary soft starter board and wiring.
1498	SS Comm Loss	Primary soft starter reporting loss of communication with the elevator controller.	(Hydro Only) Check primary soft starter board and wiring.
1499	SS OC	Primary soft starter reporting an overcurrent error.	(Hydro Only) Check primary soft starter board and wiring.
1500	SS OVV	Primary soft starter reporting an overvoltage error.	(Hydro Only) Check primary soft starter board and wiring.
1501	SS UNDV	Primary soft starter reporting an undervoltage error.	(Hydro Only) Check primary soft starter board and wiring.
1502	SS Phase Miss	Primary soft starter reporting a missing phase.	(Hydro Only) Check primary soft starter board and wiring.
1503	SS Phase Seq	Primary soft starter reporting phase sequence error.	(Hydro Only) Check primary soft starter board and wiring.
1504	SS CAN Bus Rst	Primary soft starter reporting a CAN bus reset.	(Hydro Only) Check primary soft starter board and wiring.
1505	SS Input Flt	Discrete input fault 2 from the Soft Starter has been activated.	(Hydro Only) Check the SS 2 Input fault, and the contact feeding the input from the drive.

Fault Number	Name	Definition	Solution
1506	SS2 Offline	Communication lost with secondary soft starter.	(Hydro Only) Check secondary soft starter board and wiring.
1507	SS2 Unk	Secondary soft starter reporting an unknown fault.	(Hydro Only) Check secondary soft starter board and wiring.
1508	SS2 POR Rst	Secondary soft starter recovering from a reset due to power off.	(Hydro Only) Check secondary soft starter board and wiring.
1509	SS2 WDT Rst	Secondary soft starter recovering from reset due to watchdog.	(Hydro Only) Check secondary soft starter board and wiring.
1510	SS2 BOD Rst	Secondary soft starter recovering from reset due to voltage dip.	(Hydro Only) Check secondary soft starter board and wiring.
1511	SS2 Comm Loss	Secondary soft starter reporting loss of communication with the elevator controller.	(Hydro Only) Check secondary soft starter board and wiring.
1512	SS2 OC	Secondary soft starter reporting an overcurrent error.	(Hydro Only) Check secondary soft starter board and wiring.
1513	SS2 OVV	Secondary soft starter reporting an overvoltage error.	(Hydro Only) Check secondary soft starter board and wiring.
1514	SS2 UNDV	Secondary soft starter reporting an undervoltage error.	(Hydro Only) Check secondary soft starter board and wiring.
1515	SS2 Phase Miss	Secondary soft starter reporting a missing phase.	(Hydro Only) Check secondary soft starter board and wiring.
1516	SS2 Phase Seq	Secondary soft starter reporting phase sequence error.	(Hydro Only) Check secondary soft starter board and wiring.
1517	SS2 CAN Bus Rst	Secondary soft starter reporting a CAN bus reset.	(Hydro Only) Check secondary soft starter board and wiring.
1518	SS2 Input Flt	Discrete input fault 2 from the Soft Starter has been activated.	(Hydro Only) Check the SS 2 Input fault, and the contact feeding the input from the drive.
1519	SS ADDR	Primary soft starter reporting another board	(Hydro Only) Check primary soft starter address DIP switches.

Fault Number	Name	Definition	Solution
		on the network has the same address.	
1520	SS2 ADDR	Secondary soft starter reporting another board on the network has the same address.	(Hydro Only) Check secondary soft starter address DIP switches.
1532	CAN1 OVF MRA	The CAN1 buffer on MRA has overflowed. Investigate CN1 +/- network issues.	Check CN1 +/- network wiring and termination.
1533	CAN1 OVF CTA	The CAN1 buffer on CTA has overflowed. Investigate CN1 +/- network issues.	Check CN1 +/- network wiring and termination.
1534	CAN1 OVF COPA	The CAN1 buffer on COPA has overflowed. Investigate CN1 +/- network issues.	Check CN1 +/- network wiring and termination.
1536	Touchscreen Offline	Communication has been lost between Touchscreen/COP and COP SRU.	Check wiring between Touchscreen/COP and COP SRU (C3H/C3L)
1538	SS3 Input Flt	Discrete input fault 3 from the Soft Starter has been activated.	(Hydro Only) Check the SS 2 Input fault, and the contact feeding the input from the drive.
1539	CC Button Stuck Active	A car call button is stuck active while not pressed down	Check whether any car call button is experiencing an input stuck on condition while the button is not being actively pressed.
1540	FINAL Limit Bypassed	BFL or TFL is bypassed	Check if BFL/TFL is connected directly to 120VAC and wire it through the BFL/TFL switch
1541	Phone Failure	Phone failure input has been activated.	Check phone failure input wiring.
1542	Phase Fault Input	Phase fault input has been activated on learn and manual classes of operation	Check Phase fault input

43.4.8 Parameters

The table below lists the alarms related to Parameters.

Table 82: List of Alarms related to Parameters

Fault Number	Name	Definition	Solution
79	Defaulting 1-Bit	Defaulting 1-bit parameters.	NA
80	Defaulting 8-Bit	Defaulting 8-bit parameters.	NA
81	Defaulting 16-Bit	Defaulting 16-bit parameters.	NA
82	Defaulting 24-Bit	Defaulting 24-bit parameters.	NA
83	Defaulting 32-Bit	Defaulting 32-bit parameters.	NA
108	Remote PU 1-Bit	The car has received a remote request to change a 1-bit parameter.	NA
109	Remote PU 8-Bit	The car has received a remote request to change a 8-bit parameter.	NA
110	Remote PU 16-Bit	The car has received a remote request to change a 16-bit parameter.	NA
111	Remote PU 24-Bit	The car has received a remote request to change a 24-bit parameter.	NA
112	Remote PU 32-Bit	The car has received a remote request to change a 32-bit parameter.	NA
130	Remote PU Backup	The car has received a remote request to change parameters in a bulk parameter restore format.	NA
1537	HB Configuration	This alarm appears when Param. 01-0195 and Param. 01-0225 aren't equal.	Review parameter 01-0195 and 01-0225

43.4.9 Riser Boards

The table below lists the alarms related to Riser Boards.

Table 83: List of Alarms related to Riser Boards

Fault Number	Name	Definition	Solution
147	RIS1 Offline	Riser1 marked as offline after 30 seconds without communication.	NA
148	RIS1 Unk	Riser1 reporting an unknown error.	NA
149	RIS1 POR Rst	Riser1 reporting a power-on reset error.	NA
150	RIS1 WDT Rst	Riser1 reporting a watchdog reset error.	NA
151	RIS1 BOD Rst	Riser1 reporting a brown-out reset error.	NA
152	RIS1 Group Net	Riser1 reporting a group network communication loss error.	NA
153	RIS1 Hall Net	Riser1 reporting a hall network communication loss error.	NA
154	RIS1 Car Net	Riser1 reporting an invalid error.	NA
155	RIS1 Mst Net	Riser1 reporting an invalid error.	NA
156	RS1 Slv Net	Riser1 reporting an invalid error.	NA
157	RIS1 DIP	Riser1 has detected another board with the same address.	NA
158	RIS1 Bus Rst 1	Riser1 reporting a CAN1 bus reset error.	NA
159	RIS1 Bus Rst 2	Riser1 reporting a CAN2 bus reset error.	NA
160	RIS1 Inv Msg 1	NA	NA
161	RIS1 Inv Msg 2	NA	NA
162	RIS2 Offline	Riser2 marked as offline after 30 seconds without communication.	NA
163	RIS2 Unk	Riser2 reporting an unknown error.	NA
164	RIS2 POR Rst	Riser2 reporting a power-on reset error.	NA
165	RIS2 WDT Rst	Riser2 reporting a watchdog reset error.	NA

Fault Number	Name	Definition	Solution
166	RIS2 BOD Rst	Riser2 reporting a brown-out reset error.	NA
167	RIS2 Group Net	Riser2 reporting a group network communication loss error.	NA
168	RIS2 Hall Net	Riser2 reporting a hall network communication loss error.	NA
169	RIS2 Car Net	Riser2 reporting an invalid error.	NA
170	RIS2 Mst Net	Riser2 reporting an invalid error.	NA
171	RS1 Slv Net	Riser2 reporting an invalid error.	NA
172	RIS2 DIP	Riser2 has detected another board with the same address.	NA
173	RIS2 Bus Rst 1	Riser2 reporting a CAN1 bus reset error.	NA
174	RIS2 Bus Rst 2	Riser2 reporting a CAN2 bus reset error.	NA
175	RIS2 Inv Msg 1	NA	NA
176	RIS2 Inv Msg 2	NA	NA
177	RIS3 Offline	Riser3 marked as offline after 30 seconds without communication.	NA
178	RIS3 Unk	Riser3 reporting an unknown error.	NA
179	RIS3 POR Rst	Riser3 reporting a power-on reset error.	NA
180	RIS3 WDT Rst	Riser3 reporting a watchdog reset error.	NA
181	RIS3 BOD Rst	Riser3 reporting a brown-out reset error.	NA
182	RIS3 Group Net	Riser3 reporting a group network communication loss error.	NA
183	RIS3 Hall Net	Riser3 reporting a hall network communication loss error.	NA
184	RIS3 Car Net	Riser3 reporting an invalid error.	NA

Fault Number	Name	Definition	Solution
185	RIS3 Mst Net	Riser3 reporting an invalid error.	NA
186	RS1 Slv Net	Riser3 reporting an invalid error.	NA
187	RIS3 DIP	Riser3 has detected another board with the same address.	NA
188	RIS3 Bus Rst 1	Riser3 reporting a CAN1 bus reset error.	NA
189	RIS3 Bus Rst 2	Riser3 reporting a CAN2 bus reset error.	NA
190	RIS3 Inv Msg 1	NA	NA
191	RIS3 Inv Msg 2	NA	NA
192	RIS4 Offline	Riser4 marked as offline after 30 seconds without communication.	NA
193	RIS4 Unk	Riser4 reporting an unknown error.	NA
194	RIS4 POR Rst	Riser4 reporting a power-on reset error.	NA
195	RIS4 WDT Rst	Riser4 reporting a watchdog reset error.	NA
196	RIS4 BOD Rst	Riser4 reporting a brown-out reset error.	NA
197	RIS4 Group Net	Riser4 reporting a group network communication loss error.	NA
198	RIS4 Hall Net	Riser4 reporting a hall network communication loss error.	NA
199	RIS4 Car Net	Riser4 reporting an invalid error.	NA
200	RIS4 Mst Net	Riser4 reporting an invalid error.	NA
201	RS1 Slv Net	Riser4 reporting an invalid error.	NA
202	RIS4 DIP	Riser4 has detected another board with the same address.	NA
203	RIS4 Bus Rst 1	Riser4 reporting a CAN1 bus reset error.	NA

Fault Number	Name	Definition	Solution
204	RIS4 Bus Rst 2	Riser4 reporting a CAN2 bus reset error.	NA
205	RIS4 Inv Msg 1	NA	NA
206	RIS4 Inv Msg 2	NA	NA
1438	RIS1 HB Offline	Riser 1 has reported communication loss with one of its hall boards.	Check the hall board status menu for a hall board reporting 0% communication and check wiring.
1439	RIS2 HB Offline	Riser 2 has reported communication loss with one of its hall boards.	Check the hall board status menu for a hall board reporting 0% communication and check wiring.
1440	RIS3 HB Offline	Riser 3 has reported communication loss with one of its hall boards.	Check the hall board status menu for a hall board reporting 0% communication and check wiring.
1441	RIS4 HB Offline	Riser 4 has reported communication loss with one of its hall boards.	Check the hall board status menu for a hall board reporting 0% communication and check wiring.

43.4.10 Safety

The table below lists the alarms related to Safety.

Table 84: List of Alarms related to Safety

Fault Number	Name	Definition	Solution
1	NTS Up P1-1	NTS point 1 has been tripped in the up direction for the normal motion profile. The lowest point is closest to the terminal.	NA
2	NTS Up P1-2	NTS point 2 has been tripped in the up direction for the normal motion profile. The lowest point is closest to the terminal.	NA
3	NTS Up P1-3	NTS point 3 has been tripped in the up direction for the normal motion profile. The lowest point is closest to the terminal.	NA
4	NTS Up P1-4	NTS point 4 has been tripped in the up direction for the normal motion	NA

Fault Number	Name	Definition	Solution
		profile. The lowest point is closest to the terminal.	
5	NTS Up P1-5	NTS point 5 has been tripped in the up direction for the normal motion profile. The lowest point is closest to the terminal.	NA
6	NTS Up P1-6	NTS point 6 has been tripped in the up direction for the normal motion profile. The lowest point is closest to the terminal.	NA
7	NTS Up P1-7	NTS point 7 has been tripped in the up direction for the normal motion profile. The lowest point is closest to the terminal.	NA
8	NTS Up P1-8	NTS point 8 has been tripped in the up direction for the normal motion profile. The lowest point is closest to the terminal.	NA
9	NTS Up P2-1	NA	NA
10	NTS Up P2-2	NA	NA
11	NTS Up P2-3	NA	NA
12	NTS Up P2-4	NA	NA
13	NTS Up P2-5	NA	NA
14	NTS Up P2-6	NA	NA
15	NTS Up P2-7	NA	NA
16	NTS Up P2-8	NA	NA
17	NTS Up P3-1	NTS point 1 has been tripped in the up direction for the E-Power motion profile. The lowest point is closest to the terminal.	NA
18	NTS Up P3-2	NTS point 2 has been tripped in the up direction for the E-Power motion profile. The lowest point is closest to the terminal.	NA
19	NTS Up P3-3	NTS point 3 has been tripped in the up direction	NA

Fault Number	Name	Definition	Solution
		for the E-Power motion profile. The lowest point is closest to the terminal.	
20	NTS Up P3-4	NTS point 4 has been tripped in the up direction for the E-Power motion profile. The lowest point is closest to the terminal.	NA
21	NTS Up P3-5	NTS point 5 has been tripped in the up direction for the E-Power motion profile. The lowest point is closest to the terminal.	NA
22	NTS Up P3-6	NTS point 6 has been tripped in the up direction for the E-Power motion profile. The lowest point is closest to the terminal.	NA
23	NTS Up P3-7	NTS point 7 has been tripped in the up direction for the E-Power motion profile. The lowest point is closest to the terminal.	NA
24	NTS Up P3-8	NTS point 8 has been tripped in the up direction for the E-Power motion profile. The lowest point is closest to the terminal.	NA
25	NTS Up P4-1	NTS point 1 has been tripped in the up direction for the Short motion profile. The lowest point is closest to the terminal.	NA
26	NTS Up P4-2	NTS point 2 has been tripped in the up direction for the Short motion profile. The lowest point is closest to the terminal.	NA
27	NTS Up P4-3	NTS point 3 has been tripped in the up direction for the Short motion	NA

Fault Number	Name	Definition	Solution
		profile. The lowest point is closest to the terminal.	
28	NTS Up P4-4	NTS point 4 has been tripped in the up direction for the Short motion profile. The lowest point is closest to the terminal.	NA
29	NTS Up P4-5	NTS point 5 has been tripped in the up direction for the Short motion profile. The lowest point is closest to the terminal.	NA
30	NTS Up P4-6	NTS point 6 has been tripped in the up direction for the Short motion profile. The lowest point is closest to the terminal.	NA
31	NTS Up P4-7	NTS point 7 has been tripped in the up direction for the Short motion profile. The lowest point is closest to the terminal.	NA
32	NTS Up P4-8	NTS point 8 has been tripped in the up direction for the Short motion profile. The lowest point is closest to the terminal.	NA
33	NTS Dn P1-1	NTS point 1 has been tripped in the down direction for the normal motion profile. The lowest point is closest to the terminal.	NA
34	NTS Dn P1-2	NTS point 2 has been tripped in the down direction for the normal motion profile. The lowest point is closest to the terminal.	NA
35	NTS Dn P1-3	NTS point 3 has been tripped in the down direction for the normal	NA

Fault Number	Name	Definition	Solution
		motion profile. The lowest point is closest to the terminal.	
36	NTS Dn P1-4	NTS point 4 has been tripped in the down direction for the normal motion profile. The lowest point is closest to the terminal.	NA
37	NTS Dn P1-5	NTS point 5 has been tripped in the down direction for the normal motion profile. The lowest point is closest to the terminal.	NA
38	NTS Dn P1-6	NTS point 6 has been tripped in the down direction for the normal motion profile. The lowest point is closest to the terminal.	NA
39	NTS Dn P1-7	NTS point 7 has been tripped in the down direction for the normal motion profile. The lowest point is closest to the terminal.	NA
40	NTS Dn P1-8	NTS point 8 has been tripped in the down direction for the normal motion profile. The lowest point is closest to the terminal.	NA
41	NTS Dn P2-1	NA	NA
42	NTS Dn P2-2	NA	NA
43	NTS Dn P2-3	NA	NA
44	NTS Dn P2-4	NA	NA
45	NTS Dn P2-5	NA	NA
46	NTS Dn P2-6	NA	NA
47	NTS Dn P2-7	NA	NA
48	NTS Dn P2-8	NA	NA

Fault Number	Name	Definition	Solution
49	NTS Dn P3-1	NTS point 1 has been tripped in the down direction for the E-Power motion profile. The lowest point is closest to the terminal.	NA
50	NTS Dn P3-2	NTS point 2 has been tripped in the down direction for the E-Power motion profile. The lowest point is closest to the terminal.	NA
51	NTS Dn P3-3	NTS point 3 has been tripped in the down direction for the E-Power motion profile. The lowest point is closest to the terminal.	NA
52	NTS Dn P3-4	NTS point 4 has been tripped in the down direction for the E-Power motion profile. The lowest point is closest to the terminal.	NA
53	NTS Dn P3-5	NTS point 5 has been tripped in the down direction for the E-Power motion profile. The lowest point is closest to the terminal.	NA
54	NTS Dn P3-6	NTS point 6 has been tripped in the down direction for the E-Power motion profile. The lowest point is closest to the terminal.	NA
55	NTS Dn P3-7	NTS point 7 has been tripped in the down direction for the E-Power motion profile. The lowest point is closest to the terminal.	NA

Fault Number	Name	Definition	Solution
56	NTS Dn P3-8	NTS point 8 has been tripped in the down direction for the E-Power motion profile. The lowest point is closest to the terminal.	NA
57	NTS Dn P4-1	NTS point 1 has been tripped in the down direction for the Short motion profile. The lowest point is closest to the terminal.	NA
58	NTS Dn P4-2	NTS point 2 has been tripped in the down direction for the Short motion profile. The lowest point is closest to the terminal.	NA
59	NTS Dn P4-3	NTS point 3 has been tripped in the down direction for the Short motion profile. The lowest point is closest to the terminal.	NA
60	NTS Dn P4-4	NTS point 4 has been tripped in the down direction for the Short motion profile. The lowest point is closest to the terminal.	NA
61	NTS Dn P4-5	NTS point 5 has been tripped in the down direction for the Short motion profile. The lowest point is closest to the terminal.	NA
62	NTS Dn P4-6	NTS point 6 has been tripped in the down direction for the Short motion profile. The lowest point is closest to the terminal.	NA

Fault Number	Name	Definition	Solution
63	NTS Dn P4-7	NTS point 7 has been tripped in the down direction for the Short motion profile. The lowest point is closest to the terminal.	NA
64	NTS Dn P4-8	NTS point 8 has been tripped in the down direction for the Short motion profile. The lowest point is closest to the terminal.	NA
65	NTS Invalid P1	Normal profile NTS points are not of increasing in position/speed value or a trip speed exceeds contract speed.	Cycle power to the system or edit a Digital S-curve Technology™ (U.S. Patent Pending) parameter to trigger a NTS point recalculation.
66	NTS Invalid P2	Inspection profile NTS points are not of increasing in position/speed value or a trip speed exceeds contract speed.	Cycle power to the system or edit a Digital S-curve Technology™ (U.S. Patent Pending) parameter to trigger a NTS point recalculation.
67	NTS Invalid P3	Emergency profile NTS points are not of increasing in position/speed value or a trip speed exceeds contract speed.	Cycle power to the system or edit a Digital S-curve Technology™ (U.S. Patent Pending) parameter to trigger a NTS point recalculation.
68	NTS Invalid P4	Short profile NTS points are not of increasing in position/speed value or a trip speed exceeds contract speed.	Cycle power to the system or edit a Digital S-curve Technology™ (U.S. Patent Pending) parameter to trigger a NTS point recalculation.
116	Inv Man Run Lock	Manual run request rejected due to invalid hall lock state.	NA
117	Inv Man Run Arm	Manual run request rejected due to disarmed direction inputs. This may occur if car enters	NA

Fault Number	Name	Definition	Solution
		inspection with its direction inputs active.	

43.4.11 Speed

The table below lists the alarms related to Speed.

Table 85: List of Alarms related to Speed

Fault Number	Name	Definition	Solution
1460	Invalid Buffer Speed	While attempting to do the Buffer Test, Buffer speed is 0 or less than Learn Speed.	Set the Buffer Speed to a higher FPM (Contract Speed or above Learn Speed).
1461	Invalid Asc/Des Speed	While attempting to do the Asc/Des Overspeed test, Asc/Des speed is 0 or less than Learn Speed.	Set the Asc/Des speed to a higher FPM (Contract Speed or above Learn Speed).
1523	SLWDN LRN T/O	The car has failed to slow down to configured leveling speed during a slowdown learn within 10 seconds of cutting the high-speed valve. Set the car's leveling speed parameter to above the car's max leveling valve speed.	This alarm is for identifying when the car's leveling speed is not set above the car's leveling speed.

List of Abbreviations

ADA	America's with Disabilities Act
CCB	Car Call Button
COP	Car Operating Panel
CT	Car Top
DC	Door Close
DO	Door Open
DOL	Door Open Limit
DZ	Door Zone
EMS	Emergency Medical Services
GSW	Gate Switch
GUI	Graphical User Interface
HA	Hoistway Access
LWD	Load Weighing Device
MR	Machine Room
NTS	Normal Terminal Stop
ODL	Overspeed Debounce Limit
OMF	Opening Map Front
OMR	Opening Map Rear
OOS	Out Of Service
PI	Position Indicator
SM	Start Motor
SMF	Security Mask Front
SMR	Security Mask Rear
SRU	Smartrise Universal
TSRD	Terminal Stopping Distance
UI	User Interface

References

Smartrise's Hydro:Evolved Manuals: <https://www.smartrise.us/support/hydroevolved-support/>

Smartrise's Hydro:Evolved Training Videos: <https://www.smartrise.us/support/c4-training-videos/>